

MACHEREY-NAGEL

Chromatography



Columns and supplies



MACHEREY-NAGEL

www.mn-net.com



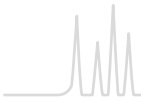

Contents 4



Solid phase extraction 8



Sample filtration 80



Vials and caps 96



Liquid chromatography 142



Thin layer chromatography 264



Gas chromatography 298

Appendices 374

MACHEREY-NAGEL – About us

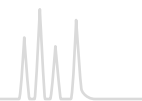

Quality since 1911

Since 1911 MACHEREY-NAGEL stands for high quality, innovation and reliability in chemical and biomolecular analysis. Friendly expert advice for our highly valued customers as well as outstanding product quality have been the cornerstones of our corporate success for more than 100 years. MACHEREY-NAGEL

is a family-owned company run by the fourth generation. As one of today's leading manufacturers of products for analytical chemistry and life science we offer a broad range of products for Filtration, Rapid Tests, Water Analysis, Chromatography and Bioanalysis.



Filtration



Rapid Tests



Water Analysis



Chromatography



Bioanalysis

MACHEREY-NAGEL – worldwide

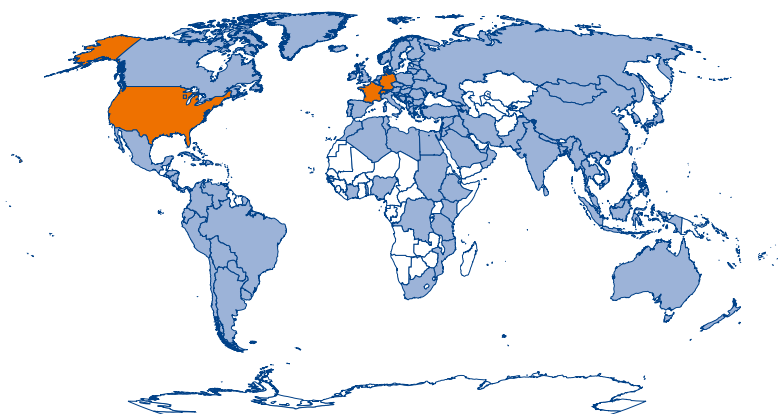

Our customers can count on competent and reliable service all over the world.

- Headquarters and manufacturing site in Düren (Germany), further location in Oensingen (Switzerland)
- Globally operating network of qualified and specially trained distributors in more than 150 countries
- Branches in France, Switzerland and the United States with dedicated and expert staff

For a complete list of branches and authorized distributors see www.mn-net.com/distributor

1952



MN launches the first products for paper chromatography

1970



Expansion of the product range by column chromatography

1982



Fused silica capillary columns for GC

1961



MACHEREY-NAGEL becomes one of the pioneers in TLC

1974



NUCLEOSIL® – one of the first spherical HPLC silicas leads to our core competence in silica technology

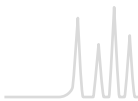

MACHEREY-NAGEL – Chromatography

MACHEREY-NAGEL Chromatography – Complete solutions for your analysis

MACHEREY-NAGEL has grown from a pioneer in chromatography to a full-range supplier of laboratory consumables. We supply laboratories all over the world with HPLC, GC and SPE columns, TLC plates and sheets, syringe filters or suitable vials and closures. Our philosophy includes personal and competent

support as well as outstanding product quality. We have the demand to fulfill the customer's individual needs and offer optimal and reliable solutions for your lab work in method development and routine analysis.

How you can benefit from MACHEREY-NAGEL

- Competent and individual service
- More than 50 years of expertise in manufacturing of chromatographic adsorbents
- Comprehensive product portfolio covering all areas of chromatography consumables

MN on the internet

- Detailed product information and technical data can be found at www.mn-net.com
- Online application database with more than 3000 practical applications www.mn-net.com/apps
- Safety data sheet, certificates of analysis, instruction leaflets, flyers and catalogs can be downloaded online
- VialFinder: Your alternative! Easy selection by updated cross references
- FilterFinder: Always the suitable syringe filter - directly from the manufacturer
- HPLC and GC troubleshooting online
- You can find MACHEREY-NAGEL also on exhibitions www.mn-net.com/tradeshows



SPE and Flash



Syringe filters



Vials and caps



HPLC



TLC



GC

1987



CHROMABOND® columns for SPE

2002



NUCLEODUR® high purity spherical silica for HPLC

2011



NUCLEOSHELL® core-shell silica for highest efficiency in HPLC

1994



OPTIMA® capillary columns for optimal GC separations

2007



CHROMAFIL® Xtra the syringe filters for sample preparation

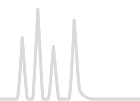

Solid phase extraction

Basics.....	10
CHROMABOND® hardware	14
CHROMABOND® summary of MN phases.....	16
Method development kits.....	18
CHROMABOND® HR- <i>Xpert</i>	19
CHROMABOND® polymer phases · others	29
CHROMABOND® reversed phases	32
CHROMABOND® normal phases.....	39
CHROMABOND® ion exchangers	45
Special phases · pharmac. applications	48
Special phases · environmental analysis.....	51
Special phases · food analysis	57
Special phases · others.....	61
SPE vacuum manifolds and accessories	65
Empty columns and accessories.....	67
High throughput SPE	68
Flash chromatography	71
CHROMABOND® Flash RS.....	74
CHROMABOND® Flash BT · DL.....	76
CHROMABOND® Flash FM.....	77
CHROMABOND® Flash connecting kits	78
Flash glass columns and accessories	79



Sample filtration

Basics.....	82
Selection guide for syringe filters	84
CHROMAFIL® combi filters	85
CHROMAFIL® syringe filters.....	86
Chemical compatibility of CHROMAFIL®	93
CHROMAFIL® filtration cartridges · MULTI 96.....	94



Vials and caps

Basics.....	98
Crimp neck vials and caps N 8.....	101
Screw neck vials and caps N 8	102
Screw neck vials and caps N 9	104

Screw neck vials and caps N 10	108
Crimp neck vials and caps N 11.....	109
Snap ring vials and caps N 11.....	114
Crimp neck vials and caps N 13.....	118
Screw neck vials and caps N 13	119
Special vials and caps.....	120
Screw neck vials for storage of liquid samples.....	120
Snap cap vials for storage of powdery samples	123
Shell vials N 8 and N 12	124
Screw neck vials / magnetic screw caps N 18	125
Crimp neck vials and caps N 20.....	126
Screw neck vials and caps N 24	131
Containers / Vial racks	133
Crimping tools	134
Autosampler compatibility	136



Liquid chromatography

Basics.....	144
USP listing	148
NUCLEODUR® high purity silica for HPLC.....	150
NUCLEODUR® for UHPLC.....	151
NUCLEODUR® phase overview	152
NUCLEODUR® columns	158
NUCLEOSHELL® core-shell silica for HPLC	192
NUCLEOSHELL® phase overview	198
NUCLEOSHELL® columns.....	200
NUCLEOSIL® standard silica for HPLC	211
NUCLEOSIL® phase overview.....	212
NUCLEOSIL® columns.....	214
Analytical columns with LiChrospher®	225
Phase overview for special separations	226
HPLC columns for environmental analyses.....	227
HPLC columns for enantiomer separations	231
HPLC columns for biochemical separations	237
HPLC columns for sugar analyses.....	246
Columns for gel permeation chromatography.....	249
MN column systems	250

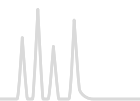

Accessories	254
Packings for preparative applications:	
NUCLEODUR® high purity silica for HPLC	256
POLYGOSIL® irregular silica for HPLC	257
POLYGOPREP irregular silica for HPLC	258
Adsorbents for column chromatography	260



Thin layer chromatography

Basics	266
Introductory kits	269
Summary of MN ready-to-use layers	272
Unmodified TLC silica layers	274
Silica layers with concentrating zone	278
Unmodified HPTLC silica layers	280
Modified silica layers	283
Further layers	288
Layers for special TLC separations	291
Chromatography papers	294
Accessories	295
Reagents	296
Adsorbents	297



Gas chromatography

Basics	300
USP listing	302
Additional information for GC columns	303
Separation properties of OPTIMA® phases	305
Summary of MN phases for GC	306
OPTIMA® · nonpolar capillary columns	310
OPTIMA® · weakly polar capillary columns	314
OPTIMA® δ · phases with autoselectivity	318
OPTIMA® · medium polar capillary columns	321
OPTIMA® · polar capillary columns	328
PERMABOND® capillary columns	336
Special GC columns overview	339
Capillary columns for Fast GC	340
Capillary columns for enantiomer separation	342

Capillary columns for biodiesel analysis	346
Capillary columns for triglyceride analysis	348
Capillary columns for high temperature GC	349
Capillary columns for amine separation	350
Capillary columns for hydrocarbons	352
Capillary columns for silane · DEG.....	354
Fused silica capillaries	355
Reagents / methods for derivatization.....	357
Reagents / methods for acylation.....	359
Reagents / methods for alkylation / methylation.....	361
Reagents / methods for silylation	362
Derivatization procedures.....	367
Test mixtures for GC capillary columns.....	368
Ferrules for capillary columns	370
Septa for capillary column.....	371
Accessories for capillary columns	372
General accessories.....	373

Appendices

Index of reference numbers.....	374
List of abbreviations	391
Trademarks	393
List of literature	396

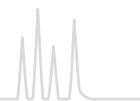



Contents

Basics.....	10
CHROMABOND® hardware	14
CHROMABOND® summary of MN phases.....	16
Method development kits.....	18
CHROMABOND® HR- <i>Xpert</i>	19
CHROMABOND® polymer phases · others.....	29
CHROMABOND® reversed phases	32
CHROMABOND® normal phases	39
CHROMABOND® ion exchangers	45
Special phases · pharmac. applications	48
Special phases · environmental analysis.....	51
Special phases · food analysis	57
Special phases · others.....	61
SPE vacuum manifolds and accessories	65
Empty columns and accessories.....	67
High throughput SPE	68
Flash chromatography.....	71
CHROMABOND® Flash RS	74
CHROMABOND® Flash BT · DL.....	76
CHROMABOND® Flash FM.....	77
CHROMABOND® Flash connecting kits	78
Flash glass columns and accessories.....	79

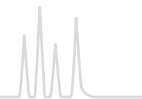

Solid phase extraction (SPE) is a powerful method for sample preparation and is used by most chromatographers today.

About 25 years ago MACHEREY-NAGEL designed and introduced CHROMABOND® SPE cartridges containing silica-based adsorbents. Since then we have developed the widest range of phases and products for SPE based on silica and polymeric materials.

SPE has capabilities in a broad range of applications

- Environmental analysis
- Pharmaceutical and biochemical analysis
- Organic chemistry
- Food analysis

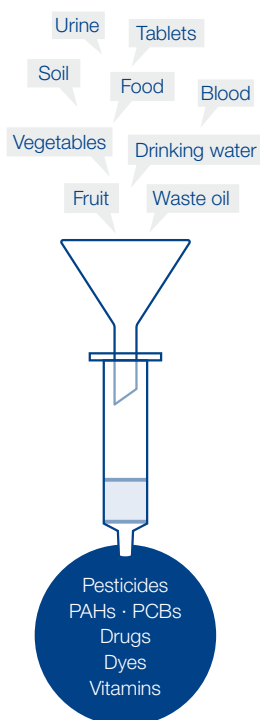

SPE is a form of digital (step-wise) chromatography designed to extract, partition, and / or adsorb one or more components from a liquid phase (sample) onto a stationary phase (adsorbent or resin). An adsorbed substance can be removed from the adsorbent by stepwise increase of elution strength of the eluent (step gradient technique). SPE extends a chromatographic system's lifetime, improves qualitative and quantitative analysis, and the demand placed on an analytical instrument is considerably lessened.

In general, SPE is used for three important purposes in state-of-the-art analysis

- Concentration of the analyte – up to factor 10.000 - increase of chromatographic sensibility and improved limits of detection
- Removal of interfering compounds – protection of subsequent analysis like HPLC, GC, TLC, UV or IR spectroscopy, ...
- Changing an analyte's environment to a simpler matrix more suitable for subsequent analysis

Advantages of SPE compared to classical liquid-liquid extraction

- Lower consumption of solvents
- Faster – enormous time savings
- Lower costs per sample
- Potential for automation
- High consistency in individual sample handling
- More specific selectivity because of the broad range of adsorbents and different retention mechanisms
- Optimization of extraction by the variation or adjusting of the solid phase and chromatographic conditions

Separation of food additives

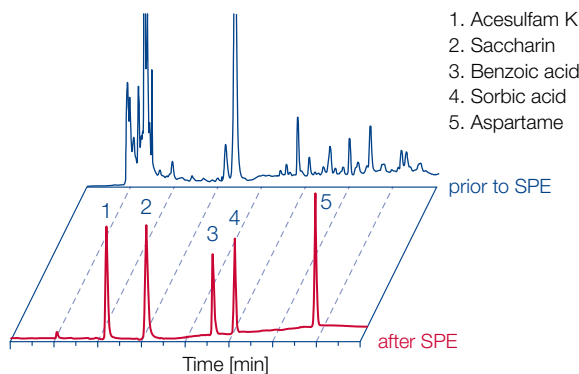

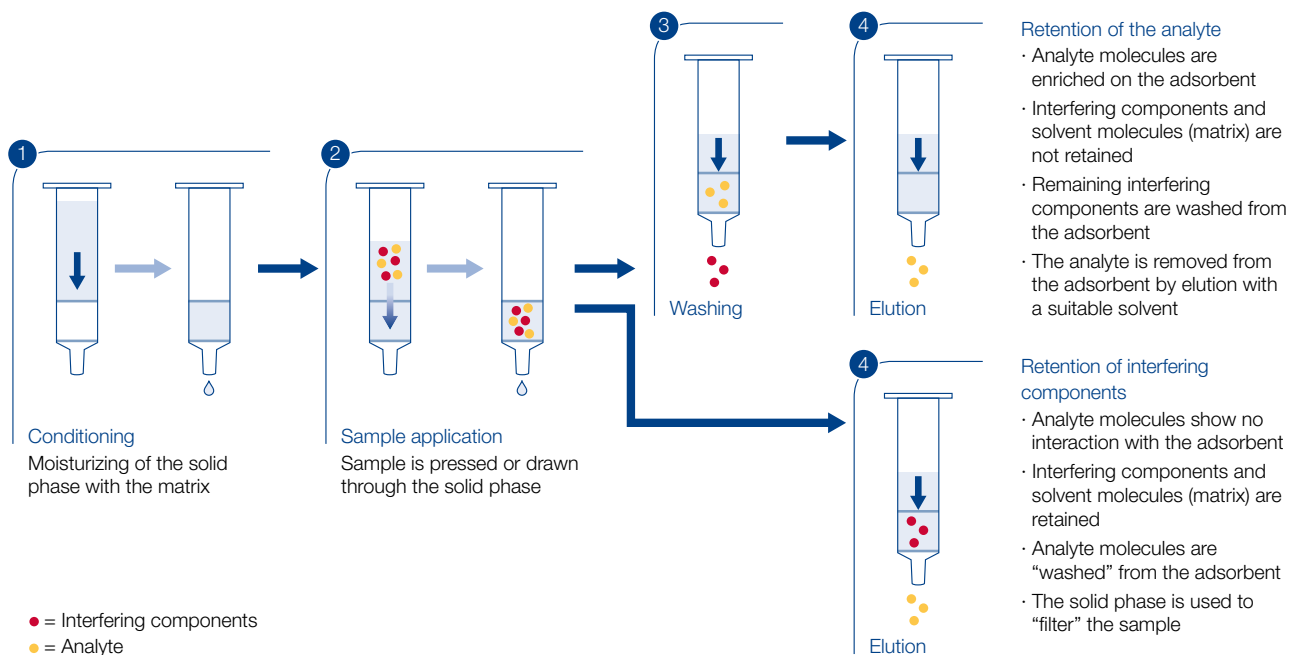

Since analytes can either be adsorbed on the SPE packing material or directly flown through while the interfering substances are retained, two general separation procedures are possible – both cases are shown in the figure above.

Main steps of the SPE procedure

① Conditioning of the adsorbent

Conditioning of the adsorbent is necessary in order to ensure reproducible interaction with the analyte. Conditioning, also called solvation, results in a wetting of the adsorbent and thus produces an environment, which is suitable for adsorption of the analyte. Nonpolar adsorbents are usually conditioned with 2–3 column volumes of a solvent, which is miscible with water (methanol, THF, 2-propanol etc.), followed by the solvent in which the analyte is dissolved (pure matrix, e.g., water, buffer). Polar adsorbents are conditioned with nonpolar solvents.

After the conditioning step the adsorbent bed must not run dry, because otherwise solvation is destroyed (deconditioning).

② Sample application (adsorption)

Sample application can be performed with positive or negative pressure with a flow rate of ~3 mL/min. Sample volumes vary from a few mL up to liters.

③ Washing of the adsorbent

Washing of the adsorbent is usually achieved with a special wash solution; however, in some cases it may not be necessary. If the polarity difference between wash solution and eluent is very large, or if both are not miscible, drying of the adsorbent bed after washing is recommended to improve elution and recovery.

④ Elution

Elution with a suitable eluent should not be too fast. The elution speed depends on the column or cartridge dimension and the quantity of adsorbent (about 1 mL/min).

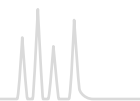

Molecular interactions in SPE

SPE adsorbents are most commonly categorized by the nature of their primary interaction mechanism with the analyte of interest. The three most common extraction mechanisms used in SPE are reversed phase (RP), normal phase (NP) and ion exchange.

Typical extraction mechanisms

- Reversed phase extraction of hydrophobic or polar organic analytes from aqueous matrix
- Normal phase extraction of polar analytes from nonpolar organic solvents
- Ion exchange extraction of charged analytes from aqueous or nonpolar organic samples

Types of retention mechanisms

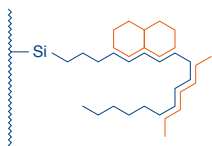

Nonpolar interactions

Silica-based: C₁₈ ec, C₁₈, C₁₈ Hydra, C₈
 Polymer-based: HR-X, HR-P, Easy, PS-RP
 Interactions: hydrophobic
 Sample: mostly aqueous
 Elution: solvents with lower polarity (compared to water)
 CH₃OH, CH₂Cl₂, CHCl₃, hexane

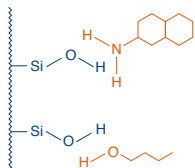

Polar interactions

Silica-based: SiOH, CN, NH₂, OH (diol), C₆H₅
 Other: Alox, Florisil®
 Interactions: hydrogen bonds, dipole-dipole and π-π interactions
 Sample: mostly organic
 Elution: polar solvents (compared to sample solvent), e.g., (nonprotic) ethers, ketones (MTBE, THF, acetone), CH₂Cl₂, CHCl₃

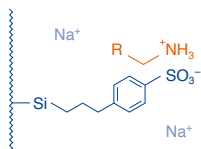

Cation exchangers

Silica-based: SA (SCX), PCA (WCX), PSA
 Polymer-based: HR-XC, HR-XCW, PS-H⁺
 Interaction: between charged analytes and functional group of cation exchanger
 Sample: aqueous (pH 3–5)
 Elution: acidic: pH 2 (e.g., HCl, or 20 % AcOH in CH₃OH – CH₃CN)
 basic: pH 8–9 (e.g., 5 % NH₃ in CH₃OH – CH₃CN) solvents or buffers with higher ionic strength and counter ions with high selectivity (e.g., Ca²⁺)

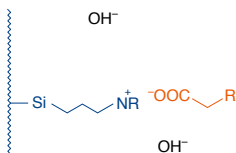

Anion exchangers

Silica-based: SB (SAX), NH₂
 Polymer-based: HR-XA, HR-XAW, PS-OH⁻
 Interaction: between charged analytes and functional group of anion exchanger
 Sample: aqueous (pH 8–9)
 Elution: basic: pH 10 (e.g., 20 % NH₃ in CH₃OH – CH₃CN)
 acidic: pH 4–5 (e.g., HCl, or 5 % AcOH in CH₃OH – CH₃CN) solvents or buffers with higher ionic strength and counter ions with high selectivity (e.g., citrate)

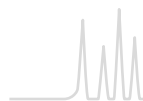

It should be noted, that in SPE the interactions described on page 12 are not found in pure form, but in combination. For example, modified silicas, unless they have been subjected to

endcapping (silanization of residual silanol groups with short-chain silanes), still possess free silanol groups, which can enter into secondary interactions.

Sample pretreatment

For direct extraction with adsorbents the sample matrix (sample environment) has to fulfill three conditions:

- The matrix has to be liquid, if possible with low viscosity
- Solids should be removed from the liquid matrix
- The matrix (sample environment) should be suitable for retention of the analyte

For solid samples there are different methods to convert the sample into a suitable matrix:

- Dissolution of the solid sample in a suitable solvent
- Lyophilization of the sample and dissolution in a suitable solvent
- Extraction of the solid sample with a suitable solvent
- Homogenization of the sample in a suitable solvent

In order to find the suitable solvent, one has to consider all desired sample components. Also, the suitable solvent should enhance retention of the analyte. For example, samples with large contents of solids are often homogenized in nonpolar solvents like hexane, while for samples with high water content dissolution in acids, bases, buffers or very polar solvents such as methanol is recommended.

Additionally, SPE allows to alter the properties of the sample matrix. If, for example, natural products are extracted with methanol or acetone, the polarity of the extracts can be increased by dilution with water, in order to enhance nonpolar solid phase extraction on the C₁₈ material.

Our CHROMABOND® QC policy

- Highest production standard – our facilities are EN ISO 9001:2008 certified
- All products are individually tested to meet our strict quality specifications, ensuring our outstanding product reproducibility, reliability and performance
- Perfect reproducibility from lot-to-lot and within every single batch:
 - Careful attention to particle size distribution and pore diameters assures consistent column flow
 - Chemical reproducibility is guaranteed by strict quality control throughout manufacturing
- Each product is supplied with a certificate of analysis stating the results of internal examinations and quality control

MACHEREY-NAGEL		MN																				
Certificate of analysis																						
Phase:	CHROMABOND® HR-X																					
Sorbent LOT:	0416/2																					
Technical Data																						
Material:	porous adsorptive resin based on polystyrene-divinylbenzene																					
Description:	yellow powder																					
Parameter	Specification	Result																				
Pore Diameter:	50 - 70 Å	56																				
Particle Size - 50 % Volume:	85 - 95 µm	83																				
Surface Area (m ² /g):	> 950	1034																				
Capacity (mg caffeine/g sorbent):	>250	453																				
The packing quantity varies ± 5 % referred to the amount given on the label or in the catalogue.																						
Confirmation																						
Hereby we confirm that the above mentioned product has successfully passed our quality control system in accordance with ISO 9001:2008 and meets the specific quality criteria.																						
This document has been produced electronically and is valid without a signature.																						
Visit our Online Application Database: www.mn-net.com/apps																						
3000 free chromatography applications – without registration																						
... find Your application!																						
<table border="0"> <tr> <td>MACHEREY-NAGEL GmbH & Co. KG</td> <td>Neumann-Neander Str. 6-8</td> <td>92705 Eiken</td> <td>Germany</td> </tr> <tr> <td>US</td> <td>Interscience</td> <td>CH</td> <td>FR</td> </tr> <tr> <td>Tel: +49 24 21 980-0</td> <td>Tel: +41 62 288 55 00</td> <td>Tel: +33 388 99 22 08</td> <td>Tel: +1 464 821 0394</td> </tr> <tr> <td>Fax: +49 24 21 988 100</td> <td>Fax: +41 62 288 55 05</td> <td>Fax: +33 388 91 15 00</td> <td>Fax: +1 464 821 0772</td> </tr> <tr> <td>E-mail: info@mn-net.com</td> <td>E-mail: sales-ch@mn-net.com</td> <td>E-mail: sales-fr@mn-net.com</td> <td>E-mail: sales-us@mn-net.com</td> </tr> </table>			MACHEREY-NAGEL GmbH & Co. KG	Neumann-Neander Str. 6-8	92705 Eiken	Germany	US	Interscience	CH	FR	Tel: +49 24 21 980-0	Tel: +41 62 288 55 00	Tel: +33 388 99 22 08	Tel: +1 464 821 0394	Fax: +49 24 21 988 100	Fax: +41 62 288 55 05	Fax: +33 388 91 15 00	Fax: +1 464 821 0772	E-mail: info@mn-net.com	E-mail: sales-ch@mn-net.com	E-mail: sales-fr@mn-net.com	E-mail: sales-us@mn-net.com
MACHEREY-NAGEL GmbH & Co. KG	Neumann-Neander Str. 6-8	92705 Eiken	Germany																			
US	Interscience	CH	FR																			
Tel: +49 24 21 980-0	Tel: +41 62 288 55 00	Tel: +33 388 99 22 08	Tel: +1 464 821 0394																			
Fax: +49 24 21 988 100	Fax: +41 62 288 55 05	Fax: +33 388 91 15 00	Fax: +1 464 821 0772																			
E-mail: info@mn-net.com	E-mail: sales-ch@mn-net.com	E-mail: sales-fr@mn-net.com	E-mail: sales-us@mn-net.com																			



Design of columns, cartridges and 96-well plates

All CHROMABOND® columns, cartridges and 96-well plates are manufactured from polypropylene (PP) with lowest content of extractables (plasticizers, stabilizers, ...) offering blank value free results when using most common solvents.

The high quality CHROMABOND® adsorbents are kept in place by chemically very inert polyethylene filter elements (PE, standard pore size 20 µm).

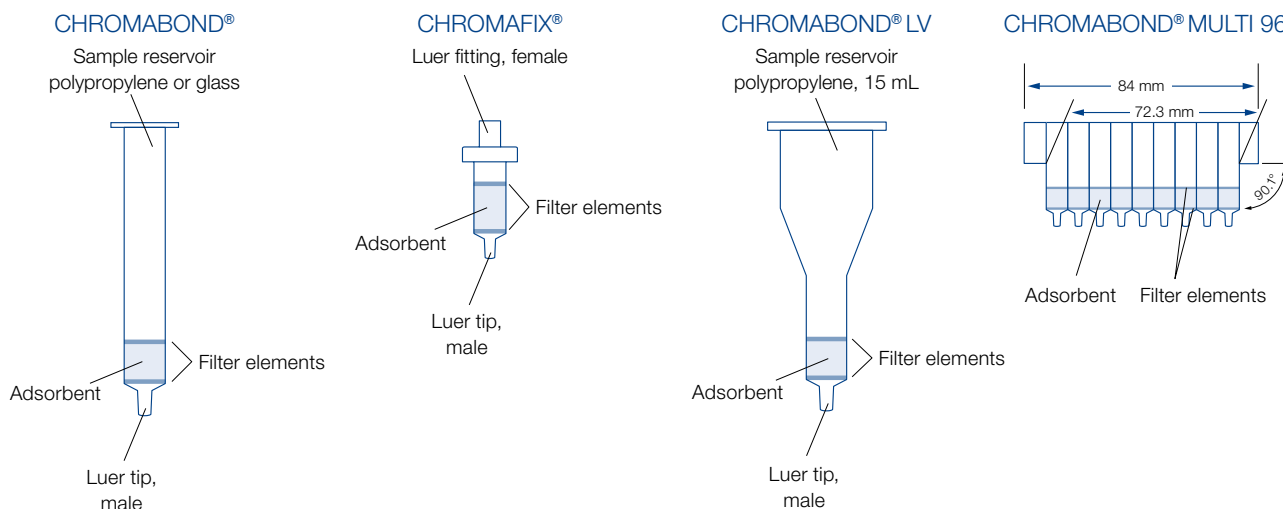

CHROMABOND® polypropylene columns

- PP columns with PE filter elements
- Different sizes from 1, 3, 6 up to 150 mL
- Adsorbent weights from 20 mg to 50 g
- Male Luer tip as exit
- Compatible with most robots (e.g., Gilson® ASPEC™, Caliper AutoTrace®)

CHROMABOND® glass columns

- Glass columns with chemically very inert glass fiber filter elements (nominal pore size 1 µm)
- Two different sizes: 3 and 6 mL
- Available with all CHROMABOND® phases
- Excludes any influence from the column material (e.g., plasticizers)

CHROMAFIX® cartridges

- PP cartridges with PE filter elements
- Three different sizes with different adsorbent weights: Small (0.4 mL), Medium (0.8 mL), Large (1.8 mL)
- Female Luer fitting at the inlet, male Luer tip as exit
- Offers alternative way of handling using positive pressure by syringes or peristaltic pumps
- Especially suited for convenient solid phase extraction of small sample volumes

CHROMABOND® LV columns

- Large volume PP columns with PE filter elements
- Three different adsorbent weights (100, 200 and 500 mg)
- Funnel-shaped reservoir with 15 mL volume
- Especially for clinical samples - the whole sample (e.g., urine, serum, blood) can be applied to the column in one step
- Can be directly used in the Zymate® lab robots of Zymark

CHROMABOND® MULTI 96 · SPE in 96-well format

- 96-well PP plates with PE filter elements
- Cavity volume 1.5 mL
- Adsorbent weights 10, 25, 50 and 100 mg
- Supplied with any CHROMABOND® SPE adsorbents
- For the simultaneous preparation of 96 samples
- Easy method transfer from CHROMABOND® columns or CHROMAFIX® cartridges to CHROMABOND® MULTI 96
- Readily adaptable to all common automated / robotic handling systems (for details see page 69)

On-line SPE (see page 68)

- Online columns and cartridges
- SPE columns with caps and needles for the Gerstel MultiPurposeSampler (MPS)
- Columns for Gilson® ASPEC™ systems (ASP)

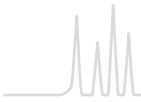

CHROMABOND® SPE columns from page 23 onwards



CHROMABOND® Multi 96 page 14 and 69



CHROMABOND® Flash RS page 75



CHROMABOND® Flash BT page 76



CHROMABOND® Flash DL page 76



CHROMABOND® Flash FM page 77



CHROMABOND® summary of MN phases

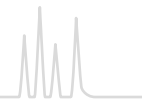

CHROMABOND® Phase	Matrix	Modification / Application	Similar phases*	Page
Reversed phases				
HR-X	PS/DVB		ENVI-Chrom P · Strata™-X · Oasis® HLB · Nexus	23
Easy	PS/DVB	polar, bifunctional	Strata™-X · Oasis® HLB · Porapak™ RDX · Nexus, Bond Elut® PPL, Focus™ · Styre Screen® DVB Bakerbond™ H ₂ O-philic DVB · Isolute® ENV+	29
HR-P	PS/DVB		Strata™ SDB-L · Bond Elut® ENV, Bond Elut® LMS · DSC-PS/DVB, ENV PS-DVB · Bakerbond™ H ₂ O-phobic DVB · Isolute® 101 · LiChrolut® EN	30
PS-RP	PS/DVB	removal of organic components	like HR-P	31
C ₁₈ ec	silica	octadecyl, endcapped	Strata™ C18-E · Sep-Pak® tC18 · Bond Elut® C18 · DSC-18(Lt), ENVI-18, LC-18 · CLEAN-UP® C18, Bakerbond™ Octadecyl · Isolute® C18(EC), LiChrolut® RP-18 E	32
C ₁₈ ec f	silica	as above, fast flow		32
C ₁₈	silica	octadecyl, not endcapped	Strata™ C18-U · AccuBond® C18 · Bakerbond™ PolarPlus · Isolute® C18 · LiChrolut® RP-18	33
C ₁₈ f	silica	as above, fast flow		33
C ₁₈ Hydra	silica	octadecyl, not endcapped, for polar analytes		34
C ₈	silica	octyl	Strata™ C8 · Sep-Pak® C8 · Bond Elut® C8 · DSC-8, ENVI-8, LC-8 · CLEAN-UP® C8 · AccuBond® C8 · Bakerbond™ Octyl · Isolute® C8(EC)	35
C ₄	silica	butyl		36
C ₂	silica	dimethyl	Bond Elut® C2	36
C ₆ H ₁₁ ec	silica	cyclohexyl, endcapped	Bond Elut® CH	37
C ₆ H ₅	silica	phenyl	Strata™ PH · Bond Elut® PH · DSC-Ph · CLEAN-UP® Phenyl · AccuBond® Phenyl · Bakerbond™ Phenyl · Isolute PH(EC)	38
Normal phases				
SiOH	silica	unmodified	Strata™ Si-1 · Bond Elut® silica · DSC-Si, LC-Si · CLEAN-UP® silica · AccuBond® silica, Bakerbond™ silica gel · Isolute® silica · LiChrolut® Si	39
NH ₂	silica	aminopropyl	Strata™ NH ₂ · Sep-Pak® NH ₂ · Bond Elut® NH ₂ · DSC-NH ₂ , LC-NH ₂ · CLEAN-UP® aminopropyl · AccuBond® NH ₂ · Bakerbond™ amino · Isolute® NH ₂ · LiChrolut® NH ₂	40
OH (Diol)	silica	diol	DSC-Diol, LC-Diol · AccuBond® Diol (OH)	41
CN	silica	cyano	Strata™ CN · Sep-Pak® CN · Bond Elut® CN-U · DSC-CN, LC-CN · CLEAN-UP® CN · AccuBond® CN · Bakerbond™ cyano · Isolute® CN · LiChrolut® CN	41
HILIC	silica	zwitterionic ammonium-sulfonic acid modification	ZIC® HILIC	42
Alox A	aluminum oxide	acidic	LC-Alumina-A · AccuBond® Aluminiumoxid A	43
Alox N	aluminum oxide	neutral	LC-Alumina-N · AccuBond® Aluminiumoxid N	43
Alox B	aluminum oxide	basic	LC-Alumina-B · AccuBond® Aluminiumoxid B	43
Florisil®	magnesium silicate		Strata™ FL-PR · Sep-Pak® Florisil® · Bond Elut® Florisil® · ENVI-Florisil® · LC-Florisil® · CLEAN-UP® Florisil® · AccuBond® Florisil® · Bakerbond™ Florisil® · Isolute® FL · LiChrolut® Florisil®	44
PA	polyamide 6		DPA-6S	44
Ion exchangers				
SA	silica	benzenesulfonic acid cation exchanger (SCX)	Strata™ SCX · Bond Elut® SCX · DSC-SCX, LC-SCX · CLEAN-UP® Benzenesulfonic Acid · AccuBond® SCX · Bakerbond™ Aromatic Sulfonic Acid · Isolute® SCX · LiChrolut® SCX	45
SB	silica	quaternary ammonium anion exchanger (SAX)	Strata™ SAX, Sep-Pak® SAX, Bond Elut® SAX · DSC-SAX, LC-SAX · CLEAN-UP® Quaternary Amine · AccuBond® SAX · Bakerbond™ Quaternary Amine · Isolute® SAX · LiChrolut® SAX	46
PCA	silica	propylcarboxylic acid cation exchanger (WCX)	Strata™ WCX · Bond Elut® CBA · DSC-WCX, LC-WCX · CLEAN-UP® Carboxylic Acid · Bakerbond™ Carboxylic Acid · Isolute® CBA	47
PSA**	silica	propylsulfonic acid cation exchanger	Isolute® SCX-2 · Bond Elut® PRS	47



CHROMABOND[®] summary of MN phases



CHROMABOND [®]				
Phase	Matrix	Modification / Application	Similar phases*	Page
HR-XC	PS/DVB	strong mixed mode cation exchanger for basic analytes (MCX)	Oasis [®] MCX · Strata [™] -X-C · HyperSep [™] Retain [™] -CX · Styre Screen [®] DBX	25
HR-XA	PS/DVB	strong mixed mode anion exchanger for acidic analytes (MAX)	Oasis [®] MAX · Strata [™] -X-A · HyperSep [™] Retain [™] -AX · Styre Screen [®] QAX	26
HR-XCW	PS/DVB	weak mixed mode cation exchanger for basic analytes (WCX)	Oasis [®] WCX · Strata [™] -X-CW	27
HR-XAW	PS/DVB	weak mixed mode anion exchanger for acidic analytes (WAX)	Oasis [®] WAX · Strata [™] -X-AW	28
PS-OH ⁻	PS/DVB	strong anion exchanger in OH ⁻ form		31
PS-H ⁺	PS/DVB	strong cation exchanger in H ⁺ form		31
PS-Mix	PS/DVB	mixture of PS-OH ⁻ and PS-H ⁺		31
PS-Ag ⁺	PS/DVB	strong cation exchanger in Ag ⁺ form		31
PS-Ba ²⁺	PS/DVB	strong cation exchanger in Ba ²⁺ form		31
Phases for special applications				
Drug	silica	bifunctional C ₈ /SA, for enrichment of drugs from urine	Strata [™] Screen-C · Bond Elut [®] Certify I · DSC-MCAX · Clean Screen [®] DAU · AccuBond [®] Evidex · Bakerbond [™] Narc-2 · Isolute [®] HCX · LiChrolut [®] TSC · HyperSep [™] Verify CX	48
Drug II	silica	bifunctional C ₈ /SB, for extraction of THC and derivatives and of acidic analytes from biological fluids	Strata [™] Screen-A · Bond Elut [®] Certify II · Clean Screen [®] THC · Bakerbond [™] Narc-1 · Isolute [®] HAX · HyperSep [™] Verify AX	49
Tetracycline	silica	special octadecyl phase, for enrichment of tetracyclines		50
HR-P-AOX	PS/DVB	for extraction of AOX from water (DIN 38409 – H22)		51
C ₁₈ PAH	silica	special octadecyl phase, for enrichment of PAHs from water	Bakerbond [™] Octadecyl Lightload	51
NH ₂ /C ₁₈	silica	combination phase for enrichment of PAHs from water		52
CN/SiOH	silica	combination phase for enrichment of PAHs from soil		52
Na ₂ SO ₄ /Florisil [®]		combination phase for extraction of hydrocarbons from water (DIN H-53 / ISO DIS 9377-4)		53
NAN	silica / AgNO ₃ + Na ₂ SO ₄	combination phase for enrichment of PCBs from sludge		54
SA/SiOH	silica	combination phase for enrichment of PCBs from waste oil	Bakerbond [™] PCB-N	55
SiOH-H ₂ SO ₄ /SA	silica	combination phase, used together with SiOH for enrichment of PCB from oil		56
QuEChERS / Diamino	silica	primary and secondary amine functions (PSA), for determination of pesticides in food samples (QuEChERS method)	Supelclean [™] PSA · Bond Elut [®] PSA	57
ABC18	silica	octadecyl, with ion exchange functions, for acrylamide analysis	Isolute [®] M-M (multimode)	60
Carbon A	activated carbon	determination of acrylamide from water according to DIN 38413-6	Bakerbond [™] Carbon · BEKOLut [®] Carbon SAC	60
PL		specially developed SPE phase for the preparation of bioanalytical samples	Ostro [™] · Phree [™] · HybridSPE [®] -Phospholipid	61
Dry	Na ₂ SO ₄	for drying organic samples		61
PTL/PTS	special membrane	phase separation		62
XTR	kieselguhr	liquid-liquid extraction	EXTrelut [®] · Chem Elut [™] · Hydromatrix [™] · Isolute [®] SLE +	63

* Phases which provide a similar selectivity based on chemical or physical properties (list not complete)

** For primary and secondary amine functions see QuEChERS / Diamino



Method development kits

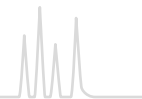

For the development kits as well as for all individual CHROMABOND®, CHROMABOND® LV and CHROMAFIX® types columns are sealed in units of five columns each to prevent adsorption of contaminants from the environment, e.g., laboratory air.

Designation	Contents of the kit	REF
Investigating the best separation mechanism for a clean-up procedure		
CHROMABOND® HR- <i>Xpert</i> development kit I	columns with 3 mL, 60 mg (particle size 45 µm): 10 columns with HR-X; 5 columns each with HR-XC, HR-XA, HR-XCW, HR-XAW	730723
CHROMABOND® HR- <i>Xpert</i> development kit II	columns with 3 mL, 200 mg (particle size 85 µm): 10 columns with HR-X; 5 columns each with HR-XC, HR-XA, HR-XCW, HR-XAW	730726
CHROMABOND® polymer development kit	5 columns each with 3 mL, 200 mg: HR-X, HR-XC (MCX), HR-XA (MAX), HR-P, Easy, PS-H ⁺ , PS-OH-	730288
CHROMABOND® standard development kit	5 columns each with 3 mL, 500 mg: C ₁₈ , C ₁₈ ec, C ₈ , C ₆ H ₅ , NH ₂ , DMA, OH (Diol), CN, SiOH, SA (SCX), SB (SAX)	730496
Selecting the optimum RP phase for a clean-up procedure		
CHROMABOND® RP development kit I	10 columns each with 3 mL, 500 mg: C ₁₈ , C ₁₈ ec, C ₈ , C ₄ and 10 columns each with 3 mL, 200 mg HR-P, HR-X	730197
CHROMABOND® RP development kit II	10 columns each with 1 mL, 100 mg: C ₁₈ , C ₁₈ ec, C ₈ , C ₄ , HR-P, HR-X	730207
CHROMAFIX® RP development kit I	10 cartridges each CHROMAFIX® S: C ₁₈ , C ₁₈ ec, C ₈ , C ₄ , HR-P, HR-X	731883
CHROMABOND® RP development kit III	10 columns each with 3 mL, 500 mg: C ₁₈ , C ₁₈ ec, C ₁₈ Hydra, C ₈ and 10 columns each with 3 mL, 200 mg HR-P, HR-X	730490
CHROMABOND® RP development kit IV	10 columns each with 1 mL, 100 mg: C ₁₈ , C ₁₈ ec, C ₁₈ Hydra, C ₈ , HR-P, HR-X	730491
CHROMAFIX® RP development kit II	10 cartridges each CHROMAFIX® S: C ₁₈ , C ₁₈ ec, C ₁₈ Hydra, C ₈ , HR-P, HR-X	731886
Selecting the optimum polar phase for a clean-up procedure		
CHROMABOND® polar development kit I	10 columns each with 3 mL, 500 mg: SiOH, Florisil®, NH ₂ , CN, OH (Diol)	730199
CHROMABOND® polar development kit II	10 columns each with 1 mL, 100 mg: SiOH, Florisil®, NH ₂ , CN, OH (Diol)	730208
CHROMAFIX® polar development kit	10 cartridges each CHROMAFIX® S: SiOH, Florisil®, NH ₂ , CN, OH (Diol)	731884
Selecting the optimum ion exchanger for a clean-up procedure		
CHROMABOND® ion exchange development kit I	10 columns each with 3 mL, 500 mg: SA (SCX), SB (SAX), HR-XC (MCX), HR-XA (MAX), PS-OH ⁺ , PS-H ⁺ , DMA	730206
CHROMABOND® ion exchange development kit II	10 columns each with 1 mL, 100 mg: SA (SCX), SB (SAX), HR-XC (MCX), HR-XA (MAX), PS-OH ⁺ , PS-H ⁺ , DMA	730209
CHROMAFIX® ion exchange development kit I	10 cartridges each CHROMAFIX® S: SA (SCX), SB (SAX), HR-XC (MCX), HR-XA (MAX), PS-OH ⁺ , PS-H ⁺ , DMA	731885
CHROMABOND® cation exchange development kit I	10 columns each with 3 mL, 500 mg: SA (SCX), PSA, PCA, HR-XC (MCX), HR-XCW (WCX), PS-H ⁺	730494
CHROMAFIX® cation exchange development kit	10 cartridges each CHROMAFIX® S: SA (SCX), PSA, PCA, HR-XC (MCX), HR-XCW (WCX), PS-H ⁺	731888
Phase selection for clean-up procedures for environmental samples		
CHROMABOND® kit I environmental sample preparation	10 columns each with 3 mL, 200 mg HR-P; 6 mL, 1000 mg C ₁₈ ec; 6 mL, 2000 mg C ₁₈ PAH; 6 mL, 500/1000 mg CN/SiOH; 3 mL, 500/500 mg SA/SiOH	730205
CHROMABOND® kit II environmental sample preparation	5 columns each with 3 mL, 500/500 mg SiOH-H ₂ SO ₄ /SA; 3 mL, 500 mg SiOH; 6 mL, 1000 mg Florisil®; 3 mL, 500/500 mg SA/SiOH; 6 mL, 700/2000/700 mg NAN	730349



The professional concept of innovative SPE phases

The CHROMABOND® HR-Xpert family comprises 5 polymer-based RP and mixed-mode ion exchange phases:

- CHROMABOND® HR-X hydrophobic PS/DVB copolymer
- CHROMABOND® HR-XC strong mixed-mode cation exchanger
- CHROMABOND® HR-XA strong mixed-mode anion exchanger
- CHROMABOND® HR-XCW weak mixed-mode cation exchanger
- CHROMABOND® HR-XAW weak mixed-mode anion exchanger

State-of-the-art spherical polymer

- Two particle sizes (45 µm and 85 µm) adequate for different sample volumes and matrices
- Broad spectrum of application with special suitability for the enrichment of pharmaceuticals from biological matrices
- Ideal flow properties due to low content of particulate matter

Optimized pore structure and high specific surface

- High loadability and outstanding elution properties
- Low solvent consumption
- Rapid, economical analysis

High-purity adsorber material

- Allows highest reproducibility with extremely low blind values
- Reliable analysis at ultra trace level
- No method adaptation for new batches necessary

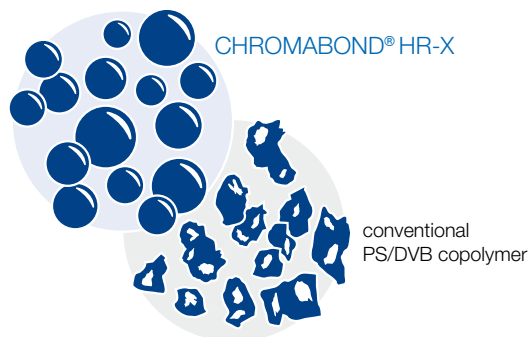

Adsorbent blind values:

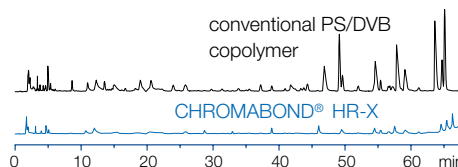

The HR-Xpert concept guarantees

- RP and mixed-mode SPE phases with distinct ion exchange and reversed phase properties: excellent enrichment of neutral, acidic and basic compounds
- Modern, spherical support polymer with optimized pore structure and high surface: good reproducibility, reliable and cost-efficient analysis
- Possibility for more aggressive washing procedures for matrix removal: cleaner samples and protection of your HPLC and GC instruments
- Quantification of analytes also from heavily contaminated samples: lower limits of detection also for critical matrices

CHROMABOND® HR-Xpert is the perfect combination for all tasks in sample preparation.

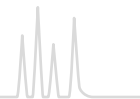

Chemical structures of the phases

CHROMABOND® HR-X

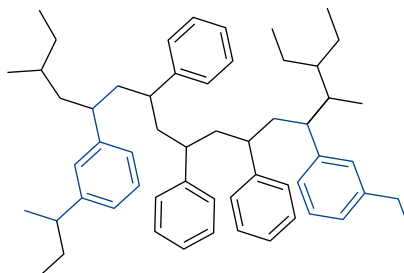

hydrophobic polystyrene-divinylbenzene copolymer
spherical base material for efficient enrichment
and ideal flow behavior

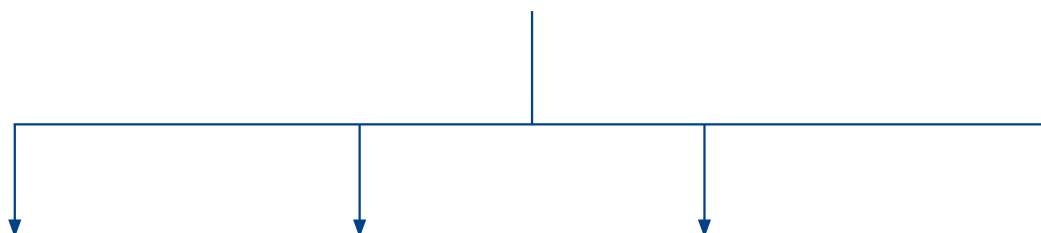

CHROMABOND® HR-XCW

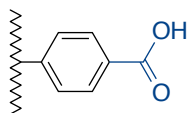

weak acidic
cation exchanger

CHROMABOND® HR-XA

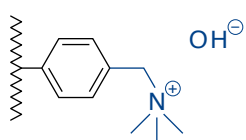

strong basic
anion exchanger

CHROMABOND® HR-XAW

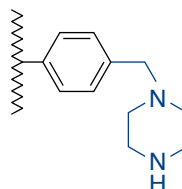

weak basic
anion exchanger

CHROMABOND® HR-XC

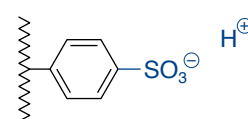

strong acidic
cation exchanger

Similar phases

CHROMABOND® HR-X:	Oasis® HLB, Strata™-X, Nexus, ENVI-Chrom P
CHROMABOND® HR-XC:	Oasis® MCX, Strata™-X-C, HyperSep™ Retain™-CX, StyreScreen® DBX
CHROMABOND® HR-XA:	Oasis® MAX, Strata™-X-A, HyperSep™ Retain™-AX, StyreScreen® QAX
CHROMABOND® HR-XCW:	Oasis® WCX, Strata™-X-CW
CHROMABOND® HR-XAW:	Oasis® WAX, Strata™-X-AW

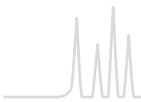

2 particle sizes - 1 goal: HR-Xpert for optimized sample preparation

For different application requirements the particle sizes complement each other perfectly.

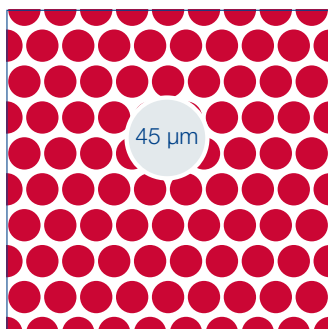

- Ideal for:
- Smaller sample volumes
 - Smaller adsorbent weights
 - Lower elution volumes

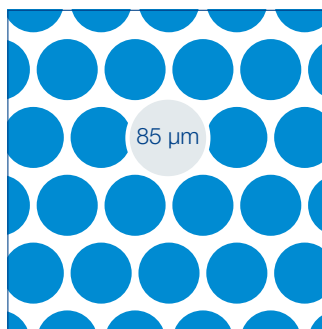

- Recommended for:
- Large volume or viscous samples, heavy matrix load
 - Operation without vacuum possible (e.g., for volatile analytes)
 - Higher adsorbent weight without increase in back pressure

Features of 45 µm particles

- About half the radius results in 8-fold particle number per volume for approx. equal adsorbent weight
- Same specific surface for both particle sizes: considerably larger freely accessible external surface for 45 µm particles
- Denser adsorbent packing: enhanced interaction of the analyte with the adsorbent, better extraction results

Ideal elution characteristics

Method: 1 mL column with 30 mg CHROMABOND® HR-X, 1 mL standard solution (1 mg/mL hexobarbital), drying, elution in portions of 100 µL with methanol (see application 305490 at www.mn-net.com/apps)

Recovery rates 45 µm

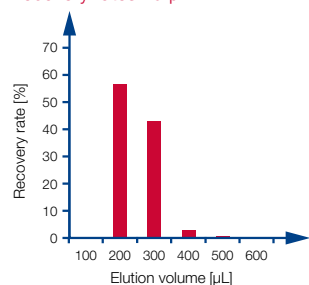

Advantages of 45 µm particles:

- Faster elution
- Lower elution volumes required

Recovery rates 85 µm

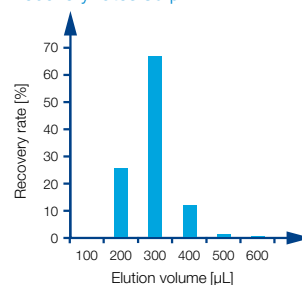

Breakthrough behavior in enrichment

Method: 1 mL column with 15 mg CHROMABOND® HR-X, apply portions of 1 mL standard solution (250 µg/mL hexobarbital in water), collect eluates (see application 305480 at www.mn-net.com)

45 µm (red) The analyte is completely retained up to fraction 10.

85 µm (blue) Small amounts even break through with fraction 4.

45 µm particles provide better enrichment and breakthrough behavior for small adsorbent weights. When using larger adsorbent weights this effect is less pronounced, since then analytes have sufficient contact with the 85 µm adsorbent particles as well.

45 µm particles are ideal for small sample and elution volumes, while for large amounts of sample and adsorbent 85 µm particles show advantages due to better flow properties.

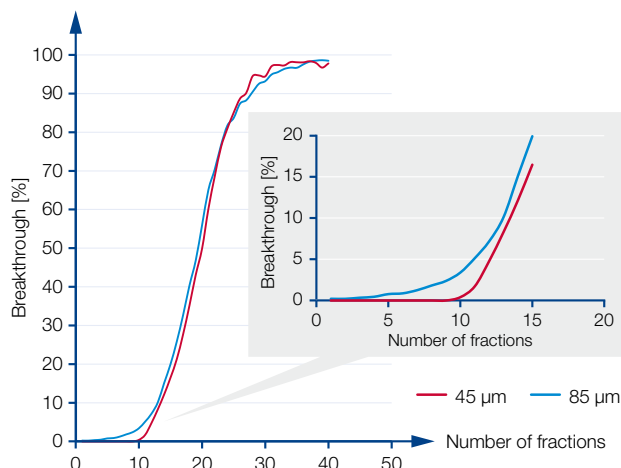



The CHROMABOND® HR-*Xpert* concept for neutral, acidic and basic analytes

3 paths - 1 goal: cleaner samples

Depending on the character of the analytes HR-*Xpert* offers suitable adsorbents and optimal methods for sample preparation, cleaning and concentration.

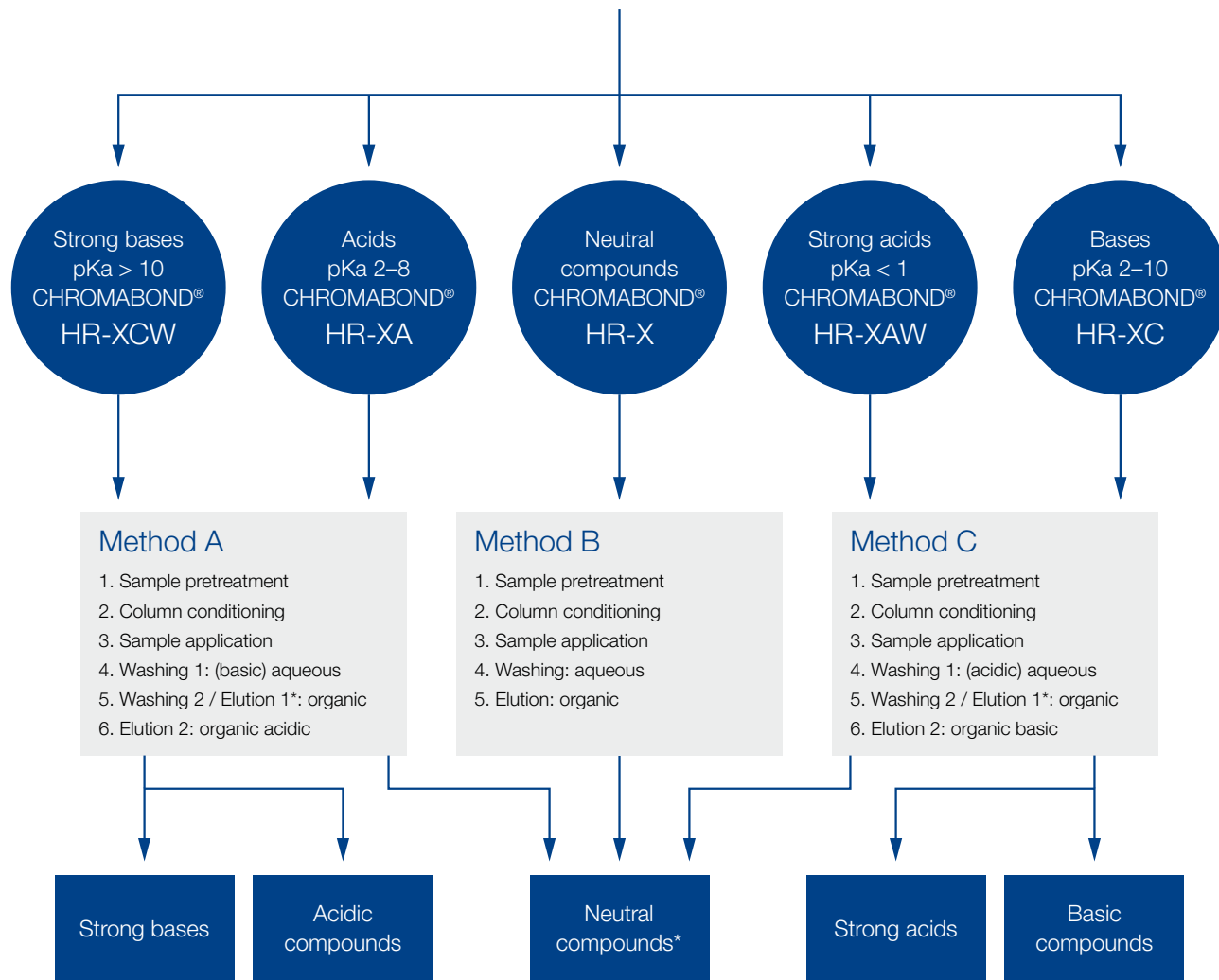

* Under organic washing and elution conditions the following compounds will be also eluted

HR-X: polar compounds such as organic acids and bases
HR-XC, HR-XCW: acidic components and impurities
HR-XA, HR-XAW: basic components and impurities



CHROMABOND® HR-X HR-X spherical, hydrophobic polystyrene-divinylbenzene adsorbent resin

★ Key features

- High-purity material with highest reproducibility and lowest blank values due to an optimized manufacturing process
- Excellent recovery rates especially for the enrichment of pharmaceuticals and active ingredients due to the spherical structure of the particles, very homogeneous surface and optimized pore structure

🔧 Technical characteristics

- Hydrophobic polystyrene-divinylbenzene copolymer, pH stability 1–14
- Spherical particles, size 45 µm and 85 µm (standard), pore size 55–60 Å, very high surface 1000 m²/g, capacity 390 mg/g (caffeine in water)

✓ Recommended application

- Pharmaceuticals / active ingredients from tablets, creams and water / waste water
- Drugs and pharmaceuticals from urine, blood, serum and plasma
- Trace analysis of pesticides, herbicides, phenols, PAHs and PCBs from water

Drugs from water

MN Appl. No. 304240

Column type:
CHROMABOND® HR-X, 3 mL, 200 mg
REF 730931

Sample: 1 µg/mL each in water

Column conditioning: 5 mL methanol, 5 mL dist. water

Sample application:

slowly aspirate 500 mL water (pH 3) through the column

Column washing: 5 mL water

Elution: after drying 3 x 2 mL acetonitrile

Further analysis: HPLC on NUCLEODUR® C₁₈ Gravity, 5 µm; see MN Appl. No. 121690

Recovery rates [%]

Compound	HR-X	Strata™ X
Ketoprofen	98	92
Ibuprofen	91	93
Pentobarbital	99	95
Meclofenamic acid	92	93
Protriptyline	63	45
Nortriptyline	53	39

Pesticides from water

MN Appl. No. 304250 / 304260

Column type:
CHROMABOND® HR-X, 3 mL, 200 mg
REF 730931

Sample pretreatment: samples are spiked with 500 ng of each pesticide in 1000 mL water, adjusted to pH 2 with HCl or pH 7

Column conditioning:

10 mL methanol, 10 mL dist. water

Sample application:

slowly pass 1000 mL spiked water sample through the column with the aid of a tubing adapter (REF 730243)

Elution: after drying 5 mL methanol – THF (1:1, v/v)

Further analysis: HPLC

Recovery rates [%]

Compound	HR-X pH 2	Compound	HR-X pH 7
Metamitron	86	Desisopropylatrazine	90
Quinmerac	90	2,4-Dichlorobenzamide	95
Chloridazon	93	Desethylatrazine	89
Picloram	83	Hexazinone	95
Metribuzin	84	Bromacil	103
Cyanazine	83	Simazine	91
Metabenzthiazuron	94	Desethylterbuthylazine	89
Chlortoluron	91	Atrazine	88
Isoproturon	89	Metalaxyl	97
Diuron	91	Metazachlor	93
Dimethenamid-P	89	Propazine	88
Linuron	94	Terbuthylazine	86
Epoxyconazole	85	Metolachlor	97
Penconazole	90		
Alachlor	93		
Propiconazole-1	89		
Flufenacet	91		
Diflufenicam	58		
Triallate	42		

For further applications on CHROMABOND® phases visit our online application database at www.mn-net.com/apps



Standard protocol for CHROMABOND® HR-X

MN Appl. No. 304310



Column type:
CHROMABOND® HR-X, 3 mL, 200 mg
REF 730931

Sample pretreatment: if necessary, adjust pH value

Column conditioning: 5 mL methanol

Equilibration: 5 mL water

Sample application: slowly aspirate the sample through the column

Column washing: 5 mL water – methanol (95:5, v/v)

Elution: after drying 3 x 2 mL methanol

Further analysis: if necessary, evaporate and redissolve in a suitable solvent; HPLC or GC

Highest reproducibility Barbiturates from serum

MN Appl. No. 304290



Column type:
CHROMABOND® HR-X, 3 mL, 200 mg
REF 730931

Sample: 100 ng/mL each in serum

Column conditioning: 5 mL methanol, 5 mL dist. water

Sample application: 1 mL spiked serum

Column washing: 5 mL water

Elution: after drying 3 x 2 mL methanol

Further analysis: HPLC on NUCLEODUR® 100-5 C₁₈ ec, see MN Appl. No. 117820

- Within each batch
- From batch to batch

Compounds:

- A phenobarbital
- B pentobarbital
- C hexobarbital

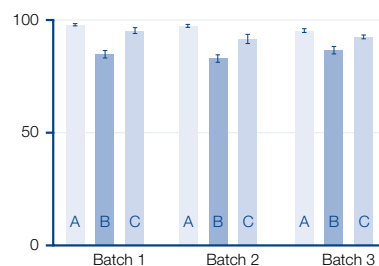

Ordering information

Volume	Adsorbent weight →				500 mg	1 g	Pack of
	30 mg	60 mg	100 mg	200 mg			
CHROMABOND® HR-X polypropylene columns (85 µm)							
1 mL	730934		730935				30
3 mL		730936		730931	730937		30
6 mL				730938	730939		30
15 mL					730940	730941	20
CHROMABOND® HR-X polypropylene columns (85 µm) · BIGpacks							
3 mL				730931.250			250
6 mL				730938.250	730939.250		250
CHROMABOND® HR-X polypropylene columns (45 µm)							
1 mL	730934P45		730935P45				30
3 mL		730936P45		730931P45			30
CHROMABOND® LV-HR-X (85 µm)							
15 mL	732130	732131		732132			30
CHROMABOND® MULTI 96 HR-X							
	96 x 10 mg (45 µm)	96 x 25 mg (45 µm)	96 x 50 mg (85 µm)	96 x 100 mg (85 µm)			Pack of
	738530.010M	738530.025M	738530.050M	738530.100M			1

Glass columns, LV columns and MULTI 96 on request.

For further applications on CHROMABOND® phases visit our online application database at www.mn-net.com/apps



CHROMABOND® HR-XC strong cation exchanger

★ Key features

- High purity material, highest reproducibility and lowest blank values due to an optimized production process
- Outstanding recovery rates especially for the enrichment of basic analytes

🔧 Technical characteristics

- Strong acidic benzenesulfonic acid cation exchanger, exchange capacity 1.0 meq/g, base material polystyrene-divinylbenzene copolymer, pH stability 1–14
- Spherical particles, size 45 µm and 85 µm (standard), pore size 65–75 Å, very large specific surface 800 m²/g, pore volume 1.4 cm³/g, RP capacity 300 mg/g (caffeine in water)

✓ Recommended application

- Basic active ingredients from heavily matrix-contaminated samples like, e.g., urine, plasma, serum
- Fungicides from food
- Basic analytes like, e.g., amines
- Bases with pKa 2–10

Standard protocol for CHROMABOND® HR-XC

MN Appl. No. 304790

 **Column type:**
CHROMABOND® HR-XC, 3 mL, 200 mg
REF 730952

Sample pretreatment: adjust pH value if necessary

Column conditioning: 5 mL methanol

Equilibration: 5 mL water

Sample application: slowly aspirate sample through the column

Column washing 1: 2 mL 0.1 mol/L HCl in Wasser

Column washing 2 / Elution 1: 2 mL methanol (neutral and acidic compounds); if necessary, further washing steps

Elution 2: after drying 5 mL methanol – 5 % NH₃ (basic compounds)

Further analysis: if necessary, evaporate and redissolve in a suitable solvent; HPLC or GC

Fractionation of acidic, neutral and basic analytes from serum

MN Appl. No. 304780

 **Column type:**
CHROMABOND® HR-XC, 3 mL, 200 mg
REF 730952

Sample: 1 mL spiked matrix, acidified with 200 µL 2 % H₃PO₄

Column conditioning: 5 mL methanol, then 5 mL water

Sample application: slowly aspirate sample through the column

Column washing: 2 mL 0.1 mol/L HCl

Elution: 2.5 mL methanol (fraction A: neutral and acidic analytes); then 5 mL methanol – NH₃ 90:10, v/v (fraction B: basic analytes)

Further analysis:

for fraction A:

HPLC, e.g., on NUCLEODUR® C₁₈ Gravity, see MN Appl. No. 122230;

for fraction B:

HPLC on NUCLEODUR® C₈ Gravity, see MN Appl. No. 118520

Recovery rates [%]

Compound	Fraction A: neutral and acidic analytes		Fraction B: basic analytes			
	HR-XC		HR-XC	Oasis® MCX	Strata™ X-C	
Suprofen	108		Doxepin	101	68	82
Naproxen	85		Imipramine	95	71	85
Tolmetin	73		Amitriptyline	94	72	78
Phenobarbital	108		Trimipramine	92	70	81
Indomethacin	33					
Hexobarbital	80					

Ordering information

Volume	Adsorbent weight →						Pack of
	30 mg	60 mg	100 mg	150 mg	200 mg	500 mg	
CHROMABOND® HR-XC polypropylene columns (85 µm)							
1 mL	730969		730049				30
3 mL		730956			730952	730953	30
6 mL				730957		730955	30
CHROMABOND® HR-XC polypropylene columns (45 µm)							
1 mL	730969P45		730049P45				30
3 mL		730956P45			730952P45		30
CHROMAFIX® HR-XC cartridges (85 µm)							
Size →	S		M		L		
Adsorbent weight →	155 mg		240 mg		500 mg		Pack of
	731755		731756		731757		50

Glass columns, LV columns and MULTI 96 on request.



CHROMABOND® HR-XA strong anion exchanger

★ Key features

- High purity material with highest reproducibility and lowest blank values due to an optimized production process
- Outstanding recovery rates especially for the enrichment of acidic analytes

🔧 Technical characteristics

- Strong basic quaternary ammonium anion exchanger, exchange capacity 0.25 meq/g, pKa ~ 18, base material polystyrene-divinylbenzene copolymer, pH stability 1–14
- Spherical particles, size 45 µm and 85 µm (standard), pore size 55–65 Å, very large specific surface 850 m²/g, pore volume 1.4 cm³/g, RP capacity 350 mg/g (caffeine in water)

✓ Recommended application

- Acidic active ingredients from heavily matrix-contaminated samples like, e.g., urine, plasma, serum
- Phenolic acids
- Acidic herbicides
- Weak / medium-strength acids with pKa 2–8

Standard protocol for CHROMABOND® HR-XA

MN Appl. No. 304970

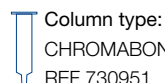

Column type:

CHROMABOND® HR-XA, 3 mL, 200 mg

REF 730951

Sample pretreatment:

individual sample preparation with reference to analytes and matrix

Column conditioning: 5 mL methanol

Equilibration: 5 mL water

Sample application: slowly aspirate sample through the column

Column washing 1: 2 mL 0.1 mol/L NaOH in water

Column washing 2 / Elution 1: 2 mL methanol (neutral and basic compounds), if necessary, further washing steps

Elution 2: after drying 5 mL methanol – 1 to 10 % formic acid (acidic compounds)

Further analysis: if necessary, evaporate and redissolve in a suitable solvent; HPLC or GC MN Appl. No. 304970

Ordering information

Volume	Adsorbent weight →			150 mg	200 mg	500 mg	Pack of
	30 mg	60 mg	100 mg				
CHROMABOND® HR-XA polypropylene columns (85 µm)							
1 mL	730968		730727				30
3 mL		730950			730951	730954	30
6 mL				730958		730966	30
CHROMABOND® HR-XA polypropylene columns (45 µm)							
1 mL	730968P45		730727P45				30
3 mL		730950P45			730951P45		30
CHROMAFIX® HR-XA cartridges (85 µm)							
Size →	S		M		L		
Adsorbent weight →	155 mg		240 mg		500 mg		Pack of
	731768		731769		731770		50

Glass columns, LV columns and MULTI 96 on request.

For further applications on CHROMABOND® phases visit our online application database at www.mn-net.com/apps



CHROMABOND® HR-XCW weak cation exchanger

★ Key features

- High purity material, highest reproducibility and lowest blank values due to an optimized production process
- Outstanding recovery rates especially for enrichment of strongly basic analytes

🔧 Technical characteristics

- Weak acidic carboxylic acid cation exchanger, exchange capacity >0.7 meq/g, pKa ~ 5, base material spherical PS/DVB copolymer, pH stability 1–14
- Spherical particles, size 45 µm and 85 µm (standard), pore size 50–60 Å very large specific surface 850 m²/g, pore volume 1.2–1.4 cm³/g, RP capacity 350 mg/g (caffeine in water)

✓ Recommended application

- Basic compounds like quaternary amines
- Active ingredients from heavily matrix-contaminated samples like, e.g., urine, plasma, serum
- Strong bases with pKa > 10

Standard protocol for CHROMABOND® HR-XCW

MN Appl. No. 305300

 Column type:
CHROMABOND® HR-XCW, 3 mL, 200 mg
REF 730739

Sample pretreatment:
individual sample preparation with reference to analytes and matrix
Column conditioning: 5 mL methanol, 5 mL water

Sample application:
slowly aspirate sample through the column



Column washing 1: 2 mL acidified water

Column washing 2 / Elution 1: 2 mL methanol (neutral and acidic compounds), further washing steps if necessary

Elution 2: after drying 2 x 2 mL methanol – 1 to 5 % formic acid (strongly basic compounds)

Further analysis: if necessary, evaporate and redissolve in a suitable solvent; HPLC or GC

Ordering information

	Volume	Adsorbent weight →					Pack of	
		30 mg	60 mg	100 mg	150 mg	200 mg		500 mg
	CHROMABOND® HR-XCW polypropylene columns (85 µm)							
	1 mL	730731		730733			30	
	3 mL		730735			730739	730741	30
	6 mL				730737		730743	30
	CHROMABOND® HR-XCW polypropylene columns (45 µm)							
	1 mL	730731P45		730733P45			30	
	3 mL		730735P45			730739P45	30	
	Size →	S		M		L		
Adsorbent weight →		155 mg		240 mg		500 mg	Pack of	
CHROMAFIX® HR-XCW cartridges (85 µm)								
		731774		731775		731776	50	

Glass columns, LV columns and MULTI 96 on request.

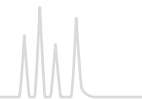

CHROMABOND® HR-XAW weak anion exchanger

★ Key features

- High purity material with highest reproducibility and lowest blank values due to an optimized production process
- Outstanding recovery rates especially for enrichment of acidic analytes

🔧 Technical characteristics

- Weak basic secondary and tertiary ammonium anion exchanger, exchange capacity >0.5 meq/g, pKa ~ 6, base material spherical PS/DVB copolymer, pH stability 1–14
- Spherical particles, size 45 µm and 85 µm (standard), pore size 55–65 Å very large specific surface 850 m²/g, pore volume 1.2–1.4 cm³/g, RP capacity 350 mg/g (caffeine in water)

✓ Recommended application

- Perfluorinated surfactants
- Acidic compounds like sulfonates
- Active ingredients from heavily matrix-contaminated samples like, e.g., urine, plasma, serum
- Strong acids with pKa < 1

Standard protocol for CHROMABOND® HR-XAW

MN Appl. No. 305200

 **Column type:**
CHROMABOND® HR-XAW, 3 mL, 200 mg
REF 730748

Sample pretreatment:
individual sample preparation with reference to analytes and matrix
Column conditioning: 5 mL methanol
Equilibration: 5 mL water

Sample application:
slowly aspirate sample through the column

Column washing 1: 25 mmol/L ammonium acetate
Column washing 2 / Elution 1: 2 mL methanol (neutral and basic compounds), if necessary, further washing steps

Elution 2: after drying 2 x 2 mL methanol – 1 to 5 % ammonia (strongly acidic compounds)

Further analysis: if necessary, evaporate and redissolve in a suitable solvent; HPLC or GC

Analysis of perfluorinated surfactants from water

MN Appl. No. 305140

Application in accordance with DIN 38407-42

 **Column type:**
CHROMABOND® HR-XAW, 3 mL, 60 mg
REF 730747

Sample: 500 mL water, spiked with 1 mL standard solution (20 µg/L of each compound)

Column conditioning:
2 mL methanol + 5 % ammonia, then 2 mL methanol, finally 2 mL water

Sample application:
slowly aspirate sample through the column

Column washing: 2 mL water, then 2 mL acetone – acetonitrile – formic acid (50:50:1, v/v/v), finally 2 mL methanol



Elution: 2 mL methanol with 5 % ammonia

Further analysis: evaporate to dryness in a stream of nitrogen under slight heating, and redissolve in a suitable solvent for HPLC

Recovery rates [%]

Compound	Recovery
Perfluoropropionic acid (PFPrA)	103
Perfluoropentanoic acid (PFPeA)	94
Perfluorohexanoic acid (PFHxA)	94
Perfluorooctanoic acid (PFOA)	95
Perfluorooctane sulfonate K salt (PFOS)	81
Perfluorododecanoic acid (PFDoDA)	82

Ordering information

Volume	Adsorbent weight →			150 mg	200 mg	500 mg	Pack of
	30 mg	60 mg	100 mg				
 CHROMABOND® HR-XAW polypropylene columns (85 µm)							
1 mL	730728		730729				30
3 mL		730747			730748	730744	30
6 mL				730749		730745	30
CHROMABOND® HR-XAW polypropylene columns (45 µm)							
1 mL	730728P45		730729P45				30
3 mL		730747P45			730748P45		30
 CHROMAFIX® HR-XAW cartridges (85 µm)							
Size →	S		M		L		
Adsorbent weight →	155 mg		240 mg		500 mg		Pack of
	731771		731772		731773		50

Glass columns, LV columns and MULTI 96 on request.



CHROMABOND® Easy polar, bifunctionally modified polystyrene-divinylbenzene copolymer

★ Key features

The Easy effect:

- Without preconditioning
- Due to bifunctional modification much more hydrophilic than conventional polystyrene-divinylbenzene polymers
- Easily wettable with water

🔧 Technical characteristics

- Polar modified polystyrene-divinylbenzene copolymer with a weak anion exchanger, specific surface 650–700 m²/g, particle size 80 μm, pore size 50 Å, pH stability 1–14

✓ Recommended application

- Polar herbicides and pesticides from water (acidic, neutral, basic), polar phenols from water, polyaromatic compounds, polychlorinated biphenyls
- Drug analysis from urine, blood, serum, plasma
- Pharmaceuticals and active ingredients from tablets, creams

Recovery of pesticides

MN Appl. No. 303220

Private communication Mr. Kühn, GUB, Waldshut Tiengen, Germany

 **Column type:**
CHROMABOND® Easy, 3 mL, 200 mg
REF 730754

Column conditioning:
1 mL water, 3 mL methanol, 1 mL water

Sample application:
aspirate the sample through the column

Elution:
3 x 1 mL acetone

Further analysis: HPLC with NUCLEOSIL® 120-5 C₁₈

Recovery rates [%]

Compound	Recovery	Compound	Recovery
Desisopropylatrazine	90	Metalaxyl	96
2,6-Dichlorobenzamide	93	Isoproturon	94
Desethylatrazine	93	Diuron	94
Hexazinone	69	Metazachlor	97
Terbacil	65	Propazine	95
Simazine	81	Terbutylazine	93
Cyanazine	93	Linuron	96
Desethylterbutylazine	91	Metolachlor	97
Methabenzthiazuron	94	Triallate	61
Chlortoluron	91	Standard	64
Atrazine	92		

Ordering information

Volume	Adsorbent weight →			200 mg	500 mg	1 g	Pack of
	30 mg	60 mg	100 mg				
CHROMABOND® Easy polypropylene columns							
1 mL	730751		730752				30
3 mL		730753		730754	730759		30
6 mL				730755	730756		30
15 mL					730757	730758	20
CHROMABOND® Easy polypropylene columns · BIGpacks							
3 mL				730754.250			250
6 mL				730755.250			250
CHROMABOND® LV-Easy							
15 mL				732472			30
CHROMABOND® MULTI 96 Easy							
	96 x 25 mg		96 x 50 mg		96 x 100 mg		Pack of
	738520.025M		738520.050M		738520.100M		1
CHROMABOND® Easy adsorbent							
					730661		20 g

For further applications on CHROMABOND® phases visit our online application database at www.mn-net.com/apps



CHROMABOND® HR-P polystyrene-divinylbenzene adsorbent resin

★ Key features

- Very high binding capacity, up to 30 % of adsorbent weight (for comparison: silica adsorbents about 3 %)

🔧 Technical characteristics

- Highly porous polystyrene-divinylbenzene copolymer, specific surface 1200 m²/g, particle size 50–100 µm

✓ Recommended application

- Aromatic compounds, phenols from water, nitroaromatics from water, pesticides from water, PAHs from oil

Aromatic amines from water samples

MN Appl. No. 301810

Private communication M. Leß, T.C. Schmidt, Department of Chemistry, University Marburg, 1997

Compounds investigated: aromatic amines

Column type:

CHROMABOND® HR-P, 3 mL, 200 mg
REF 730108

Sample pretreatment: adjust to pH 9 using 10 mol/L NaOH

Column conditioning: 2 mL each of methanol, acetonitrile and 10⁻⁵ mol/L aqueous sodium hydroxide solution





Sample application: aspirate sample through the column with about 10 mL/min

Column washing: wash with 2 mL dist. water, dry 5 min under vacuum

Elution: 3 x 1 mL methanol – acetonitrile (1:1, v/v)

For recovery rates of numerous aromatic amines please see application 301810 at www.mn-net.com/apps

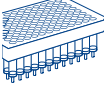
Ordering information

	Volume	Adsorbent weight →			Pack of	
		100 mg	200 mg	500 mg		1 g
	CHROMABOND® HR-P polypropylene columns					
	1 mL	730280			30	
	3 mL		730108	730117	30	
	6 mL		730119	730111	730118	30
	CHROMABOND® HR-P polypropylene columns · BIGpack					
	3 mL		730108.250		250	
	CHROMABOND® HR-P glass columns					
	3 mL		730108G		30	
	6 mL			730111G	730118G	30
	CHROMABOND® LV-HR-P					
	15 mL		732108		30	
	Size →		S	M	L	Pack of
	Adsorbent weight →		200 mg	330 mg	680 mg	
	CHROMAFIX® HR-P cartridges					
			731839	731840	731841	50
	CHROMABOND® MULTI 96 HR-P					
					96 x 100 mg	Pack of
	CHROMABOND® HR-P adsorbent					
					738111.100M	1
				730615		20 g

For further applications on CHROMABOND® phases visit our online application database at www.mn-net.com/apps



CHROMABOND® PS-RP / PS-OH⁻ / PS-H⁺ / PS-Mix / PS-Ag⁺ / PS-Ba²⁺ phases for RP and ion chromatography

★ Key features

- Very low degree of swelling, thus very well suited for chromatography, reliable function over the whole pH range from 0–14

🔧 Technical characteristics

- Base material high purity polystyrene-divinylbenzene copolymers (PS/DVB), pore size 100 Å, particle size 100 µm
- Different modifications for different applications from the elimination of nonpolar compounds up to the removal of specific polar components

✓ Recommended application

- Removal of interfering compounds
- Improves chromatographic separation, if the interfering components overlap with the analyte in the chromatogram
- Improves lifetime of the chromatographic column, since interfering components can irreversibly block the column packing
- Enrichment of the analytes

Properties of the individual modifications

PS-RP	hydrophobic PS/DVB copolymer	removal of organic interfering components from water
PS-OH ⁻	strong PS/DVB anion exchanger, OH ⁻ form capacity 0.6 meq/g	removal or concentration of anions from water increasing the pH value in acidic samples
PS-H ⁺	strong PS/DVB cation exchanger, H ⁺ form capacity 2.9 meq/g	removal or concentration of cations from water decreasing the pH value of basic samples
PS-Mix	mixture of PS-OH ⁻ and PS-H ⁺	desalting of water
PS-Ag ⁺	strong PS/DVB cation exchanger, Ag ⁺ form	removal of halide ions from water
PS-Ba ²⁺	strong PS/DVB cation exchanger, Ba ²⁺ form	removal of sulfate ions from water

Removal of halides from aqueous samples shown for the trace analysis of nitrate besides an excess of chloride or bromide

MN Appl. No. 301930 / 302750

Compounds investigated:

20 ppm nitrate besides 2500 ppm chloride or 500 ppm bromide

Column type:

CHROMAFIX® PS-Ag⁺ (M) 0.8 mL, Ø 480 mg
REF 731865

Column conditioning: 1 mL dist. water

Sample application and Elution:

apply 4 x 1 mL sample fractions to the cartridge, discard 1st mL, collect 2nd, 3rd and 4th mL separately

Further analysis: HPLC with column 250 x 4 mm NUCLEOSIL® Anion II; eluent 2 mmol/L potassium hydrogen phthalate pH 6, 2 mL/min; detection: indirect UV, 280 nm (see applications 110440 and 110450 at www.mn-net.com/apps)

Ordering information

Phases	Adsorbent weight → 3 mL / 200 mg	3 mL / 500 mg	6mL / 500 mg	6 mL / 900 mg	Pack of		
CHROMABOND® PS polypropylene columns							
PS-RP	730765	730692	730693		30		
PS-OH ⁻	730396	730344	730378		30		
PS-H ⁺	730690	730376	730377		30		
PS-Mix		730394		730310	30		
CHROMAFIX® PS cartridges							
Phases	Size S	Adsorbent weight	Size M	Adsorbent weight	Size L	Adsorbent weight	Pack of
PS-RP	731877	200 mg	731875	320 mg			50
PS-OH ⁻	731868	200 mg	731860	380 mg	731862	800 mg	50
PS-H ⁺	731867	230 mg	731861	430 mg	731863	900 mg	50
PS-Mix	731909	230 mg					50
PS-Ag ⁺	731866	240 mg	731865	480 mg			50
PS-Ba ²⁺	731871	280 mg	731870	550 mg			50



CHROMABOND[®] reversed phases



CHROMABOND[®] C₁₈ ec / C₁₈ ec f (f = fast flow) octadecyl silica, endcapped

★ Key features

- Very nonpolar, hydrophobic interactions with a wide variety of organic compounds
- Advantageous for the clean-up of samples with large structural variations (polarity differences)

🔧 Technical characteristics

- Base material silica, pore size 60 Å, particle size 45 µm for C₁₈ ec, 100 µm for C₁₈ ec f (for fast flow), specific surface 500 m²/g, pH stability 2–8
- Octadecyl phases, endcapped, carbon content 14 %

✓ Recommended application

- Nonpolar compounds
 aflatoxins, amphetamines, antibiotics, antiepileptics, barbiturates, caffeine, drugs, preservatives, fatty acids, nicotine, PAHs, pesticides, PCBs, heavy metals, vitamins
- Very well suited for desalting of samples
- C₁₈ ec f for viscous samples

Ordering information

	Volume	Adsorbent weight →						Pack of	
		100 mg	200 mg	500 mg	1 g	2 g	5 g	10 g	
	CHROMABOND[®] C₁₈ ec polypropylene columns								
	1 mL	730011							100
	3 mL		730012	730013					50
	6 mL			730014	730015	730141			30
	15 mL					730404			20
	45 mL							730405	20
	70 mL							730259	10
	CHROMABOND[®] C₁₈ ec polypropylene columns · BIGpacks								
	3 mL			730013.250					250
	6 mL			730014.250	730015.250				250
	CHROMABOND[®] C₁₈ ec glass columns								
	3 mL		730012G	730013G					50
	6 mL			730014G	730015G				30
	CHROMABOND[®] LV-C₁₈ ec								
	15 mL		732012	732013					30
	Size →		S	M	L				
	Adsorbent weight →		270 mg	530 mg	950 mg	Pack of			
	CHROMAFIX[®] C₁₈ ec cartridges								
			731804	731805	731806	50			
			96 x 25 mg	96 x 50 mg	96 x 100 mg	Pack of			
	CHROMABOND[®] MULTI 96 C₁₈ ec								
			738011.025M	738011.050M	738011.100M	1			
	CHROMABOND[®] C₁₈ ec adsorbent								
								730611	100 g
	Adsorbent weight →		200 mg	500 mg	1 g	2 g	5 g	10 g	Pack of
	Volume		100 mg						
	CHROMABOND[®] C₁₈ ec f polypropylene columns (fast flow)								
	3 mL		730269	730018					50
	6 mL			730016	730010				30
	CHROMABOND[®] C₁₈ ec f adsorbent (fast flow)								
								730613	100 g



CHROMABOND® C₁₈/C₁₈ f (f = fast flow) octadecyl silica

★ Key features

- Similar to C₁₈ ec, however possesses more free silanols (SiOH), which allow secondary interactions with polar groups of the analytes

🔧 Technical characteristics

- Base material silica, pore size 60 Å, particle size 45 µm for C₁₈, 100 µm for C₁₈ f (for fast flow), specific surface 500 m²/g, pH stability 2–8
- Octadecyl phases, not endcapped, carbon content 14 %

✓ Recommended application

- Nonpolar compounds, pesticides
- C₁₈ f for viscous samples

Ordering information

Volume	Adsorbent weight →							Pack of
	100 mg	200 mg	500 mg	1 g	2 g	5 g	10 g	
CHROMABOND® C₁₈ polypropylene columns								
1 mL	730001							100
3 mL		730002	730003					50
6 mL			730004	730005	730130			30
15 mL					730028			20
45 mL						730400		20
70 mL							730261	10
CHROMABOND® C₁₈ polypropylene columns · BIGpacks								
3 mL			730003.250					250
6 mL			730004.250	730005.250				250
CHROMABOND® C₁₈ glass columns								
3 mL			730003G					50
6 mL			730004G	730005G				30
CHROMABOND® LV-C₁₈								
15 mL		732002						30
CHROMAFIX® C₁₈ cartridges								
Size →		S	M	L				Pack of
Adsorbent weight →		240 mg	480 mg	950 mg				
		731801	731802	731803				50
		96 x 25 mg		96 x 100 mg				Pack of
CHROMABOND® MULTI 96 C₁₈								
		738001.025M		738001.100M				1
CHROMABOND® C₁₈ adsorbent								
						730602		100 g
CHROMABOND® C₁₈ f polypropylene columns (fast flow)								
3 mL		730402	730008					50
6 mL			730403	730009				30
CHROMABOND® C₁₈ f adsorbent (fast flow)								
						730612		100 g

For further applications on CHROMABOND® phases visit our online application database at www.mn-net.com/apps



CHROMABOND® C₁₈ Hydra octadecyl silica for polar analytes

★ Key features

- Special octadecyl phase for polar analytes, not endcapped, carbon content 15 %

🔧 Technical characteristics

- Base material silica, pore size 60 Å, particle size 45 µm, specific surface 500 m²/g, pH stability 2–8

✓ Recommended application

- Polar compounds like pesticides and their polar degradation products, phenols, phenoxy-carboxylic acids

Pesticides from water

MN Appl. No. 302060

Compounds investigated: triazines and carboxylic amides

📏 Column type:

CHROMABOND® C₁₈ Hydra, 6 mL, 2 g
REF 730301

Sample pretreatment: adjust 1000 mL water to pH 7–8 with diluted NH₃ and add 100 µL of the internal standards (1 µg/L).

Column conditioning: 2 x 5 mL methanol, then 2 x 5 mL dist. water





Sample application: force or aspirate the sample through the column. Then dry for 2 h with 2 bar N₂.

Elution: slowly aspirate 10 mL methanol through the column. Evaporate the eluate to dryness in a tapered flask with a rotation evaporator at 30 °C and store in a refrigerator for ~15 min. Redissolve the residue in 200 µL cold, fresh *n*-hexane and transfer the solution to a conic HPLC vial (e.g., REF 702891). Store the solution in a refrigerator until chromatography.

Recovery rates: between 95 and 100 %

Further analysis: GC with OPTIMA® δ-3 or OPTIMA® δ-6 (e.g., application 250420) or HPLC in accordance with EN ISO 11369: 1997 on NUCLEOSIL® 120-3 C₁₈ (application 110880)

Ordering information

Volume	Adsorbent weight →							Pack of
	50 mg	100 mg	200 mg	500 mg	1 g	2 g	3 g	
 CHROMABOND® C₁₈ Hydra polypropylene columns								
1 mL	730294	730295						100
3 mL			730296	730297	730298			50
6 mL				730299	730300	730301	730302	30
CHROMABOND® C₁₈ Hydra glass columns								
3 mL			730296G	730297G	730298G			50
6 mL				730299G	730300G			30
 CHROMABOND® LV-C₁₈ Hydra								
15 mL			732295					30
 CHROMAFIX® C₁₈ Hydra cartridges								
Size →		S	M	L				
Adsorbent weight →		270 mg	530 mg	950 mg	Pack of			
		731730	731731	731732	50			
 CHROMABOND® MULTI 96 C₁₈ Hydra								
				96 x 100 mg	Pack of			
				738294.100M	1			
 CHROMABOND® C₁₈ adsorbent								
							730628	100 g

For further applications on CHROMABOND® phases visit our online application database at www.mn-net.com/apps



CHROMABOND® C₈ octyl silica

★ Key features

- Similar to C₁₈, however slightly more polar
- Secondary interactions with polar compounds are more pronounced due to shorter alkyl chains

🔧 Technical characteristics

- Base material silica, pore size 60 Å, particle size 45 µm, specific surface 500 m²/g, pH stability 2–8
- Octyl phase, not endcapped, carbon content 8 %

✓ Recommended application

- Pesticides, PCBs

Ordering information

	Volume	Adsorbent weight → 100 mg	200 mg	500 mg	1 g	Pack of
	CHROMABOND® C₈ polypropylene columns					
	1 mL	730021				100
	3 mL		730022	730023		50
	6 mL			730024	730134	30
	CHROMABOND® C₈ glass columns					
	6 mL			730024G		30
	CHROMABOND® LV-C₈					
	15 mL			732023		30
		Size →	M			
		Adsorbent weight →	520 mg			Pack of
	CHROMAFIX® C₈ cartridges					
			731808			50
					96 x 100 mg	Pack of
	CHROMABOND® MULTI 96 C₈					
					738021.100M	1
	CHROMABOND® C₈ adsorbent					
					730601	100 g



CHROMABOND[®] C₄ butyl silica

★ Key features

- Slightly more polar than C₁₈ or C₈, due to shorter alkyl chains the silica surface is not completely shielded

🔧 Technical characteristics

- Base material silica, pore size 60 Å, particle size 45 µm, specific surface 500 m²/g, pH stability 2–8
- Butyl phase, not endcapped, carbon content 7 %

✓ Recommended application

- Compounds, which are too strongly retained on C₁₈ or C₈ e.g., analgetics from blood

Ordering information

	Volume	Adsorbent weight →	100 mg	500 mg	Pack of
	CHROMABOND[®] C₄ polypropylene columns				
	1 mL		730225		100
	3 mL			730227	50
		Size →	S	M	
		Adsorbent weight →	220 mg	440 mg	Pack of
	CHROMAFIX[®] C₄ cartridges				
			731740	731741	50
	CHROMABOND[®] C₄ adsorbent				
				730651	100 g

Glass columns, LV columns and MULTI 96 on request.

CHROMABOND[®] C₂ dimethyl silica

★ Key features

- Similar to C₄

🔧 Technical characteristics

- Base material silica, pore size 60 Å, particle size 45 µm, specific surface 500 m²/g, pH stability 2–8
- Dimethyl phase, not endcapped, carbon content 4 %

✓ Recommended application

- e.g., antiepileptics from plasma

Ordering information

	Volume	Adsorbent weight →	100 mg	500 mg	1 g	Pack of
	CHROMABOND[®] C₂ polypropylene columns					
	1 mL		730169			100
	3 mL			730221		50
	6 mL			730409	730410	30
	CHROMABOND[®] C₂ adsorbent					
					730652	100 g

Glass columns, LV columns, CHROMAFIX[®] cartridges and MULTI 96 on request.



CHROMABOND® C₆H₁₁ ec cyclohexyl silica, endcapped

★ Key features

- Alternative phase for the midpolar range

🔧 Technical characteristics

- Base material silica, pore size 60 Å, particle size 45 µm, specific surface 500 m²/g, pH stability 2–8
- Cyclohexyl phase, endcapped, carbon content 9 %

✓ Recommended application

- Phenols from water
- Chloroanilines from waste water
- Anthelmintics from tissue

Comparison of different phases for phenol analysis

MN Appl. No. 302150

Compounds investigated: phenol, 2,4-dinitrophenol, pentachlorophenol

Column types:

CHROMABOND® C₁₈, 6 mL, 2000 mg

REF 730130

CHROMABOND® C₆H₁₁ ec, 6 mL, 2000 mg

REF 730469

Column conditioning: 10 mL acetone, 10 mL methanol, and 10 mL dist. water (pH 2)

Sample application: aspirate the sample through the column.

Elution: 10 mL methanol

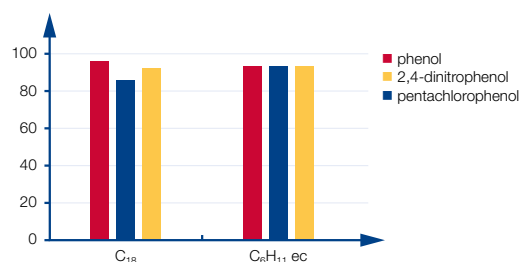

Ordering information

	Volume	Adsorbent weight →		Pack of
		500 mg	1 g	
	CHROMABOND® C₆H₁₁ ec polypropylene columns			
	3 mL	730442		50
	6 mL	730443	730444	30
	CHROMABOND® C₆H₁₁ ec adsorbent			
			730631	100 g

Glass columns, LV columns, CHROMAFIX® cartridges and MULTI 96 on request.



CHROMABOND[®] C₆H₅ phenyl silica

★ Key features

- Polarity similar to C₈
- In addition to hydrophobic interactions more selective adsorption is possible by π-π interactions due to the electron density of the phenyl ring.

🔧 Technical characteristics

- Base material silica, pore size 60 Å, particle size 45 μm, specific surface 500 m²/g, pH stability 2–8
- Phenyl phase, carbon content 8 %

✓ Recommended application

- Aflatoxins, caffeine, phenols

Flavor compounds from brandy

MN Appl. No. 300170

Compounds investigated: asarone, quinine, coumarin, quassin

📏 Column type:

CHROMABOND[®] C₆H₅, 6 mL, 1000 mg

REF 730412

Sample pretreatment: mix 10 mL sample with 90 mL water and 10 g sodium chloride and adjust to pH 7 with 0.1 mol/L sodium hydroxide solution

Column conditioning: 10 mL methanol, then 10 mL dist. water

Sample application: slowly force or aspirate the sample through the column

Column washing: 2.5 mL water, then 2.5 mL pentane

Elution: 1) 2 x 2.5 mL pentane – diethyl ether (7:3, v/v): asarone, coumarin
 2) 10 mL 1 mol/L basic methanol – diethyl ether (9:1, v/v): quinine
 3) 5 mL chloroform: quassin

Ordering information

	Volume	Adsorbent weight →			Pack of
		100 mg	200 mg	500 mg	
	CHROMABOND[®] C₆H₅ polypropylene columns				
	1 mL	730083			100
	3 mL		730411	730084	50
	CHROMABOND[®] C₆H₅ adsorbent				
				730606	100 g

Glass columns, LV columns, CHROMAFIX[®] cartridges and MULTI 96 on request.

For further applications on CHROMABOND[®] phases visit our online application database at www.mn-net.com/apps



CHROMABOND® SiOH unmodified silica

★ Key features

- Very polar
- Adsorbs humidity from air, for this reason it should be kept well closed and if necessary dried before use
- Due to its high affinity for polar compounds it should not be conditioned with polar (e.g., methanol) or water-containing solvents.

🔧 Technical characteristics

- Unmodified, weakly acidic silica, pore size 60 Å, particle size 45 µm, specific surface 500 m²/g, pH stability 2–8

✓ Recommended application

- Aflatoxins, chloramphenicol, pesticides, steroids, vitamins

Ordering information

Volume	Adsorbent weight →								Pack of
	100 mg	200 mg	500 mg	1 g	2 g	5 g	10 g	50 g	
CHROMABOND® SiOH polypropylene columns									
1 mL	730071								100
3 mL		730214	730073						50
6 mL			730070	730075	730107				30
15 mL					730217				20
45 mL						730406			20
70 mL							730072		10
150 mL								730473	10
CHROMABOND® SiOH polypropylene columns · BIGpacks									
3 mL			730073.250						250
6 mL				730075.250	730107.250				250
CHROMABOND® SiOH glass columns									
3 mL		730214G	730073G						50
6 mL			730070G	730075G	730107G				30
CHROMABOND® LV-SiOH									
15 mL		732072	732073						30
CHROMAFIX® SiOH cartridges									
	Size →	S	M	L					Pack of
	Adsorbent weight →	230 mg	420 mg	880 mg					
		731828	731829	731830					50
CHROMABOND® MULTI 96 SiOH									
					96 x 100 mg				Pack of
						738071.100M			1
CHROMABOND® SiOH adsorbent									
							730608		100 g

For further applications on CHROMABOND® phases visit our online application database at www.mn-net.com/apps



CHROMABOND® NH₂ aminopropyl silica

★ Key features

- Polar, weak anion exchanger

🔧 Technical characteristics

- Base material silica, pore size 60 Å, particle size 45 µm, specific surface 500 m²/g, pH stability 2–8
- Aminopropyl phase, carbon content 3.5 %

✓ Recommended application

- Trace elements, lipids

Metals: trace elements from water

MN Appl. No. 301910

Compounds investigated: Al, Be, Cu, Cr(VI), Mo(VI), V(V)

Column type:

CHROMABOND® NH₂, 3 mL, 500 mg

REF 730033

Sample pretreatment:

mix 100 mL water sample with 5 mL 0.001 % alizarinsulfonic acid solution and adjust to pH 5.5 with acetic acid or sodium acetate

Column conditioning: 2 column volumes 1 mol/L nitric acid, then 2 column volumes dist. water

Sample application: force or aspirate sample through the column with 3–4 mL/min

Column washing: 2 mL dist. water; dry column under vacuum for 4 min

Elution: 2 column volumes 2 mol/L nitric acid

Ordering information

	Volume	Adsorbent weight →				Pack of
		100 mg	200 mg	500 mg	1 g	
	CHROMABOND® NH₂ polypropylene columns					
	1 mL	730031				100
	3 mL		730413	730033		50
	6 mL			730180	730626	30
	CHROMABOND® NH₂ polypropylene columns · BIGpack					
	3 mL			730033.250		250
	CHROMABOND® NH₂ glass columns					
	3 mL			730033G		50
	6 mL			730180G	730626G	30
	CHROMABOND® LV-NH₂					
	15 mL			732033		30
	Size →		S			
	Adsorbent weight →		220 mg		Pack of	
	CHROMAFIX® NH₂ cartridges					
			731813			50
					96 x 100 mg	Pack of
	CHROMABOND® MULTI 96 NH₂				738031.100M	1
	CHROMABOND® NH₂ adsorbent					
				730603		100 g



CHROMABOND® OH (Diol) diol silica

★ Key features

- Polar, properties similar to SiOH



🔧 Technical characteristics

- Base material silica, pore size 60 Å, particle size 45 µm, specific surface 500 m²/g, pH stability 2–8
- Diol phase, carbon content 5.5 %

✓ Recommended application

- Antibiotics, prostaglandins

Ordering information

	Volume	Adsorbent weight →			Pack of
		100 mg	200 mg	500 mg	
	CHROMABOND® OH (Diol) polypropylene columns				
	1 mL	730051			100
	3 mL		730417	730053	50
	6 mL			730418	30
	CHROMABOND® OH (Diol) adsorbent				
				730605	100 g

Glass columns, LV columns, CHROMAFIX® cartridges and MULTI 96 on request.

CHROMABOND® CN cyanopropyl silica

★ Key features

- In addition to weak hydrophobic interactions selective interactions are possible due to the high electron density of the CN group.
- Polar to midpolar



🔧 Technical characteristics

- Base material silica, pore size 60 Å, particle size 45 µm, specific surface 500 m²/g, pH stability 2–8
- Cyanopropyl phase, carbon content 5.5 %

✓ Recommended application

- Cyclosporins, carbohydrates

Ordering information

	Volume	Adsorbent weight →			Pack of
		100 mg	200 mg	500 mg	
	CHROMABOND® CN polypropylene columns				
	1 mL	730061			100
	3 mL		730420	730063	50
	6 mL			730421	30
	CHROMABOND® CN adsorbent				
				730607	100 g

Glass columns, LV columns, CHROMAFIX® cartridges and MULTI 96 on request.

For further applications on CHROMABOND® phases visit our online application database at www.mn-net.com/apps



CHROMABOND® HILIC zwitterionic polar phase with ammonium sulfonic acid modification

Technical characteristics

- Basic material silica, pore size 60 Å, particle size 45 µm, specific surface 500 m²/g, pH stability 2–8

Recommended application

- Polar organic acids and bases, polar natural compounds, nucleosides, oligonucleotides, amino acids, peptides, water-soluble vitamins

Hydrophilic interaction liquid chromatography

A water-rich layer is formed on the surface of the adsorbent, which enables stronger interactions for polar than for nonpolar analytes. Thus polar analytes are more strongly retained than nonpolar compounds. This behavior is inverse (orthogonal) to RP materials like, e.g., CHROMABOND® C₁₈ ec.

In HILIC-HPLC (e.g., NUCLEODUR® HILIC) increase of the portion of water in the eluent results in reduction of the retention times – consequently enrichment in SPE is the more difficult, the higher the portion of water in the sample matrix. Elution of the analytes is achieved with water.

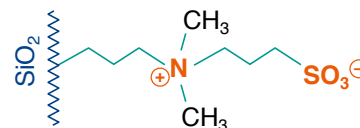

Standard protocol MN Appl. No. 305580

Column type:
CHROMABOND® HILIC, 3 mL, 500 mg
REF 730593

Sample pretreatment: A high part of acetonitrile in the sample is recommended. Aqueous samples must be diluted with acetonitrile (recommended: water – acetonitrile (1:3, v/v)). Dioxane or THF can be used instead of acetonitrile.

Column conditioning: 1 mL water (Do not let run the column dry!)

Equilibration: 6 mL acetonitrile or the organic solvent, dilute the sample

Sample application: prepared sample is passed dropwise through the column

Column washing: if necessary 0.5–2 mL acetonitrile or the organic solvent, dilute the sample

Elution: 1–2 mL water (dependent on analyte)

Further analysis: if necessary, evaporate and redissolve in a suitable solvent; HPLC or GC

Creatinine and creatine from water: variation of the organic solvent MN Appl. No. 305590

Column type:
CHROMABOND® HILIC, 3 mL, 500 mg
REF 730593

Sample pretreatment: 250 µL of aqueous sample are diluted with 750 µL tetrahydrofuran, 1,4-dioxane or acetonitrile

Column conditioning: 1 mL water (Do not let run the column dry!)

Equilibration: 5 mL tetrahydrofuran, 1,4-dioxane or acetonitrile

Sample application: prepared sample is passed dropwise through the column

Column washing: 3 x 1 mL tetrahydrofuran, 1,4-dioxane or acetonitrile

Elution: 1 mL water

Further analysis: HPLC with NUCLEODUR® HILIC according to MN Appl. No. 122990 (injection volume: 5 µL)

Recovery rates [%]

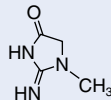
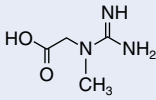
Compound		
	Creatinine	Creatine
Tetrahydrofuran	105 %	101 %
1,4-dioxane	83 %	95 %
Acetonitrile	0 %	97 %

Ordering information

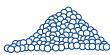
	Volume	Adsorbent weight →		Pack of
		500 mg	1 g	
	CHROMABOND® HILIC polypropylene columns			
	3 mL	730593		50
	6 mL	730594	730596	30
	CHROMABOND® HILIC adsorbent			
			730643	100 g



CHROMABOND® Alox A / Alox N / Alox B aluminum oxide, acidic, neutral, basic

★ Key features

- Alox A: aluminum oxide, acidic pH value 4 ± 0.5
- Alox N: aluminum oxide, neutral pH value 7 ± 0.5
- Alox B: aluminum oxide, basic pH value 9.5 ± 0.5

🔧 Technical characteristics

- Aluminum oxide, high purity, pore volume 0.90 mL/g, particle size 60–150 μm , specific surface 150 m^2/g

Ordering information

	Phases	Volume	Adsorbent weight →			Pack of
			500 mg	1 g	4 g	
	CHROMABOND® Alox polypropylene columns					
	Alox A	3 mL	730452			50
	Alox A	6 mL	730453	730017		30
	Alox A	45 mL			730455	20
	Alox N	3 mL	730446			50
	Alox N	6 mL	730447	730139		30
	Alox N	45 mL			730250	20
	Alox B	3 mL	730429			50
	Alox B	6 mL	730466	730020		30
	Alox B	45 mL			730467	20
	CHROMABOND® Alox glass columns					
	Alox N	6 mL		730139G		30
	Alox B	6 mL		730020G		30
	CHROMABOND® LV-Alox					
	Alox A	15 mL		732210		30
	Alox N	15 mL		732091		30
	Alox B	15 mL		732205		30
		Size →	M	L		
	Phase	Adsorbent weight →	850 mg	1700 mg		Pack of
CHROMAFIX® Alox cartridges						
	Alox N		731844	731845		50
	CHROMABOND® MULTI 96 Alox					
	Alox A				96 x 100 mg	Pack of
	Alox A				738253.100M	1
	Alox N				738251.100M	1
	Alox B				738252.100M	1
	CHROMABOND® Alox adsorbents					
	Alox A				730642	100 g
	Alox N				730641	100 g
	Alox B				730640	100 g



CHROMABOND® normal phases



CHROMABOND® Florisil® magnesium silicate

Technical characteristics

- Matrix magnesium silicate (MgO - SiOH 15:85), high purity, particle size 150–250 µm

Recommended application

- Organic tin compounds, aliphatic carboxylic acids, PCBs, PAHs

Ordering information

	Volume	Adsorbent weight →			Pack of	
		200 mg	500 mg	1 g		2 g
	CHROMABOND® Florisil® polypropylene columns					
	3 mL	730457	730081		50	
	6 mL		730238	730082	730239	30
	CHROMABOND® Florisil® polypropylene columns · BIGpack					
	6 mL			730082.250	250	
	CHROMABOND® Florisil® glass columns					
	6 mL		730238G	730082G	730239G	30
	Size →		L		Pack of	
	Adsorbent weight →		990 mg			
	CHROMAFIX® Florisil® cartridges					
			731848		50	
	CHROMABOND® Florisil® adsorbent					
				730622	100 g	

LV columns and MULTI 96 on request.

CHROMABOND® PA polyamide 6

Technical characteristics

- Matrix polyamide 6, unmodified, high purity, particle size 40–80 µm

Recommended application

- Flavonoids, PAHs

Ordering information

	Volume	Adsorbent weight →			Pack of
		200 mg	500 mg	1 g	
	CHROMABOND® PA polypropylene columns				
	3 mL	730384	730126		50
	6 mL		730007	730127	30
	Size →		S	L	Pack of
	Adsorbent weight →		170 mg	620 mg	
	CHROMAFIX® PA cartridges				
			731849	731851	50
	CHROMABOND® PA adsorbent				
				730660	100 g

Glass columns, LV columns and MULTI 96 on request.



CHROMABOND® SA benzenesulfonic acid cation exchanger based on silica (SCX)

★ Key features

- Adsorbent with hydrophobic and π-π interactions (benzene ring)
- Ion exchange of organic compounds from aqueous matrix
- Elution of interesting compounds with solvent systems, which compensate the ionic and nonpolar interactions, e.g., methanolic HCl

🔧 Technical characteristics

- Base material silica, pore size 60 Å, particle size 45 µm, specific surface 500 m²/g, pH stability 2–8, benzenesulfonic acid modified silica, strongly acidic cation exchanger (capacity ~ 0.5 meq/g)

✓ Recommended application

- Amino acids, amines, chlorophyll, PCBs

Sulfonamides in meat and kidney

MN Appl. No. 302710

B. Pacciarelli et al., Mitt. Gebiete Lebensm. Hyg. 82 (1991) 45–55

Compounds investigated:

sulfaguanidine, sulfanilamide, sulfadiazine, sulfathiazole, sulfapyridine, sulfamerazine, sulfamethizole, sulfadimidine, sulfamethoxyipyridazine, sulfachlorpyridazine, sulfadoxine, sulfadimethoxine

Column type:

CHROMABOND® SA (= SCX), 3 mL, 500 mg
REF 730077

Sample pretreatment: homogenize 10 g sample and 60 mL dichloromethane – acetone (1:1, v/v) for 30 s with a Polytron. Centrifuge the homogenate for 10 min at 2500 rpm. Filter the organic phase and wash the filter residue with a little dichloromethane – acetone. Add 5 mL glacial acetic acid to the filtered extract.

Column conditioning: apply 6 mL hexane and suck air until the column is dry (10 min). Then apply 6 mL dichloromethane – acetone – glacial acetic acid (10:10:1, v/v/v). Now the column must not run dry.

Sample application:

1/10 of the extract volume, flow rate about 2 mL/min; the column must not run dry

Column washing: 5 mL water, then 5 mL methanol; dry for 10 min under vacuum. Now suck NH₃ gas through the column until the acid is neutralized. To control the neutralization process, press air through the column: a wet pH paper should indicate a neutral or basic pH value.

Elution: 3 mL methanol (1–2 mL/min); carefully concentrate the eluate on a rotation evaporator (40 °C/100 mbar), dissolve the residue in 0.5 mL of 5.5% acetonitrile in buffer (1.641 g sodium acetate in 1 L water, adjusted to pH 5 with glacial acetic acid) and centrifuge.

Further analysis: HPLC

Ordering information

	Volume	Adsorbent weight →			Pack of	
		100 mg	200 mg	500 mg		
	CHROMABOND® SA polypropylene columns					
	1 mL	730076			100	
	3 mL		730275	730077	50	
	6 mL			730425	730212	30
	CHROMABOND® SA polypropylene columns · BIGpack					
	3 mL			730077.250	250	
	CHROMABOND® LV-SA					
	15 mL			732083	30	
		Size →	S	M	L	Pack of
		Adsorbent weight →	220 mg	450 mg	920 mg	
	CHROMAFIX® SA cartridges					
			731831	731832	731833	50
					96 x 100 mg	Pack of
	CHROMABOND® MULTI 96 SA					
					738141.100M	1
	CHROMABOND® SA adsorbent					
					730609	100 g

Glass columns on request.



CHROMABOND[®] SB quaternary ammonium anion exchanger based on silica (SAX)

★ Key features

- Not suited for very strong anions such as sulfonic acids because these are difficult to elute

🔧 Technical characteristics

- Base material silica, pore size 60 Å, particle size 45 µm, specific surface 500 m²/g, pH stability 2–8, silica modified with quaternary amine, strongly basic anion exchanger (capacity ~ 0.3 meq/g)

✓ Recommended application

- Organic acids, caffeine, saccharin

Vitamins: folic acid from food (e.g., wheat germs)

MN Appl. No. 300650

 Column type:
CHROMABOND[®] SB (= SAX), 3 mL, 500 mg
REF 730079

Sample pretreatment: homogenize 10 g food sample in 100 mL 0.01 mol/L phosphate buffer pH 7.4 and filter







Column conditioning: 2 column volumes *n*-hexane, then 2 column volumes methanol, finally 2 column volumes dist. water

Sample application: force or aspirate 10 mL of the filtrate through the column

Column washing: 2 column volumes dist. water

Elution: 5 mL 10% sodium chloride in 0.1 mol/L sodium acetate buffer

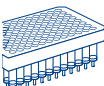
Ordering information

	Volume	Adsorbent weight →			Pack of
		100 mg	200 mg	500 mg	
	CHROMABOND[®] SB polypropylene columns				
	1 mL	730078			100
	3 mL		730322	730079	50
	6 mL			730426	730323
	CHROMABOND[®] SB polypropylene columns · BIGpack				
	3 mL			730079.250	250
	CHROMABOND[®] LV-SB				
	15 mL			732088	30
		Size →	S	M	L
		Adsorbent weight →	230 mg	460 mg	920 mg
	CHROMAFIX[®] SB cartridges				
			731834	731835	731836
	CHROMABOND[®] MULTI 96 SB				
					96 x 100 mg
	CHROMABOND[®] SB adsorbent				
					738101.100M
				730610	100 g

Glass columns on request.



CHROMABOND® PCA propylcarboxylic acid cation exchanger based on silica (WCX)

★ Key features

- Weakly acidic cation exchanger (WCX)

🔧 Technical characteristics

- Base material silica, pore size 60 Å, particle size 45 µm, specific surface 500 m²/g, pH stability 2–8
- Propylcarboxylic acid modified silica

✓ Recommended application

- Strong cations

Ordering information

	Volume	Adsorbent weight →			Pack of
		500 mg	1 g		
	CHROMABOND® PCA polypropylene columns				
	3 mL	730482			50
	6 mL	730483	730484		30
	CHROMABOND® LV-PCA				
	15 mL	732482			30
	CHROMABOND® PCA adsorbent				
			730629		100 g

Glass columns, LV columns, CHROMAFIX® cartridges and MULTI 96 on request.

CHROMABOND® PSA propylsulfonic acid cation exchanger based on silica

★ Key features

- In contrast to the SA phase no π-π interactions

🔧 Technical characteristics

- Base material silica, pore size 60 Å, particle size 45 µm, specific surface 500 m²/g, pH stability 2–8
- Propylsulfonic acid modified silica, very strong cation exchanger (capacity ~ 0.7 meq/g)

✓ Recommended application

- Weak cations

Ordering information

	Volume	Adsorbent weight →			Pack of
		100 mg	500 mg	1 g	
	CHROMABOND® PSA polypropylene columns				
	1 mL	730460			100
	3 mL		730462		50
	6 mL			730464	30
	CHROMABOND® PSA adsorbent				
			730630		100 g

Glass columns, LV columns, CHROMAFIX® cartridges and MULTI 96 on request.

For further applications on CHROMABOND® phases visit our online application database at www.mn-net.com/apps



CHROMABOND® Drug special silica phase for drug analysis

🔧 Technical characteristics

- Base material silica, pore size 60 Å, particle size 45 µm, specific surface 500 m²/g, pH stability 2–8
- Special bifunctional modification - C₈: RP interaction
SA: strong cation exchanger / benzenesulfonic acid

✅ Recommended application

- Enrichment of acidic, neutral and basic drugs from urine or plasma

Drugs from blood serum

MN Appl. No. 302020

W. Weinmann, M. Renz, C. Pelz, P. Brauchle, S. Vogt, S. Pollak, Blutalkohol 35 (1998), 1–9

Compounds investigated: benzoylcegonine, amphetamine, codeine, morphine

📏 Column type:

CHROMABOND® Drug, 3 mL, 200 mg

REF 730168

Sample pretreatment: 0.1 mL blood serum are mixed with 1.4 mL of a 0.1 mol/L KH₂PO₄ buffer (pH 6) and centrifuged

Column conditioning: 2 mL methanol, then 2 mL 0.1 mol/L KH₂PO₄ buffer (pH 6)

Sample application: slowly force or aspirate the supernatant from the sample pretreatment through the column

Column washing: 2 mL 0.1 mol/L KH₂PO₄ buffer (pH 6), then 1 mL 0.1 mol/L acetic acid, then 2 mL methanol; finally dry the column first by centrifugation (2 min, 4000 U/min), then under vacuum for 10 min

Elution: 1.5 mL dichloromethane – 2-propanol – 25 % ammonia solution (80:20:2, v/v/v)

Further analysis: HPLC with NUCLEOSIL® 100-5 C₁₈ AB

(application 110240) or GC/MS after derivatization with perfluoropropanoic acid pentafluoropropanol, e.g., with column OPTIMA® 5 MS, 0.25 µm film, 30 m x 0.25 mm ID, (REF 726220.30)

Ordering information

	Volume	Adsorbent weight →			Pack of
		100 mg	200 mg	500 mg	
	CHROMABOND® Drug polypropylene columns				
	1 mL	730681			100
	3 mL		730168	730684	50
	6 mL			730682	30
	CHROMABOND® Drug polypropylene columns · BIGpack				
	3 mL		730168.250		250
	CHROMABOND® LV-Drug				
	15 mL		732168		30
				96 x 100 mg	Pack of
	CHROMABOND® MULTI 96 Drug			738161.100M	1

For further applications on CHROMABOND® phases visit our online application database at www.mn-net.com/apps



CHROMABOND® Drug II extraction of THC and derivatives, acidic analytes from biological fluids (urine, blood, etc.)

★ Key features

- Two primary retention mechanisms facilitate use of very strong interferant-eluting solvents, resulting in very pure extracts

🔧 Technical characteristics

- Base material silica, pore size 60 Å, particle size 45 µm, specific surface 500 m²/g, pH stability 2-8
- Special bifunctional modification - C₈: RP interaction
SB: strong anion exchanger/quaternary amine -NR₃⁺

✓ Recommended application

- Extraction of THC and derivatives from urine, blood, serum, plasma
- Acidic analytes from biological fluids

11-nor-Δ⁹-THC-carboxylic acid from urine

MN Appl. No. 303880

Compounds investigated: tetrahydrocannabinol, 11-nor-Δ⁹-THC-carboxylic acid

Column type:

CHROMABOND® Drug II, 3 mL, 200 mg
REF 730680

Sample pretreatment:

add 300 µL 10 mol/L potassium hydroxide solution and internal standard (for GC/MS deuterium labeled 11-nor-Δ⁹-THC-carboxylic acid) to 5 mL urine. Vortex the sample and then hydrolyze at 60 °C for 15 min. Cool sample and add 200 µL glacial acetic acid and 2 mL 50 mmol/L ammonium acetate solution. If necessary, adjust sample pH to 6-7.

Column conditioning:

2 mL methanol, 2 mL dist. water; equilibrate column with 2 mL 50 mmol/L ammonium acetate buffer

Sample application: slowly force or aspirate the sample through the column (1-2 mL/min)

Column washing: elute interferants with 10 mL methanol – water (1:1, v/v); dry the column for 10 min at high vacuum; further wash the column with 2 mL acetonitrile and dry for another 2 min

Elution: elute THC metabolites with 3 mL hexane – ethyl acetate – glacial acetic acid (75:25:1, v/v/v)

Recovery rates: 70-80 %

Further analysis: we recommend GC/MS on an OPTIMA® 5 MS column after derivatization with 50 µL Silyl-991 (REF 701480; BSTFA – TMCS 99:1) at 70 °C for 20 min; inject 1-2 µL onto the GC column.

Ordering information

	Volume	Adsorbent weight →			Pack of
		100 mg	200 mg	500 mg	
	CHROMABOND® Drug II polypropylene columns				
	1 mL	730685			100
	3 mL		730680	730686	50
	6 mL			730683	30
	CHROMABOND® LV-Drug II				
	15 mL		732681		30
				96 x 100 mg	Pack of
	CHROMABOND® MULTI 96 Drug II			738680.100M	1

For further applications on CHROMABOND® phases visit our online application database at www.mn-net.com/apps



CHROMABOND® Tetracycline special phase for enrichment of tetracyclines

★ Key features

- Silica phase with special C₁₈ modification, tested for tetracyclines
- Constant recovery rates for the title compounds (every batch individually tested)

✓ Recommended application

- Tetracyclines from biological samples

Tetracyclines from musculature

MN Appl. No. 302030

Private communication of Mr. Lippold, Chemisches Landesuntersuchungsamt (Chem. Research Agency) Freiburg, Germany

Compounds investigated: tetracycline, oxytetracycline, chlorotetracycline (100–500 mg/kg)

Column type:

CHROMABOND® Tetracycline, 6 mL, 500 mg
REF 730315

Sample pretreatment: see detailed description in appl. 302030 at www.mn-net.com/apps

Column conditioning: 1 column volume methanol, 1 column volume dist. water, then 1 column volume EDTA – succinate buffer

CAUTION: DO NOT LET THE COLUMN RUN DRY!

Sample application: force or aspirate 50 mL of the eluate from the sample pretreatment through the CHROMABOND® column

Column washing: 2 mL dist. water (removal of Cu ions), 2 mL *n*-hexane

Elution: 7.5 mL methanol into a 25-mL tapered flask. Add 1 mL of an ethylene glycol – methanol mixture (22 g ethylene glycol filled up to 100 mL with methanol) and evaporate to dryness with a rotation evaporator (max. 40 °C). Fill up the residue to 400 mL with 0.1 mol/L McIlvain-EDTA buffer (52.5 g citric acid · H₂O, 44.5 g Na₂HPO₄ · H₂O and 93 g Titriplex III dissolved in 2.5 L dist. water, adjusted to pH 4 with NaOH).

Recovery rates: tetracycline, chlorotetracycline ~50–70 %, oxytetracycline ~60–80 %

Further analysis: HPLC with column 250 x 4 mm NUCLEOSIL® 100-5 C₁₈ HD (application 110710)

Ordering information

	Volume	Adsorbent weight → 500 mg	Pack of
	CHROMABOND® Tetracycline polypropylene columns		
	6 mL	730315	30

Product for research purposes only (see page 395)



CHROMABOND® HR-P-AOX AOX from waters with high salt loads (DIN 38409 – H22)

Technical characteristics

- Special PS/DVB phase

Recommended application

- Extraction of AOX (adsorbable organically bonded halogens) from waters containing high salt loads or organic pollutants in accordance with DIN 38409 – H22

AOX from water (DIN 38409 – H22)

MN Appl. No. 302080

Column type:
CHROMABOND® HR-P-AOX, 6 mL, 500 mg
REF 730111.AOX

Column conditioning: 5 mL methanol, 10 mL dist. water
Do not let the column run dry!

Sample application: force or aspirate 100 mL original or diluted sample (pH 1) through the column (3–5 mL/min). Do not let the column run dry!

Column washing: 50 mL nitrate rinsing solution (dissolve 17 g NaNO₃ in 100 mL dist. water, add 1.4 mL HNO₃ 10 mol/L, fill up to 1000 mL; take 50 mL and fill to 1000 mL with dist. water). Discard the flowthrough.

Elution: slowly aspirate 1 x 1 mL, then 1 x 4 mL methanol and 10 mL dist. water through the column.

Collect eluates in 100 mL volumetric flask and fill to 100 mL with dist. water.

Ordering information

	Volume	Adsorbent weight →		Pack of
		200 mg	500 mg	
	CHROMABOND® HR-P-AOX polypropylene columns			
	6 mL	730119.AOX	730111.AOX	30

CHROMABOND® C₁₈ PAH octadecyl silica for PAH analysis

Technical characteristics

- Base material silica, pore size 60 Å, particle size 45 µm, specific surface 500 m²/g, pH stability 2–8
- Special octadecyl modification for the enrichment of PAHs, not endcapped, carbon content 14 %

Recommended application

- PAHs from water

PAHs from water

MN Appl. No. 301250

Column type:
CHROMABOND® C₁₈ PAH, 6 mL, 2 g
REF 730166

Sample pretreatment: mix 1000 mL water sample with 10 mL methanol
Column conditioning: 1 column volume methanol, then 1 column volume dist. water

Sample application: aspirate 1000 mL water sample through the column (~ 15–20 mL/min), then dry column (stream of nitrogen or 24 h in a desiccator over P₂O₅)

Elution: elute with 4 mL acetonitrile – benzene (3:1, v/v) and then evaporate or fill up to the volume required

Recovery rates (50 ng/L per component): Naphthaline 87 %, Acenaphthylene 89 %, Acenaphthene 90 %, Fluorene 82 %, Phenanthrene 85 %, Anthracene 90 %, Fluoranthene 89 %, Pyrene 89 %, Benz[a]anthracene 87 %, Chrysene 95 %, Benzo[b]fluoranthene 91 %, Benzo[k]fluoranthene 89 %, Benzo[a]pyrene 90 %, Dibenz[ah]anthracene 97 %, Benzo[ghi]perylene 91 %, Indeno[1,2,3-cd]pyrene 96 %

Ordering information

	Volume	Adsorbent weight →		Pack of
		2 g		
	CHROMABOND® C₁₈ PAH polypropylene columns			
	6 mL	730166		30
	CHROMABOND® C₁₈ PAH glass columns			
	6 mL	730166G		30
	CHROMABOND® C₁₈ PAH adsorbent			
		730616		100 g



CHROMABOND® NH₂/C₁₈ combination phase for PAH analysis

★ Key features

- Special combination phase:
Aminopropyl phase for removal of interfering humic acids
octadecyl phase for the enrichment of PAHs

☑ Recommended application

- PAHs from water containing humic acids

PAHs from water containing humic acids

MN Appl. No. 301260

Column type:

CHROMABOND® NH₂/C₁₈, 6 mL, 500 mg/1 g glass column
REF 730620G

Sample pretreatment: mix 500 mL water sample with 25 mL 2-propanol
Column conditioning: 10 mL dichloromethane, 10 mL methanol, then 10 mL dist. water – 2-propanol (9:1, v/v)

Sample application: aspirate 500 mL prepared water sample through the column (~ 5 mL/min)

Column washing: 2 mL dist. water – 2-propanol (9:1, v/v), then dry column (about 20 min, vacuum)

Elution: 4 x 0.5 mL CH₂Cl₂ (let percolate first 0.5 mL into the column packing without vacuum, then apply light vacuum), if necessary evaporate in a stream of N₂ and fill up with a suitable solvent

Ordering information



Volume	Adsorbent weight → 500/500 mg	500 mg / 1 g	Pack of
CHROMABOND® NH₂/C₁₈ polypropylene columns			
6 mL	730618	730620	30
CHROMABOND® NH₂/C₁₈ glass columns			
6 mL	730618G	730620G	30

CHROMABOND® CN/SiOH combination phase for PAH analysis

★ Key features

- Cyanopropyl phase for selective adsorption of polycyclic aromatics via π-π interactions
- Unmodified silica phase for removal of polar compounds

☑ Recommended application

- Extraction of the 16 PAHs according to EPA from soil samples

PAHs from soil

MN Appl. No. 301310

Column type:

CHROMABOND® CN/SiOH, 6 mL, 500/1000 mg
REF 730135

Sample pretreatment: dry 30 g soil with sodium sulfate and reflux 4 h with 250 mL petroleum ether in a Soxhlet extractor. For low PAH contents (colorless or weakly colored extracts) concentrate extract to 1/10 of its volume in a rotation evaporator.

Column conditioning: 4 mL petroleum ether

Sample application: aspirate 20 mL of the extract through the column
Column washing: 2 mL petroleum ether

Elution: 2 x 2 mL acetonitrile – toluene (3:1, v/v), then evaporate or fill to the volume required

Further analysis: HPLC, e.g., with column 100 x 4 mm NUCLEODUR® C₁₈ PAH, 3 μm, REF 760783.40 according to application 123820 (see page 227)
For recovery rates see application 301310 at www.mn-net.com/apps

Ordering information



Volume	Adsorbent weight → 500 mg / 1 g	Pack of
CHROMABOND® CN/SiOH polypropylene columns		
3 mL	730112	50
6 mL	730135	30
CHROMABOND® CN/SiOH glass columns		
6 mL	730135.250	250
CHROMABOND® CN/SiOH glass columns · BIGpack		
6 mL	730135G	30



CHROMABOND® Na₂SO₄/Florisil® hydrocarbons from water in accordance with DIN H-53 / ISO DIS 9377-4

★ Key features

- Special combination phase of sodium sulfate and Florisil®

✓ Recommended application

- Hydrocarbons from drinking, surface and waste waters

Hydrocarbons from water

MN Appl. No. 302090

Column type:

CHROMABOND® Na₂SO₄/Florisil®, 6 mL, 2 g/2 g glass column
REF 730249G

Internal standard solution: dissolve 20 mg *n*-tetracontane (C₄₀H₈₂) in petroleum ether, add 20 mL *n*-decane (C₁₀H₂₂) and fill up to one liter with petroleum ether. For the preparation of the extraction solution dilute standard solution 1:10 with petroleum ether.

Sample pretreatment: adjust 900 mL water (10 °C) with HCl (12 mol/L) to pH 2 and add 80 g MgSO₄. Add 50 mL of the extraction solution, close the bottle and stir the suspension intensely for 30 min. Add enough dist. water to separate the organic from the aqueous phase.

Column conditioning: 5 mL petroleum ether

Sample application: slowly aspirate or force the sample through the column

Elution: wash with 10 mL petroleum ether. Evaporate the combined solution from sample application and elution to 1 mL at about 75 °C. If necessary, fill up to 1 mL again. (If the hydrocarbon content is high, evaporation to 1 mL may not be necessary.)

Recovery rates: must be > 80 % for *n*-tetracontane

Ordering information



Volume	Adsorbent weight → 2 g / 2 g	Pack of
CHROMABOND® Na₂SO₄/Florisil® polypropylene columns		
6 mL	730249	30
CHROMABOND® Na₂SO₄/Florisil® glass columns		
6 mL	730249G	30
CHROMABOND® Na₂SO₄/Florisil® glass columns · BIGpack		
6 mL	730249G.250	250





CHROMABOND® NAN special phase for PCB analysis

★ Key features

- N: sodium sulfate for removal of trace water
- A: SiOH/AgNO₃ phase for removal of sulfur, sulfur-containing and polar compounds

✓ Recommended application

- Extraction of PCBs from sludge

PCB from sludge

MN Appl. No. 301400

Compounds investigated: polychlorinated biphenyls (PCB)
This method can also be used for soil samples.

Column type:
CHROMABOND® NAN, 6 mL, 700/2000/700 mg
REF 730149

Sample pretreatment:
extract 2 g lyophilized sludge with 70 mL *n*-hexane, evaporate extract and fill to 10 mL with *n*-hexane





Column conditioning: 10 mL *n*-hexane

Sample application: aspirate 2 mL extract into the column

Elution: slowly aspirate 40 mL *n*-hexane through the column with light vacuum, then evaporate and fill to 5 mL with *n*-hexane

Recovery rates: PCB-28 104 %, PCB-52 100 %, PCB-101 99 %, PCB-138 98 %, PCB-153 101 %, PCB-180 98 %, PCB-209 104 %

Ordering information

	Volume	Adsorbent weight →		Pack of
		400/1400/400 mg	700/2000/700 mg	
	CHROMABOND® NAN polypropylene columns			
	3 mL	730109		50
	6 mL		730149	30
	CHROMABOND® NAN polypropylene columns · BIGpack			
	6 mL		730149.250	250
	CHROMABOND® NAN glass columns			
	6 mL		730149G	30
	CHROMABOND® NAN adsorbent*			
			730619	100 g

* This product contains harmful substances which must be specially labeled as hazardous. For detailed information please see SDS.

For further applications on CHROMABOND® phases visit our online application database at www.mn-net.com/apps



CHROMABOND® SA/SiOH combination phase for PCB analysis

★ Key features

- SA: strongly acidic cation exchanger based on silica with benzenesulfonic acid modification
- SiOH: unmodified silica for removal of polar compounds

✓ Recommended application

- Extraction of PCBs from waste oil (hexane extract)

PCB from waste oil MN Appl. No. 301390

Column type:
CHROMABOND® SA/SiOH, 3 mL, 500/500 mg
REF 730132

Column conditioning: 1 mL *n*-hexane

Sample application: apply 250 µL waste oil sample to the column and aspirate or force it into the adsorbent with 2 x 1 mL *n*-hexane

Elution: aspirate or force another 2 x 500 µL *n*-hexane through the column; collect all *n*-hexane fractions and if necessary adjust concentration for subsequent analysis by either evaporating *n*-hexane in a stream of nitrogen or by dilution with *n*-hexane

Recovery rates: PCB-28 97 %, PCB-52 96 %, PCB-101 95 %, PCB-138 90 %, PCB-153 95 %, PCB-180 96 %, PCB-209 100 %

Ordering information

	Volume	Adsorbent weight → 500/500 mg	Pack of
	CHROMABOND® SA/SiOH polypropylene columns		
	3 mL	730132	50
	6 mL	730235	30
	CHROMABOND® SA/SiOH polypropylene columns · BIGpack		
	3 mL	730132.250	250

For further applications on CHROMABOND® phases visit our online application database at www.mn-net.com/apps

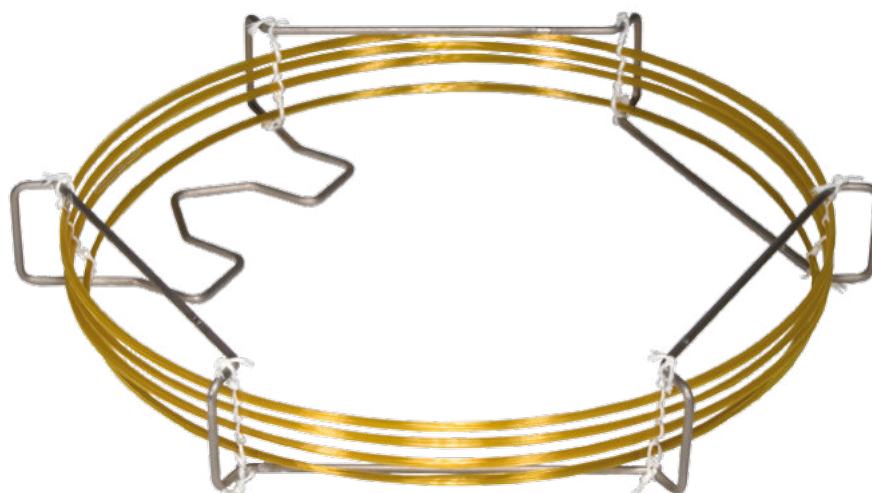

PCBs can be separated successfully with e.g., OPTIMA® XLB (see page 317).



CHROMABOND® SiOH-H₂SO₄/SA combination phase for PCB analysis

★ Key features

- SiOH-H₂SO₄: H₂SO₄-impregnated silica phase for oxidation of accompanying compounds to ionic and/or polar compounds
- SA: strongly acidic cation exchanger based on silica with benzenesulfonic acid modification for removal of ionic and sulfur-containing compounds
- This combination column is used together with a SiOH column. Both columns together are available as Kombi-Kit PCB.

✓ Recommended application

- Extraction of PCBs from oil with reference to German industrial standard DIN 51527, part 1

PCB in oil samples

MN Appl. No. 301380

determination with reference to German industrial standard DIN 51527

Column type:

CHROMABOND® SiOH-H₂SO₄/SA, 3 mL, 500/500 mg and
 CHROMABOND® SiOH, 3 mL, 500 mg
 REF 730085 and 730073
 or Kombi-Kit PCB, REF 730125

Sample pretreatment: extract oil-contaminated solids with *n*-hexane. Homogenize other oil samples and dissolve 1.5 to 2.0 g in 50 mL *n*-hexane. Water which may cause turbidity can be removed with sodium sulfate.

Column conditioning: let 1 mL *n*-hexane flow through the CHROMABOND® SiOH-H₂SO₄/SA column

Sample application: aspirate or force 500 µL sample through the CHROMABOND® SiOH-H₂SO₄/SA column. This phase offers better removal of interfering substances due to sulfonation. Place CHROMABOND® SiOH-H₂SO₄/SA column on top of the SiOH column with the aid of an adapter and after at least 30 s flush sample into the SiOH column with 2 x 1 mL *n*-hexane.

Elution: elute SiOH column with 3 x 0.5 mL *n*-hexane; adjust to a suitable concentration for subsequent GC analysis by evaporation of *n*-hexane in a stream of nitrogen or by dilution with *n*-hexane

Recovery rates: PCB-28 99 %, PCB-52 95 %, PCB-101 99 %, PCB-138 94 %, PCB-153 99 %, PCB-180 96 %, PCB-209 101 %

Ordering information

	Volume	Adsorbent weight → 500/500 mg	Pack of
	CHROMABOND® SiOH-H₂SO₄/SA polypropylene columns		
	3 mL	730085	50
	CHROMABOND® SiOH-H₂SO₄/SA polypropylene columns · BIGpack		
	3 mL	730085.250	250
	CHROMABOND® SiOH-H₂SO₄/SA glass columns		
	3 mL	730085G	50
	Kombi-Kit for extraction of PCB from oil with reference to DIN 51527, part 1		
	25 columns each of CHROMABOND® SiOH-H ₂ SO ₄ /SA and CHROMABOND® 730125 SiOH		1



CHROMABOND® QuEChERS special silica phase for determination of pesticides in food samples

★ Key features

- Reliable CHROMABOND® adsorbents
- Different packaging with mixes for all established methods
- Convenient to use - pre-weighed and mixed
- Saves time and money
- Increases efficiency in the laboratory
- Individual combination of mixes on request

✓ Recommended application

- Special SPE phase for quick and cheap determination of pesticides in strongly matrix-contaminated samples by GC or HPLC
- QuEChERS methode =
Quick Easy Cheap Effective Rugged Safe

CHROMABOND® Diamino special silica phase for determination of pesticides in food samples

★ Key features

- Base material silica, pore size 60 Å
- Removes polar compounds (e.g., organic acids, pigments, sugars) from matrices like fruit or vegetables

🔧 Technical characteristics

- Particle size 45 µm, specific surface 500 m²/g, pH stability 2–8
- Primary and Secondary Amine functions (PSA), 5 % C

Similar phases

- Supelclean™ PSA, Bond Elut® PSA

Food analysis

QuEChERS methods and ready-mixes

Within a few years after its development by Anastassiades et al. [1] the QuEChERS method has gained a leading position for determination of pesticide residues in food samples by GC-MS or LC-MS, allowing rapid and cheap clean-up of strongly matrix-contaminated samples.

Advantages of QuEChERS in comparison with classical clean-up methods:

- High through-put, due to easy handling and time-saving procedure
- Low consumption of solvents
- No need for chlorinated solvents
- Suitable for a variety of pesticides
- Rugged method with high and safe recovery rates
- Broad applications for various foods

To optimize the extraction of pH-dependent compounds, to minimize decomposition of sensitive substances, and to broaden the matrix spectrum, different modifications of the QuEChERS method have been elaborated. These mixes differ in the type of buffer agent used and in this way the resulting pH value of the aqueous sample during the extraction vary.

Today three methods are used:

- Original (non-buffered) [1]
- AOAC Standard 2007.1 (acetate buffered) [2]
- EN 15662 (citrate buffered) [3]

In particular the buffered versions are commonly used.

All methods require two proceeding steps:

- Extraction: pesticides are transferred from the aqueous to the organic layer (often acetonitrile)
- Clean-up: Interfering substances (like e.g., lipids, pigments), which were also extracted with the organic layer, are removed by special adsorbents

Analysis: Sample is analyzed by GC-MS or LC-MS/MS

The QuEChERS procedure is described in the following in accordance with EN 15662:2008. An extraction mix and a clean-up mix is required.

Step 1 – Extraction and salting-out

1. Homogenize sample (e.g., with dry ice in a blender)
2. Weigh 10 g of the sample into a centrifuge tube
3. Add 10 mL of acetonitrile and internal standard
4. Shake vigorously for 1 minute
5. Add extraction mix to centrifuge tube
Optional: check pH and adjust pH to 5.0–5.5 with 5 mol/L aqueous NaOH.
6. Shake vigorously for 1 minute
7. Centrifuge for 5 minutes at > 3000 g. For the determination of pesticides with acidic groups, the raw extract should be analyzed directly (preferably by LC/MS ESI neg.)



Step 2 – Clean-up

1. Transfer an aliquot of the supernatant to a centrifuge tube containing a clean-up mix
2. Shake for 30 seconds
3. Centrifuge for 5 minutes at > 3000 g

Analysis

Transfer supernatant to vial, acidify with 5 % formic acid in acetonitrile (10 µL/mL extract) and analyze the sample by LC-MS or GC-MS. MACHEREY-NAGEL offers a variety of pre-weighed and mixed extraction and clean-up mixes, which are in accor-

dance with the above mentioned standardized methods, specially adapted to the different sample matrices. These matrices differ in their characteristics e.g., low or high fat content or different amounts of pigments.

If you require an individual mix, which differs in the composition from the below mentioned mixes, please contact us.

Additional MACHEREY-NAGEL offers the reliable adsorbent CHROMABOND® Diamino (PSA) as bulk material.

The following table provides guidance for the choice of different QuEChERS mixes:

Step 1 – Extraction and salting-out

Method	Sample weight	Solvent	Content of mix	Mix
EN 15662:2008, citrate-buffered [2]	10 g	10 mL acetonitrile	4 g MgSO ₄ , 1 g NaCl, 0.5 g Na ₂ H citrat · 1.5 H ₂ O, 1 g Na ₃ citrat · 2 H ₂ O	Mix I
AOAC 2007.01, acetate-buffered [3]	15 g	15 mL 1 % acetic acid in acetonitrile	6 g MgSO ₄ , 1.5 g NaOAc	Mix II
Original non-buffered [1]	10 g	10 mL acetonitrile	4 g MgSO ₄ , 1 g NaCl	Mix XII

Step 2 – Clean-up

Sample property	Content of mix	EN 15662	AOAC 2007.01
Low fat content e.g., apple, asparagus, broccoli, pear, pineapple, strawberry	MgSO ₄ Diamino (PSA)	Mix III	Mix XX
Moderate content of chlorophyll and carotinoids e.g., carrot, lettuce	MgSO ₄ Diamino (PSA) Carbon	Mix IV	Mix XVII
Higher content of chlorophyll and carotinoids e.g., pepper, spinach, blackberry, raspberry	MgSO ₄ Diamino (PSA) Carbon	Mix V	–
Higher fat content e.g., avocado, cereals, nuts, beef, chicken, pork, dairy products, soil, oils, baby food	MgSO ₄ Diamino (PSA) C ₁₈ ec	Mix VI	Mix XIX



Adsorbents and what they are used for

MgSO ₄	removes excess of water
NaCl	for phase separation
CHROMABOND® Diamino (PSA) (Primary Secondary Amine)	removes organic and fatty acids, sugars and anthocyanin pigments
CHROMABOND® C ₁₈ ec (reversed phase modified silica)	traps nonpolar compounds, e.g., lipids
CHROMABOND® Carbon (GCB) (Graphitized Carbon Black)	removes pigments and sterols (please note: planar pesticides are also removed)

Further information can be found online at www.mn-net.com or www.quechers.com



Ordering information

	Volume	Adsorbent weight →		Pack of
		200 mg	500 mg	
	CHROMABOND® Diamino polypropylene columns			
	3 mL	730561		50
	6 mL		730562	30
	CHROMABOND® Diamino adsorbent			
		730653.20		20 g
		730653		100 g

Ordering information

Method	Mix	Volume	Content	Pack of	REF
Extraction mix 15 mL centrifuge tubes with screw cap					
EN 15662	Mix I	15 mL	4 g MgSO ₄ , 1 g NaCl, 0.5 g Na ₂ H Citrate · 1.5 H ₂ O, 1 g Na ₃ Citrate · 2 H ₂ O	50	730970
AOAC 2007.01	Mix II	15 mL	6 g MgSO ₄ , 1.5 g NaOAc	50	730971
Original	Mix XII	15 mL	4 g MgSO ₄ , 1 g NaCl	50	730648
Clean-up-Mix 15 mL and 2 mL centrifuge tubes with screw cap					
EN 15662	Mix III	15 mL	0.90 g MgSO ₄ , 0.15 g CHROMABOND® Diamino	50	730972
EN 15662	Mix IV	15 mL	0.90 g MgSO ₄ , 0.15 g CHROMABOND® Diamino, 15 mg CHROMABOND® Carbon	50	730973
EN 15662	Mix V	15 mL	0.90 g MgSO ₄ , 0.15 g CHROMABOND® Diamino, 45 mg CHROMABOND® Carbon	50	730975
EN 15662	Mix VI	15 mL	0.90 g MgSO ₄ , 0.15 g CHROMABOND® Diamino, 150 mg CHROMABOND® C ₁₈ ec	50	730974
AOAC 2007.01	Mix XVII	2 mL	0.15 g MgSO ₄ , 50 mg CHROMABOND® Diamino, 50 mg CHROMABOND® Carbon	50	730996.2
AOAC 2007.01	Mix XIX	15 mL	0.15 g MgSO ₄ , 50 mg CHROMABOND® Diamino, 50 mg CHROMABOND® C ₁₈ ec	50	730657
AOAC 2007.01	Mix XX	15 mL	1.20 g MgSO ₄ , 0.40 g CHROMABOND® Diamino	50	730658

Further information can be found online at www.mn-net.com or www.quechers.com



CHROMABOND® ABC18 special phase for analysis of acrylamide in food

★ Key features

- Octadecyl silica phase with ion exchange functions for acrylamide analysis

✓ Recommended application

- Clean-up of acrylamide from ultra-heated starch-containing food, such as potato chips and other snacks, french fries, crispbread, cereals etc.

Ordering information

	Volume	Adsorbent weight → 500 mg	Pack of
	CHROMABOND® ABC18 polypropylene columns		
	6 mL	730533	30

Important notes

- For “Determination of Acrylamide in Foods, SPE Clean-up Procedure for LC-MS/MS” please see application 303580 at www.mn-net.com/apps
- Acrylamide is created at temperatures above 100 °C from sugar and proteins, e.g., from potatoes or grain during the process of frying, baking, roasting or grilling. The formation depends on temperature, starting at 120 °C and increasing with more elevated temperatures. In cooked food, no acrylamide is found.
- Minimum concentration of acrylamide should be 70 µg/kg.
- The procedure includes no concentration step.
- Acrylamide and the isotopically labeled form, is carcinogenic, mutagenic and neurotoxic.

CHROMABOND® Carbon A

✚ Technical characteristics

- Base material activated carbon, highly porous, spherical particles, specific surface >1000 m²/g

✓ Recommended application

- Acrylamide from water according to DIN 38413-6 (e.g., application 306140)

Enrichment of acrylamide from water acc. to DIN 38413

MN Appl. No. 306140

Column type:

CHROMABOND® Carbon A, 6 mL, 1000 mg
REF 730167

Sample pretreatment: A drinking water sample was taken according to DIN 38402. The sample was treated with 100 mg/L sodium thiosulfate pentahydrate to reduce oxidizing species. 40 mg/L sodium azide was then added to avoid microbiological degradation. An aliquot of 500 mL pretreated water sample was spiked with 50 ng acrylamide.

Column conditioning: 8 mL methanol and 8 mL water

Sample application: sample was aspirated at a flow of 20 mL/min

Column washing: 1 mL water

Drying: 15 min nitrogen or air flow

Elution: 5 x 2 mL methanol

Concentration: eluate was concentrated to 1 mL by heating at 40 °C under a slight nitrogen stream

Recovery rates: 81 % (SD: 5 % [n=6])

Further analysis: HPLC-MS/MS in reference to appl. no. 127530

Ordering information

	Volume	Adsorbent weight → 500 mg	1 g	Pack of
	CHROMABOND® Carbon A polypropylene columns			
	6 mL	730165	730167	30



CHROMABOND® PL special phase for removal of phospholipids

★ Key features

- CHROMABOND® PL products are designed for internal protein precipitation. External protein precipitation could be necessary in order to prevent upper frit adsorbent bed clogging.

✓ Recommended application

- Removal of phospholipids
- Standard protocol see application 306110

Standard protocol for removal of phospholipids with internal protein precipitation

MN Appl. No. 306110

Column type:

CHROMABOND® PL, 1 mL, 30 mg, REF 730703 or
CHROMABOND® Multi 96 PL, 96 x 30 mg, REF 738702.030M

Column conditioning: none

Sample application: add up to 100 µL sample onto column / into well
Protein precipitation (internal): add protein precipitation reagent (e.g., final ratio of 3:1 to 4:1 of 1 % formic acid in acetonitrile : sample)

Mixing: mix thoroughly, avoiding cross contamination

Sample collection: slowly elute using vacuum or positive pressure

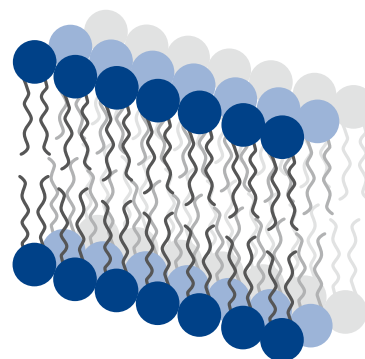

Ordering information

	Volume	Adsorbent weight → 30 mg	Pack of
	CHROMABOND® PL polypropylene columns		
	1 mL	730703	100
	96 x 30 mg		
	CHROMABOND® MULTI 96 PL		
		738702.030M	1

CHROMABOND® Dry (Na₂SO₄) special phase for drying of organic samples

★ Key features

- Anhydrous high-purity sodium sulfate which forms Glauber's salt with traces of water

✓ Recommended application

- Removal of traces of water from organic solutions.
- For removal of larger quantities of water several cartridges can be combined in series.

Ordering information

	Size → Adsorbent weight →	S 780 mg	M 1500 mg	L 2800 mg	Pack of
	CHROMAFIX® Dry cartridges				
		731852	731853	731854	50

For further applications on CHROMABOND® phases visit our online application database at www.mn-net.com/apps

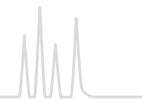

CHROMABOND® PTS and PTL PTS and PTL columns for phase separation

★ Key features

- Automatic separation of a two-phase mixture without separation funnel
- Two-phase mixtures are completely applied to the column and the phase boundary is determined without further work. The special membrane automatically stops the flow when the lower phase has passed. The upper phase remains in the column, thus both phases are available for further analysis.
- Columns must not be run with vacuum or pressure

✓ Recommended application

- PTS: for solvents heavier than water, e.g., trichloromethane, dichloromethane maximum size 150 mL
- PTL: for solvents lighter than water, e.g., diethyl ether, hexane maximum size 70 mL

Ordering information

Column volume	Pack of [columns]	REF
CHROMABOND® PTS for solvents heavier than water		
1 mL	100	730710
3 mL	100	730712
6 mL	100	730714
15 mL	100	730716
30 mL	100	730718
45 mL	50	730720
70 mL	50	730722
150 mL	20	730724
CHROMABOND® PTL for solvents lighter than water		
1 mL	100	730730
3 mL	100	730732
6 mL	100	730734
15 mL	100	730736
30 mL	100	730738
45 mL	50	730740
70 mL	50	730742

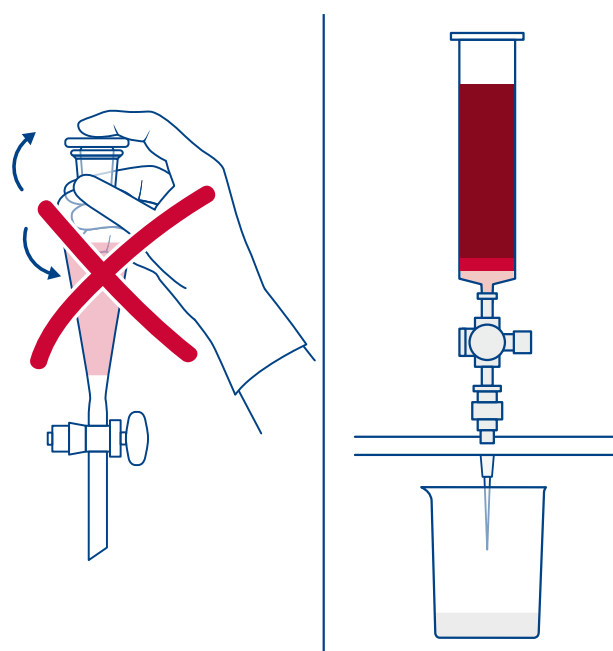

Ideal tool for breaking emulsions

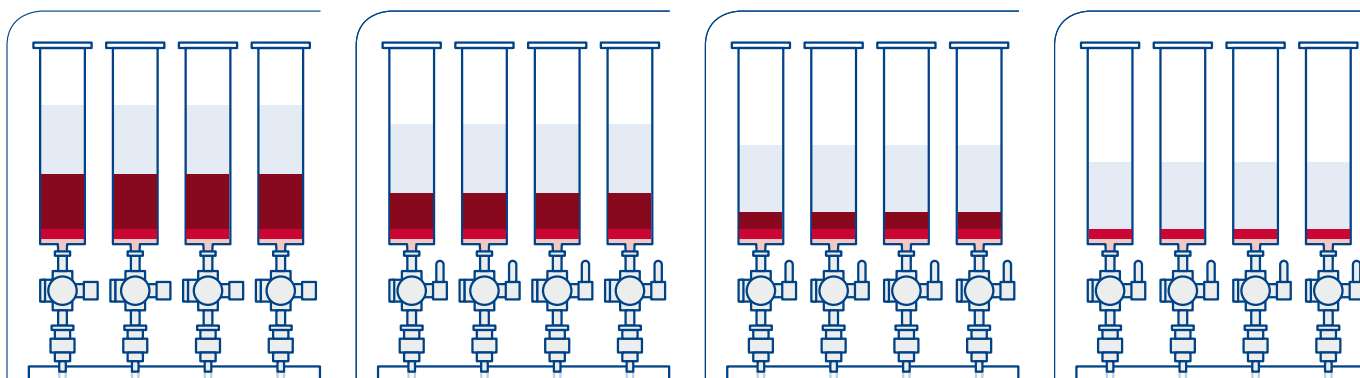

CHROMABOND® PTL in action: organic upper phase (colorless), aqueous lower phase (red)



CHROMABOND® XTR for liquid-liquid extraction

★ Key features

- Base material coarse-grained kieselguhr (also known as diatomaceous earth, hydromatrix, celite), large pore size, high pore volume, constantly high batch-to-batch quality, pH working range 1–13
- Advantages:
 - Fast, reproducible and economical
 - Simultaneous preparation of several samples
 - No problems with phase separation
 - No formation of emulsions
 - High recovery rates
 - Saving of time and solvents
 - Organic solutions need not to be dried after separation

✓ Recommended application

- Liquid-liquid extraction of highly viscous aqueous solutions such as physiological fluids (blood, plasma, and serum) in clinical chemistry, dyes in textiles, environmental and food analysis without use of a separation funnel
- High water loadability without breakthrough of water during elution with organic solvents also suited for removing small amounts of water from solvents which are not miscible with water

Solvents applicable for elution

- Diethyl ether
- *tert* butyl methyl ether
- Ethyl acetate
- *n*-hexane
- Cyclohexane
- Toluene
- Dichloromethane (methylene chloride)
- Trichloromethane (chloroform)
- Trichloromethane – methanol (90:10, v/v)
- Trichloromethane – methanol (85:15, v/v)
- Diethyl ether – ethanol (90:10, v/v)
- Diethyl ether – ethanol (80:20, v/v)
- Dichloromethane – 2-propanol (90:10, v/v)
- Dichloromethane – 2-propanol (85:15, v/v)

Eluents with too high alcohol contents cause an increase in volume of the aqueous phase on the CHROMABOND® XTR. Here the column could be overloaded and the aqueous phase displaced from the column. In this case, a greater capacity column should be used.

Depending on the concentration of the analytes eluates can be analyzed immediately, or the organic solvent is evaporated. The pH value of the aqueous solution can be altered on the column, which enables elution of different compounds of a sample under optimized conditions. Under certain circumstances, acidic, neutral, and basic compounds can be fractionated in this way.

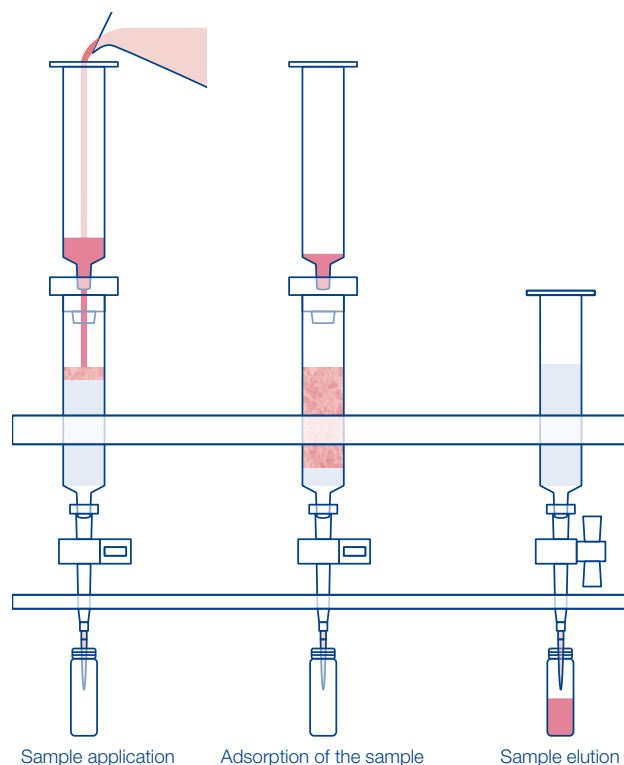

General column parameters

Volume	Adsorbent weight	Max. volume capacity of aq. solution	Waiting period before elution	Elution volume
CHROMABOND® XTR				
1 mL	250 mg	0.25 mL	5 min	3 mL
3 mL	500 mg	0.5 mL	5 min	6 mL
6 mL	1 g	1 mL	5–10 min	8 mL
15 mL	3 g	3 mL	5–10 min	12 mL
30 mL	4.5 g	5 mL	5–10 min	16 mL
45 mL	8.3 g	10 mL	10–15 min	24 mL
70 mL	14.5 g	20 mL	10–15 min	40 mL
150 mL	37.5 g	50 mL	10–15 min	90 mL

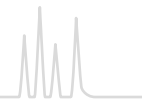

Determination of azo dyes and aromatic amines in colored textile materials with reference to § 64 LFGB (formerly § 35 LMBG)

MN Appl. No. 302100

Column type:

CHROMABOND® XTR, 70 mL, 14.5 g, for max. 20 mL aqueous solution
REF 730507

Sample pretreatment: Weigh about 1 g cut-up textile sample (colored textiles about 0.1 g) in a 100 mL threaded vial. (Degrease leather samples before processing: cover sample with technical purity *n*-hexane and put the vial in an ultrasonic bath for 20 min. After decanting the *n*-hexane rinse with little *n*-hexane and dry sample by gentle heating and blowing with air or N₂).

Add 250 µL internal standard (IS: 1.2 mg/mL tetramethylbenzidine in methanol – ethyl acetate (1:1, v/v)), 17.0 mL citrate buffer (pH 6) (25.05 g citric acid and 12.64 g NaOH, fill up with deionized water to 2 L) and heat 30 min at 70 °C.

Then add 3 mL of a freshly prepared solution of 0.2 g/mL sodium dithionite in water and heat for exactly 30 min to 70 °C while shaking occasionally.

Sample application: Cool the solution immediately (put vial in water – stopping of reductive cleavage). After 5–10 min pour it onto the CHROMABOND® XTR column (squeeze textile remains).

Elution: Allow solution to be soaked up by the adsorbent for 15 min. Then elute four times with 20 mL each of diethyl ether or diethyl ether – ethanol (90:10, v/v) (depending on recovery rates), using the first 40 mL to rinse the sample remains.

Evaporate eluates to 3 mL with a rotation evaporator and transfer the solution into a 10 mL measuring flask using a pasteur pipette and rinsing with methanol. Fill up to the marking with methanol, shake, and pipette about 1 mL into a vial.

Further analysis:

Fast GC on OPTIMA® δ-3, 10 m, 0.1 mm ID, 0.1 µm film, REF 726410.10 (application 210820) or HPLC on NUCLEOSIL® 100-5 C₁₈ HD (application 110500 at www.mn-net.com/apps)

Ordering information

Column volume	1 mL	3 mL	6 mL	15 mL	30 mL	45 mL	70 mL	150 mL
Adsorbent weight	250 mg	500 mg	1 g	3 g	4.5 g	8.3 g	14.5 g	37.5 g
Max. volume capacity of aqueous solution	0.25 mL	0.5 mL	1 mL	3 mL	5 mL	10 mL	20 mL	50 mL
Pack of →	100	50	30	30	30	30	30	10



CHROMABOND® XTR polypropylene columns (glass columns on request)

730501 730502 730487 730489 730505 730506 730507 730509

CHROMABOND® XTR polypropylene columns · BIGpacks

730487.250 (250 col.) 730507.100 (100 col.)

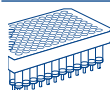

CHROMABOND® MULTI 96 XTR

96-well plates 96 x 150 mg, packs of 1 plate, for max. 96 x 0.2 mL aqueous solution

738131.150M

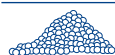

CHROMABOND® XTR adsorbent

50 bags of 14.5 g, (for max. 20 mL aqueous solution each)

for 70 mL PP columns with 100 PE filter elements for NT20 with 50 PE filter elements (10 mm dia.)

730585 730586 500 g 1 kg 5 kg 730595.500 730595.1000 730595.5000

Accessories for liquid-liquid extraction with CHROMABOND® XTR

variable polypropylene rack for 24 positions, incl. 24 PP stopcocks and 24 PP needles

730508

For parallel processing of up to 24 CHROMABOND® XTR columns 1–150 mL we recommend the polypropylene rack REF 730508 consisting of: two side walls, middle part including stopcocks and needles, bottom part, top part for stabilizing 45 mL and 70 mL CHROMABOND® XTR columns.

This rack can be adjusted to various heights depending on the CHROMABOND® XTR columns and the collection vials used.

Each position of the middle part is equipped with a polypropylene stopcock on the top (REF 730185) and a polypropylene needle on the bottom (REF 730154).

For collection of the sample, vessels such as vials, test tubes, round bottom or tapered flasks, can be used. For our program of sample vials, please see the chapter “Vials and accessories” from page 97.

For further applications on CHROMABOND® phases visit our online application database at www.mn-net.com/apps



CHROMABOND® Vacuum manifold

★ Key features

- For the simultaneous preparation of up to 12, 16 or 24 samples
- Replacement parts and accessories for special applications

Vacuum manifold for 12 columns

- ① Rectangular glass cabinet; 2 sizes available: small for up to 12 CHROMABOND® columns or CHROMAFIX® cartridges; large for up to 16 CHROMABOND® LV columns or up to 24 CHROMABOND® columns or CHROMAFIX® cartridges (depending on lid)
- ② Polypropylene lid
- ③ Vacuum gauge for pressure reading
- ④ Control valve for adjustment of vacuum
- ⑤ Replaceable valves for vacuum control of individual SPE columns
- ⑥ Variable rack with exchangeable partitions, which accept a wide variety of vessels like test tubes, measuring flasks, scintillation vials, autosampler vials, plastic vials etc.
- ⑦ CHROMABOND® LV columns with 15 mL sample reservoir for medium size samples
- ⑧ Polypropylene sample reservoirs (30 or 70 mL)*
- ⑨ Adapter for sample reservoirs*
- ⑩ CHROMABOND® tubing adapters

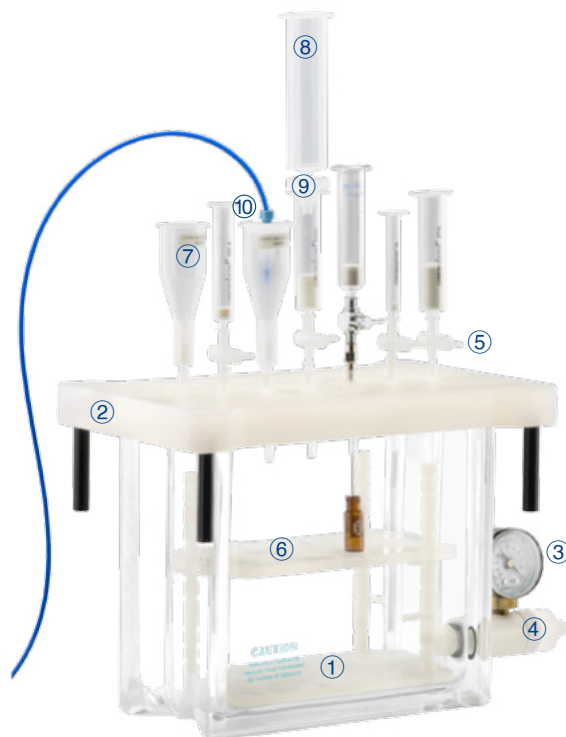

Full description and manual can be downloaded at www.mn-net.com

Ordering information

Description	Pack of	REF
Vacuum manifold complete		
consists of glass cabinet with lid and lid gasket, removable needles on lower side of lid, vacuum gauge, control valve, valves and caps, variable rack:		
for up to 12 columns or cartridges (including PP tank)	1	730150
for up to 16 LV columns	1	730360
for up to 24 columns or cartridges	1	730151
Glass cabinets without accessories ①		
for 12 columns	1	730173
for 16 LV or 24 columns (large)	1	730174
Lids with gaskets ②		
for 12 columns (including Luer fittings and valves ⑤)	1	730175
for 16 LV columns (including Luer fittings and valves ⑤)	1	730365
for 24 columns (including Luer fittings and valves ⑤)	1	730176
Gaskets for lid, for 12 columns	2	730177
Gaskets for lid, for 16 or 24 columns	2	730178

* Ordering information see on page 67.

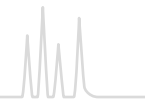

Ordering information

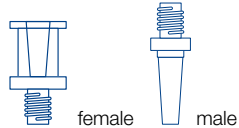
Description	Pack of	REF
General accessories for vacuum manifolds		
Luer stoppers for vacuum manifold, blue	12	730194
Luer fittings for lid, female	12	730183.12
Luer fittings for lid, male	12	730184.12
		
Valves, plastic ⑤	12	730185
Stainless steel needles	12	730152
Polypropylene needles	12	730154
PP tanks for vacuum manifold for 12 columns (not available for 16- or 24-position manifold)	2	730233
Vacuum gauge, complete with accessories ③ + ④	1	730179
Drying attachment and collecting racks		
for evaporation of eluates (application see below)		
Drying attachment, with 12 positions ⑪	1	730187
Drying attachment, with 16 positions	1	730990
Drying attachment, with 24 positions	1	730188
Collecting rack for 12 columns ⑥	1	730157
Collecting rack for 16 LV columns	1	730366
Collecting rack for 24 columns	1	730153
Products for protection from cross contamination		
Valve, brass, tarnished	1	730189.1
Valves, as above	12	730189.12
Stainless steel connectors	12	730106
PTFE connectors	12	730564

⑩ Tubing adapters for application of large sample volumes

for 3 and 6 mL glass columns
 for 1, 3 and 6 mL polypropylene columns
 for 15, 45 and 70 mL polypropylene columns
 (material: PTFE tube length approx. 1 m)

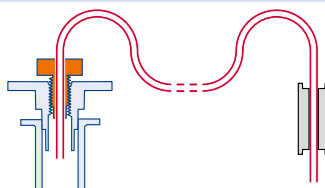

Protection from cross contamination

For special applications which require maximum protection from cross contamination we supply chrome-plated brass valves and stainless steel or PTFE connectors. Their application is shown on the right side. These special connectors are fitted through the lid; thus the sample only has contact with the inert connector and can flow directly into the receptacle.

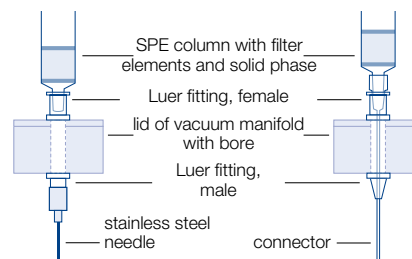

Drying attachment

If the eluate has to be evaporated, this can be performed with the so-called drying attachment ⑪. This special lid has a gas connector ⑫ on one side, from which the gas is fed simultaneously to the 12, 16, or 24 stations ⑬. Thus 12, 16, or 24 eluates can be evaporated simultaneously by just changing the lid and applying a stream of inert gas, e.g., nitrogen.





For individual packing of SPE columns with CHROMABOND® adsorbents

Ordering information		
Description	Pack of	REF
Empty polypropylene columns with 2 PE filter elements, 1 mL	100	730159
Empty polypropylene columns with 2 PE filter elements, 3 mL	50	730160
Empty polypropylene columns with 2 PE filter elements, 6 mL	30	730161
Empty polypropylene columns with 2 PE filter elements, 15 mL	20	730230
Empty polypropylene columns with 2 PE filter elements, 30 mL	20	730380
Empty polypropylene columns with 2 PE filter elements, 45 mL	20	730355
Empty polypropylene columns with 2 PE filter elements, 70 mL	20	730158
Empty polypropylene columns with 2 PE filter elements, 150 mL	20	730474
PE filter elements for polypropylene columns 1 mL	250	730164
PE filter elements for polypropylene columns 3 mL	250	730162
PE filter elements for polypropylene columns 6 mL	250	730163
PE filter elements for polypropylene columns 15 mL	250	730351
PE filter elements for polypropylene columns 30 mL	250	730034
PE filter elements for polypropylene columns 45 mL	250	730356
PE filter elements for polypropylene columns 70 mL	250	730026
PE filter elements for polypropylene columns 150 mL	250	730475
Empty glass columns with 2 glass fiber filter elements, 3 mL	50	730171
Empty glass columns with 2 glass fiber filter elements, 6 mL	30	730172
Glass fiber filter elements for glass columns 3 mL	250	730191
Glass fiber filter elements for glass columns 6 mL	250	730192
Empty LV polypropylene columns with PE filter elements, 15 mL, for 100 mg adsorbent weight	50	732500
Empty LV polypropylene columns with PE filter elements, 15 mL, for 200/500 mg adsorbent weight	50	732501
PE filter elements for LV polypropylene columns 15 mL for 100 mg adsorbent weight	250	732019
PE filter elements for LV polypropylene columns 15 mL for 200/500 mg adsorbent weight	250	732020
Adapters (PVDF) for glass columns	4	730104.4
Adapters as above	10	730105
Adapters (PP) for polypropylene columns (1, 3 and 6 mL)	4	730100.4
Adapters as above	10	730101
Adapters (PE) for polypropylene columns (15, 45, 70 mL)	4	730350.4
Adapters as above	10	730385
Adapter (PE) for polypropylene columns (30 and 70 mL)	1	730566
Reservoir columns for application of medium-size samples ⑧ + ⑨		
Reservoir column 30 mL, polypropylene, with one adapter for 1, 3, 6 mL CHROMABOND® polypropylene columns	1	730102
10 Reservoir columns 30 mL, polypropylene, with one adapter for 1, 3, 6 mL CHROMABOND® polypropylene columns	1 kit	730103
Reservoir column 70 mL, polypropylene, with one adapter for 1, 3, 6 mL CHROMABOND® polypropylene columns	1	730381
10 Reservoir columns 70 mL, polypropylene, with one adapter for 1, 3, 6 mL CHROMABOND® polypropylene columns	1 kit	730382
Reservoir column 70 mL, polypropylene, with one adapter for 15, 45, 70 mL CHROMABOND® polypropylene columns	1	730388
10 Reservoir columns 70 mL, polypropylene, with one adapter for 15, 45, 70 mL CHROMABOND® polypropylene columns	1 kit	730389

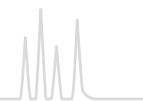

Automated and on-line SPE

Performing Solid Phase Extraction (SPE) manually can be time consuming and nerve-racking, especially when recovery and reproducibility are lacking due to sample variability. If SPE can be reliably automated it becomes a much more efficient and reproducible process.

On-line SPE is a powerful method in automated sample preparation where the SPE hardware is technically integrated into a HPLC system. Crude samples are placed in an autosampler and processed fully automatically prior to injection into a GC (MS) or LC (MS) system.

MN offers different on-line column configurations designed to fit your on-line SPE needs and filled with a choice of different adsorbents, modifications and particle sizes:

- Ready-to-use EC columns or ChromCart® cartridges for on-line SPE (standard dimensions 20 x 2 mm or 20 x 4 mm, resp.), filled with CHROMABOND® HR-Xpert phases (15 µm particles) or with NUCLEODUR® C₁₈ ec, C₈ ec, CN (20 µm particles)



EC column



CC-cartridges

- Columns for Gilson® ASPEC™ systems are ready to use assembled with caps. In addition to the columns and phases listed below, all 1, 3 and 6 mL CHROMABOND® polypropylene columns from our program can be supplied assembled with ASP caps.



Columns for the Gilson® ASPEC™

Ordering information Gilson® ASPEC™ columns

Volume	Adsorbent weight	Pack of [columns]	REF
CHROMABOND® SiOH			
1 mL	100 mg	100	730071ASP
3 mL	500 mg	100	730073ASP
6 mL	1000 mg	100	730075ASP
CHROMABOND® C₁₈ ec			
1 mL	100 mg	100	730011ASP
3 mL	500 mg	100	730013ASP
6 mL	1000 mg	100	730015ASP

- SPE columns equipped with caps and needles to be used in the SPE unit of the Gerstel MultiPurposeSampler (MPS)



SPE cartridges for Gerstel MPS system



Gerstel MPS system

Ordering information Gerstel MPS columns

Volume	Adsorbent weight	Pack of [columns]	REF
CHROMABOND® SiOH			
3 mL	200 mg	50	730214MPS
3 mL	500 mg	50	730073MPS
6 mL	1000 mg	30	730075MPS
CHROMABOND® C₁₈ ec			
1 mL	100 mg	100	730011MPS
3 mL	200 mg	50	730012MPS
3 mL	500 mg	50	730013MPS
CHROMABOND® HR-X			
1 mL	100 mg	30	730935MPS
3 mL	200 mg	30	730931MPS
6 mL	500 mg	30	730939MPS

Other dimensions and adsorbents on request.

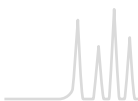

CHROMABOND® MULTI 96 for robot systems

Alternatively CHROMABOND® MULTI 96 plates provide a means of high throughput sample preparation by processing 96 samples in a standard 8 x 12 microcolumn plate format compatible with standard 96-well plate liquid handling technologies and injection systems. MULTI 96 plates are available for solid phase extraction (SPE) and for filtration (see page 95)

CHROMABOND® MULTI 96

- 96-well PP microtiter plates with PE filter elements
- Cavity volume 1.5 mL
- Adsorbent weights 10, 25, 50, 100 mg per microcolumn
- Supplied with any CHROMABOND® SPE adsorbents
- For the simultaneous preparation of 96 samples
- Easy method transfer from CHROMABOND® columns or CHROMAFIX® cartridges to CHROMABOND® MULTI 96

Advantages of this high-throughput system

- Simultaneous preparation of 96 samples; this means a 4-fold increase over traditional 24-position SPE processors
- Economical by saving time and solvent
- Use of multi-channel pipettors facilitates liquid transfer steps
- Readily adaptable to all common automated and robotic handling systems
- Minimized dead volume ($\leq 40 \mu\text{L}$)

Instrument compatibility

CHROMABOND® MULTI 96 SPE microtiter plates as well as CHROMAFIL® MULTI 96 filtration plates are compatible with, e.g., the following liquid handling and SPE automation systems:

- Perkin Elmer MultiProbe® II
- Tomtec Quadra 3® and Quadra 3® SPE
- Hamilton Microlab® SPE Workstation
- Beckman Coulter Biomek® 2000
- Caliper Life Science RapidTrace®
- Gilson® ASPEC™ XL4 and ASPEC™ XL
- Gilson® 215 SPE Liquid Handler
- Tecan Genesis™ FE500
- Eppendorf epMotion®

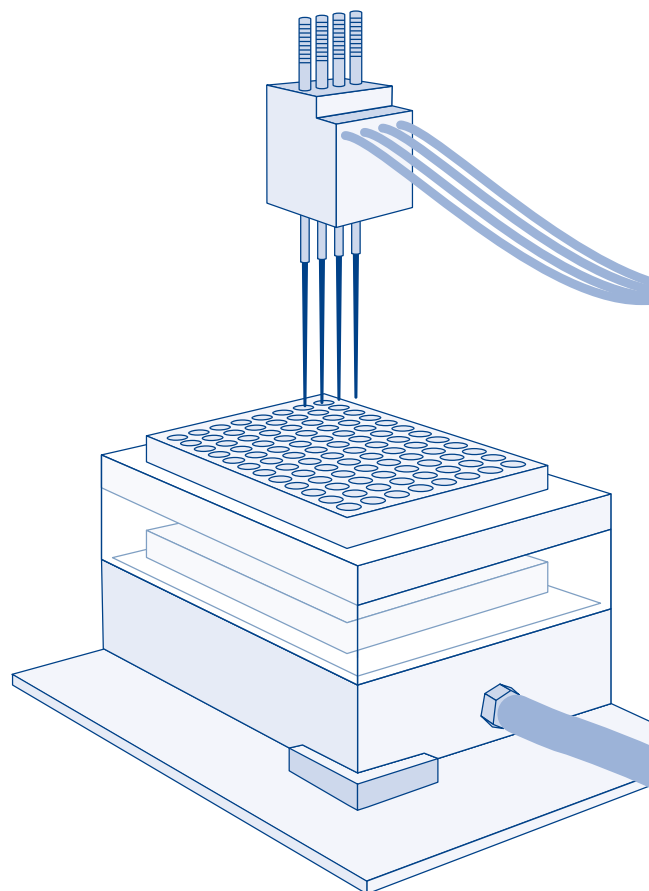



CHROMABOND® MULTI 96 vacuum manifold

For handling of CHROMABOND® MULTI 96 SPE plates for up to 96 samples

CHROMABOND® MULTI 96 is designed for use in common robotic workstations or commercially available liquid handling systems. Alternatively, use of multichannel pipettors facilitates a manual liquid transfer. Extraction is carried out using the CHROMABOND® MULTI 96 vacuum manifold.

With the help of the control valve the vacuum of the manifold can be adjusted leading to an optimum flow rate through the CHROMABOND® MULTI 96 SPE plate.

A reservoir tank and 96-well collection plates (96 x 0.5 or 96 x 2 mL) made of polypropylene can be supplied as accessories.

An interesting alternative for collection of the eluates is a collection rack, which can be fitted with twelve 8-well strips of polypropylene tubes (each 1 mL).

If you have to work on less than 96 samples, you can seal individual rows of the 96-well plate with a PTFE-covered rubber pad.

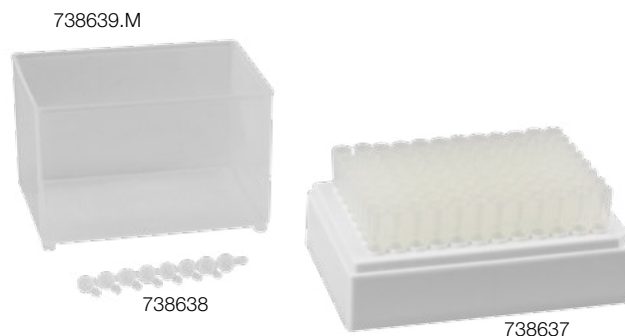

Ordering information

Description	Pack of	REF
CHROMABOND® MULTI 96 accessories		
CHROMABOND® MULTI 96 vacuum manifold with reservoir tank, vacuum gauge, and control valve	1	738630.M
96-well microtiter plates (polypropylene) 96 x 0.25 mL	10	738651
96-deep-well collecting plate (polypropylene) 96 x 2 mL	5	738650.5
Collection racks with polypropylene tube strips (twelve 8-well strips) 96 x 1.0 mL	5	738637
Polypropylene tube strips (twelve 8-well strips) 96 x 1.0 mL	10	738652
8-well strip sealing caps for PP tube strips (REF 738652)	30	738638
Reservoir tanks (polypropylene)	2	738639.M
Butyl rubber pad, PTFE covered for sealing of individual rows of the 96-well plate, 125 x 85 mm	1	738645

For CHROMAFIL® MULTI 96 filter plates see page 95. The ordering information of 96-well plates packed with individual CHROMABOND® adsorbents is listed with the respective phases.



MN Flash adsorbents a unique variety of phases

★ Key features

- Flash columns and cartridges from MACHEREY-NAGEL are available with all CHROMABOND® SPE / Flash packings (more than 40 phases, e.g., C₁₈, C₈, OH, Alox). Additionally you can choose from our range of POLYGOPREP silica packings in particle sizes from 20 to 130 µm and pore sizes from 60 to 4000 Å.
- For high performance Flash separations spherical silica featuring very high separation efficiency can be requested

🔧 Technical characteristics

- Specification of modified and plain silica, acid-washed irregular silica, pore size 60 Å, particle size 45 µm, specific surface 500 m²/g, pH stability 2–8



Comparison of separation efficiency and price of irregular versus spherical silica

Separation efficiency and reproducibility

Our optimized automatic packing process leads to an excellent packing quality, irrespective of the phase or particle size distribution (normal phase or reversed phase, spherical or irregular particles). MACHEREY-NAGEL, as a manufacturer of silicas, has decades of experience in the production of first class separation phases and columns. This leads to highest separation efficiencies of the columns, a constant back pressure (via controlled narrow particle size distribution) and good reproducibilities from cartridge to cartridge.

The separation efficiency is in the first place not influenced by the dimension or the geometry of the Flash RS cartridges. The chromatograms below show an identical resolution and peak form for different column dimensions, when flow and sample amount is adjusted correctly. This is advantageous for optimization and upscaling experiments.

Resolution and peak shape for different column dimensions

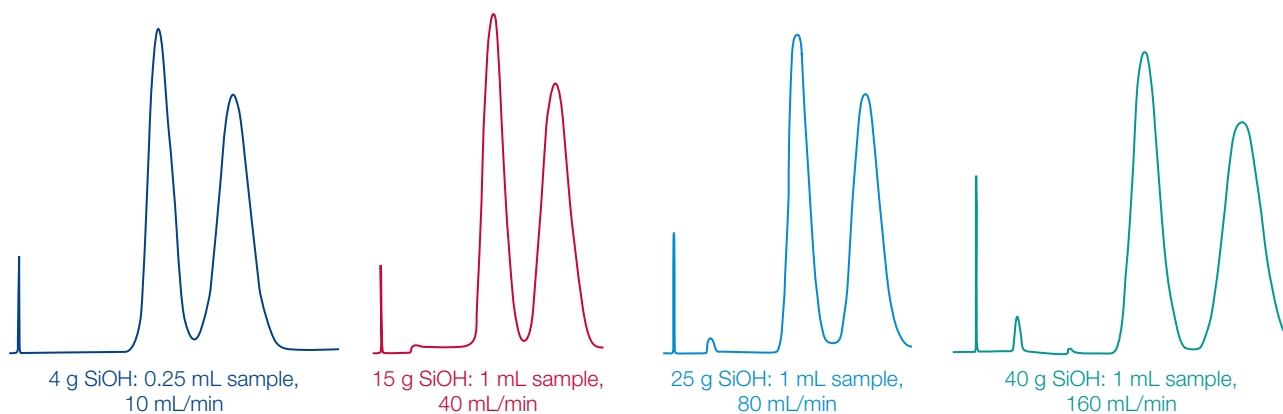



MN TLC and Flash products

- Same selectivity and easy upscaling from TLC to Flash separations
- Saving time and money, because expensive optimizations are not required

TLC is often used for the development of a selective and reproducible method in Flash chromatography, because it is often necessary to test a large number of eluent and / or adsorbent

TLC screening

For TLC separation you should start with an unmodified silica and a nonpolar eluent of low viscosity (e.g., mixtures of *n*-hexane – ethyl acetate or *n*-hexane – acetone). By changing the composition of the eluent the R_f value of the TLC separation is adjusted to approx. 0.3. Increasing polarity of the eluent decreases the R_f

combinations. MN TLC plates and sheets are coated with the same base silica, which is used in our CHROMABOND® Flash cartridges. This is an important prerequisite for the reproducible transfer of a TLC separation to the Flash column, because the parameters are identical in both systems.

values. The difference in R_f values between the substances to be separated should be at least 0.1 to allow a reliable separation in the subsequent flash chromatography. Variation of the eluent components (e.g., acetone, dichloromethane) can be used to enhance the separation by eluent specific selectivity.

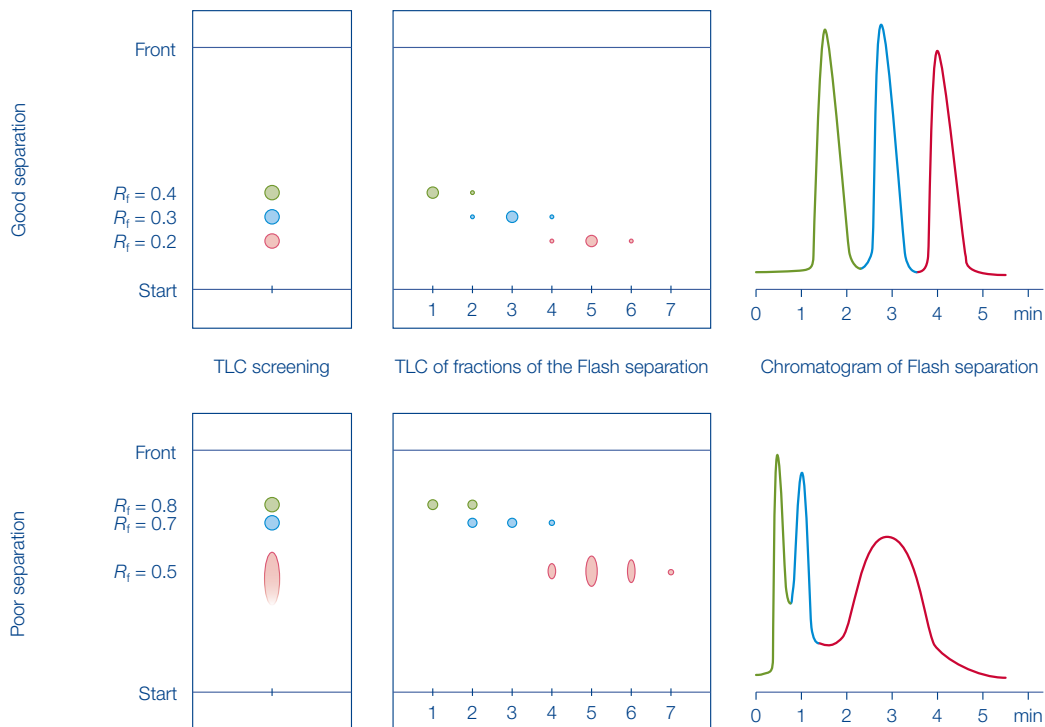

Our program of TLC plates can be found from page 273 onwards.

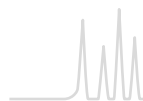

Technical support for Flash RS and Flash BT

Loadability

- Due to the narrow particle size distribution, the excellent packing quality and the optimized stationary phases (acid washed silica, reduced particulate matter) our cartridges can realize highest loadability at best possible separation efficiency.
- Additionally, the large range of different cartridge lengths and diameters eases to find the optimum in loadability for a given sample amount.

Rule of thumb for the loadability

Separation	Loadability	g sample / g adsorbent
difficult	low	≤ 1 %
easy	high	≥ 10 %

Loadability table CHROMABOND® Flash RS and BT

SiOH cartridge	Average loadability per cartridge [g]	
	difficult separation	easy separation
RS/BT 4	0.04	0.4
RS/BT 15	0.15	1.5
RS/BT 25	0.25	2.5
RS/BT 40	0.4	4
RS/BT 80	0.8	8
RS/BT 120	1.2	12
RS/BT 200	2	20
RS/BT 330	3.3	33
RS 800	8	80
RS 1600	16	160

Back pressure and pressure stability

The back pressure always depends on flow rate and viscosity of the eluent mixture, column length and diameter and the particle size. The high performance CHROMABOND® Flash RS cartridges up to 200 g silica are stable up to 15 bar (220 psi, > 200 g: 12 bar).

Back pressure of CHROMABOND® Flash RS SiOH cartridges (eluent hexane – ethyl acetate 9:1 or 8:2)

Flow rate	20 mL/min	40 mL/min	80 mL/min	120 mL/min	160 mL/min	200 mL/min	240 mL/min
Cartridge							
RS/BT 4	0.75 bar	1.5 bar					
RS/BT 15	0.25 bar	0.75 bar	1.5 bar	2.0 bar			
RS/BT 25	0.5 bar	1.0 bar	1.75 bar	3.0 bar	4.0 bar	5.0 bar	
RS/BT 40		0.75 bar	1.5 bar	2.25 bar	3.0 bar	3.25 bar	3.5 bar
RS/BT 80			1.5 bar	2.5 bar	3.0 bar	3.5 bar	4.0 bar
RS/BT 120			1.0 bar	1.5 bar	2.0 bar	2.5 bar	3.0 bar
RS/BT 200			1.0 bar	1.5 bar	2.0 bar	2.5 bar	3.0 bar
RS/BT 330	(typical flow rate)		1.5 bar	2.25 bar	3.0 bar	3.5 bar	4.0 bar

Conditioning volumes for CHROMABOND® Flash RS cartridges (normally 1.5 column volumes of the eluent)

Cartridge	Volume of eluent for conditioning
RS/BT 4	20 mL
RS/BT 15	60 mL
RS/BT 25	90 mL
RS/BT 40	140 mL
RS/BT 80	280 mL

Upscaling of the optimum flow rate

This depends on the eluent, the separation problem, the amount of adsorbent and also on the dimensions of the column.

In the simplest case the upscaling relation is proportional to the amount of adsorbent (for equal eluent polarity).

For the flow rate the following would apply e.g.,

4 g silica → optimum flow: ~ 6–12 mL/min

40 g silica → optimum flow: ~ 60–120 mL/min

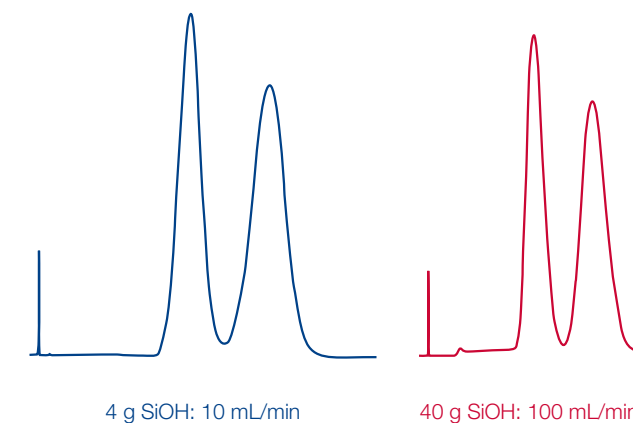

Upscaling of the flow rate

We recommend using a pressure guard, because short time pressure peaks (viscosity of eluent or gradient changes) can exceed the pressure limit.



CHROMABOND® Flash cartridges

Ideal for Flash separations from 10 mg up to 160 g

Convenient operation and reliable upscaling; Complete program of ready-to-use Flash cartridges for:

- Isco Companion® and other Teledyne Isco CombiFlash® systems
- Biotage® Isolera™, Biotage® FlashMaster™
- Or as stand-alone version for all pump / detector combinations, e.g., from Biotage®, Büchi

Enhanced flexibility

- All common RP and NP phases available on request
- Adsorbent weights from 4 g to 1600 g (up to 300 g for BT)

Outstanding price-performance ratio

Increased analytical safety

- Low bleed polypropylene cartridges, organic solvent resistant, thick column walls, one piece body, sophisticated length-to-diameter ratio for high plate numbers and excellent separation efficiencies, optimal ratio of length and diameter
- Distribution of eluent stream via highly porous frits
- High pressure stability of 21 bar / 300 psi (15 bar for 80 g and 120 g cartridges, 12 bar for cartridges > 200 g, 7 bar for 3000 g), good reproducibility

High quality standard

- All flash cartridges and adsorbents undergo comprehensive during- and after-production quality assurance measures to ensure that the products conform to the specification.



CHROMABOND® Flash RS - pictures of CHROMABOND® Flash BT, DL and FM hardware can be found on page 15.



CHROMABOND® Flash RS solutions for Isco® Flash instruments

★ Key features

- Heavy-duty polypropylene cartridges designed for use in Teledyne Isco CombiFlash® systems (Companion®, R_f etc.) without additional connectors or capillaries.
- Column connection:
cartridges up to RS 330: female Luer lock inlet and male Luer outlet
RS 800 and RS 1600: maxi Luers

✓ Recommended application

- Using the CHROMABOND® Flash Starter Kit, REF 730798 or the CHROMABOND® Flash Stand Alone Kit, REF 732903 (see page 78) CHROMABOND® Flash RS cartridges can also be used as stand alone system with any pump / detector / fraction collector combination (except RS 800, RS 1600 and RS 3000 with maxi Luers).

Ordering information

Description	Column length [cm]	ID [mm]	Adsorbent weight [g]	Pack of	REF
CHROMABOND® Flash RS columns with Luer exit					
Filled with standard silica, unmodified (SiOH) or endcapped octadecyl modified (C ₁₈ ec), 40–63 µm, specific surface 500 m ² /g, pH stability 2–8					
CHROMABOND® Flash RS 4 SiOH	9.8	12.4	4	20	732800
CHROMABOND® Flash RS 15 SiOH	11.6	21.2	15	20	732801
CHROMABOND® Flash RS 25 SiOH	16.5	21.2	25	15	732802
CHROMABOND® Flash RS 40 SiOH	17.1	26.4	40	15	732803
CHROMABOND® Flash RS 80 SiOH	24.0	30.8	80	12	732804
CHROMABOND® Flash RS 120 SiOH	25.5	36.0	120	10	732805
CHROMABOND® Flash RS 200 SiOH	20.0	60.0	200	6	732806
CHROMABOND® Flash RS 330 SiOH	27.0	60.0	330	4	732807
CHROMABOND® Flash RS 800 SiOH	38.5	82.0	800	2	732808
CHROMABOND® Flash RS 1600 SiOH	43.0	104.0	1600	2	732809
CHROMABOND® Flash RS 3000 SiOH	51.0	127.5	3000	1	732850
Corresponding TLC plates: silica (see page 273)					
CHROMABOND® Flash RS 4 C ₁₈ ec	9.8	12.4	4.3	2	732810
CHROMABOND® Flash RS 15 C ₁₈ ec	11.6	21.2	16.4	1	732811
CHROMABOND® Flash RS 25 C ₁₈ ec	16.5	21.2	26	1	732812
CHROMABOND® Flash RS 40 C ₁₈ ec	17.1	26.4	43	1	732813
CHROMABOND® Flash RS 80 C ₁₈ ec	24.0	30.8	86	1	732814
CHROMABOND® Flash RS 120 C ₁₈ ec	25.5	36.0	130	1	732815
CHROMABOND® Flash RS 200 C ₁₈ ec	20.0	60.0	220	1	732816
CHROMABOND® Flash RS 330 C ₁₈ ec	27.0	60.0	360	1	732817
CHROMABOND® Flash RS 800 C ₁₈ ec	38.5	82.0	880	1	732818
CHROMABOND® Flash RS 1600 C ₁₈ ec	43.0	104.0	1760	1	732819
Corresponding TLC plates: RP-18 W/UV ₂₅₄ (see page 284)					

On request, all column types listed above can be packed with any adsorbent from our program of CHROMABOND® adsorbents (starting from page 16). Please note that other packings often result in differing adsorbent weights.



CHROMABOND® Flash BT solutions for Biotage® Flash instruments

★ Key features

- Heavy-duty polypropylene cartridges designed for use in the Biotage® Isolera™ systems without additional connectors or capillaries.
- Column connection:
female Luer lock inlet and male Luer lock outlet

✓ Recommended application

- Using the CHROMABOND® Flash Starter Kit, REF 730798 or the CHROMABOND® Flash Stand Alone Kit, REF 732903 (see page 78) CHROMABOND® Flash BT cartridges can also be used as stand alone system with any pump / detector / fraction collector combination.

Ordering information

Description	Column length [cm]	ID [mm]	Adsorbent weight [g]	Pack of	REF
CHROMABOND® Flash BT columns with Luer lock exit					
Filled with unmodified standard silica, 40–63 µm, specific surface 500 m ² /g, pH stability 2–8					
CHROMABOND® Flash BT 4 SiOH	9.8	12.4	4	20	732960
CHROMABOND® Flash BT 15 SiOH	11.6	21.2	15	20	732961
CHROMABOND® Flash BT 25 SiOH	16.5	21.2	25	15	732962
CHROMABOND® Flash BT 40 SiOH	17.1	26.4	40	15	732963
CHROMABOND® Flash BT 80 SiOH	24.0	30.8	80	12	732964
CHROMABOND® Flash BT 120 SiOH	25.5	36.0	120	10	732965
CHROMABOND® Flash BT 200 SiOH	20.0	60.0	200	6	732966
CHROMABOND® Flash BT 330 SiOH	27.0	60.0	330	4	732967

On request, all column types listed above can be packed with any adsorbent from our program of CHROMABOND® adsorbents (starting from page 16). Please note that other packings often result in differing adsorbent weights.

Partly filled CHROMABOND® Flash BT cartridges (e.g., filled up to 80 %) are available on request. By removal of the top cap the sample can be applied directly on to the cartridges (see page 77).

CHROMABOND® Flash DL cartridges solutions for direct loading

★ Key features

- Column connection:
female Luer lock inlet and male Luer lock outlet.
Each cartridge comes with 3 filter elements: one already inserted, two more filters aside.
- Suitable as solid injection system
- For individual self-filling and packing of flash cartridges

Ordering information

Description	Column length [cm]	ID [mm]	For adsorbent weight [g]		Volume [mL]	Empty column Pack of	REF	PE filter elements	
			SiOH	Kieselguhr				Pack of	REF
CHROMABOND® Flash DL empty cartridges									
CHROMABOND® Flash DL 4	9.8	12.4	4	3	8	50	732980	250	732980FE
CHROMABOND® Flash DL 15	11.6	21.2	15	10	30	50	732981	250	732981FE
CHROMABOND® Flash DL 25	16.5	21.2	25	15	45	50	732982	250	732982FE
CHROMABOND® Flash DL 40	17.1	26.4	40	30	75	20	732983	250	732983FE
CHROMABOND® Flash DL 80	24.0	30.8	80	60	160	20	732984	250	732984FE
CHROMABOND® Flash DL 120	25.5	36.0	120	80	220	20	732985	250	732985FE
CHROMABOND® Flash DL 200	20.0	60.0	200	150	410	10	732986	100	732986FE
CHROMABOND® Flash DL 330	27.0	60.0	330	250	600	10	732987	100	732987FE



- ① CHROMABOND® Flash DL cartridge filled with sample on CHROMABOND® XTR on top of CHROMABOND® Flash RS or BT silica cartridge
- ② CHROMABOND® Flash BT cartridge partly filled with silica topped with sample on CHROMABOND® XTR

Options for solid injection

The sample is dissolved in a suitable solvent and adsorbed onto CHROMABOND® XTR (diatomaceous earth, see page 63). After removal / evaporation of the residual solvent, the adsorbent

is put on top of a partly filled CHROMABOND® Flash BT cartridge or into an empty CHROMABOND® Flash DL cartridge.

Our XTR adsorbents can be found on page 63.

CHROMABOND® Flash FM solutions for FlashMaster™ instruments

★ Key features

- Column connection: open-tubular inlet and male Luer outlet

✓ Recommended application

- Polypropylene cartridges designed for use in the Biotage® FlashMaster™ systems without additional connectors or capillaries

Ordering information

Description	Column length [cm]	ID [mm]	Adsorbent weight [g]	Pack of	REF
CHROMABOND® Flash FM columns					
Filled with standard silica, unmodified (SiOH) or endcapped octadecyl modified (C ₁₈ ec), 40–63 µm, specific surface 500 m ² /g, pH stability 2–8					
CHROMABOND® Flash FM 15/2 SiOH	9.0	15.8	2.0	50	730881
CHROMABOND® Flash FM 25/5 SiOH	10.0	20.5	5.0	50	730891
CHROMABOND® Flash FM 25/10 SiOH	10.0	20.5	10.0	50	730666
CHROMABOND® Flash FM 70/10 SiOH	15.4	26.8	10.0	30	730885
CHROMABOND® Flash FM 70/20 SiOH	15.4	26.8	20.0	30	730915
CHROMABOND® Flash FM 70/25 SiOH	15.4	26.8	25.0	30	730892
CHROMABOND® Flash FM 150/25 SiOH	17.0	38.2	25.0	20	730667
CHROMABOND® Flash FM 150/50 SiOH	17.0	38.2	50.0	20	730887
CHROMABOND® Flash FM 150/70 SiOH	17.0	38.2	70.0	10	730880
CHROMABOND® Flash FM 15/2 C ₁₈ ec	9.0	15.8	2.0	50	730890
CHROMABOND® Flash FM 25/5 C ₁₈ ec	10.0	20.5	5.0	20	730884
CHROMABOND® Flash FM 70/10 C ₁₈ ec	15.4	26.8	10.0	20	730886
CHROMABOND® Flash FM 150/50 C ₁₈ ec	17.0	38.2	50.0	10	730888

On request, all column types listed above can be packed with any adsorbent from our program of CHROMABOND® adsorbents (starting from page 16). Please note that other packings often result in differing adsorbent weights.

Custom filling sizes are available on request.



CHROMABOND® Flash connecting kits



CHROMABOND® Flash connecting kits allow to use CHROMABOND® Flash RS and BT cartridges as stand-alone system with any pump, detection, fraction collector combination.



Female Luer lock for column inlet



Male Luer lock for column exit

REF 730798 CHROMABOND® Flash Starter Kit

REF 732903 CHROMABOND® Flash Stand Alone Kit, Luer

Ordering information

Description	Pack of	REF
CHROMABOND® Flash Starterkit consists of 1/8" PTFE tubing, 1.5 mm ID, 3 m long; 5 x 1/4"-28 PP nuts; 5 x 1/8" ETFE ferrules; 5 x 1/4"-28 nylon unions; 2 x 1/4"-28 PP Luer lock, female; 1 x 1/4"-28 PP Luer lock, male; 1 x 1/4"-28 PP Luer tip, male	1 Kit	730798
CHROMABOND® Flash "Stand Alone" Kit, Luer consists of 1 x 1/4"-28 PP Luer lock, female; 1 x 1/4"-28 PP Luer lock, male; 2 x 1/8" ETFE ferrules; 2 x 1/4"-28 nylon unions; 2 x 1/4"-28 PP nuts	1 Kit	732903



Glass columns and accessories for Flash chromatography

★ Key features

- MN flash chromatography kits include a glass column, eluent reservoir, silica 60 and accessories. Glass columns of different sizes and accessories can be ordered separately.
- These columns are normally filled to a height of about 15 cm, working pressures are 1.5 to 2 bar.
- The most used adsorbent is silica 60 with particle size 40–63 µm (see page 259), however, you may also use our ranges of other LC adsorbents and of POLYGOPREP silica phases (see page 258). Particle sizes < 25 µm should only be used with very low-viscosity mobile phases, because otherwise flow rates will be very low.
- These columns are packed by the user.
- No expensive equipment required

✓ Recommended application

- Economic low-tech method for the synthesis laboratory
- Suited for the separation of compounds up to gram levels

Ordering information

Description	Pack of	REF
Flash chromatography kits		
Flash chromatography kit I consists of 1 glass column 20 mm ID x 400 mm length, one 1-L eluent reservoir, 100 g silica 60 (40–63 µm), sea sand, silanized glass fiber wadding, 1 m PTFE tubing	1 kit	727450
Flash chromatography kit II consists of 1 glass column 40 mm ID x 450 mm length, one 2-L eluent reservoir, 100 g silica 60 (40–63 µm), sea sand, silanized glass fiber wadding, 1 m PTFE tubing	1 kit	727451
Flash chromatography glass columns		
complete with adapter and PTFE tap, fitted with a polyethylene net to protect against bursting		
20 mm ID x 200 mm length	1 column	727400
20 mm ID x 400 mm length	1 column	727401
25 mm ID x 200 mm length	1 column	727402
25 mm ID x 400 mm length	1 column	727403
30 mm ID x 300 mm length	1 column	727404
30 mm ID x 400 mm length	1 column	727405
40 mm ID x 300 mm length	1 column	727406
40 mm ID x 450 mm length	1 column	727407
Accessories for flash chromatography glass columns		
1-L eluent reservoir with adapter, covered with a protective plastic sleeve for burst protection; this also prevents build-up of UV-induced radicals in the eluent	1 piece	727420
2-L eluent reservoir as above	1 piece	727421
Pressure gauge for controlling flow rates	1 piece	727422
PTFE tubing, 3 mm OD, 2 mm ID, length 1 m	1 m	727424
Sea sand, acid washed and calcined	1 kg	727423
Glass fiber wadding, silanized	25 g	718002

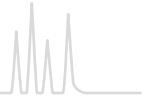

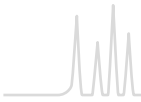

Contents

Basics.....	82
Selection guide for syringe filters.....	84
CHROMAFIL® combi filters.....	85
CHROMAFIL® syringe filters.....	86
Chemical compatibility of CHROMAFIL®.....	93
CHROMAFIL® filtration cartridges · MULTI 96.....	94

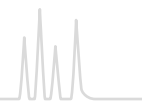

Sample filtration

Syringe filters are used for filtration of suspended matter from liquid samples or gases. With CHROMAFIL® rapid purification and removal of particles is very simple: just place the filter on the syringe and you are ready for filtration. Special manipulations are not required. The contamination of sensitive instrumentation by solid impurities can be avoided, which leads to an increase of lifetime of chromatographic columns and equipment.

Advantages

Polypropylene housing

- Considerably better solvent stability compared to acrylate and polystyrene filters, featuring a low content of extractable substances

Lowest content of extractable substances

- The housing of every CHROMAFIL® filter is ultrasonically sealed (welded), not glued, because glue may have extractable ingredients. Welding leads to a tight connection between both parts, thus the filter can be used in both directions. The special thick rim of the housing is ideal for use in laboratory robots (e.g., SOTAX®, Benchmate™).

Luer lock on the side of entry

- For a safe connection on the high-pressure side every filter provides a Luer lock on the side of entry.

Luer exit

- For 3, 13 and 25 mm filters: standard Luer exit
- For 15 mm filters: minispike · This Luer configuration offers a low hold-up volume and easy filtration into autosampler vials and NMR tubes.
- With the aid of a special adapter, filter inlet and filter exit can be fitted to all CHROMABOND® columns and accessories for selective sample preparation.

No rupture of membrane due to the impact plate

- The input solvent stream is broken and distributed by the impact plate and does not directly hit the membrane: this prevents rupture of the membrane. The high pressure stream is diverted into four lanes.

Optimum flow geometry because of the starshaped distribution device

- The stream of liquid is broken into 4 lanes by the impact plate and then further distributed to 8 slots in the form of a star connected with 5 or 8 circular channels (for 13, 15 and 25 mm filters, respectively). Thus, the fluid is able to penetrate the membrane on the whole surface, not only on a small region; the filter is not plugged up rapidly, which results in a high-flow efficiency.

Color coded filters

- Filters with 0.2 µm pores have a yellow upper shell, that of filters with 0.45 µm pores is colorless; the different membrane types are distinguished by different colors of the lower shell.

Different pore sizes for versatile filtration

- Standard pore sizes 0.2 and 0.45 µm (additionally: PET filters with 1.2 µm, glass fiber filters with 1 µm, PES filters with 5 µm). Filters with 0.45 µm pore size efficiently remove fine particles that can plug chromatography columns. Filters with 0.2 µm pore size are excellent for filtration of UHPLC samples or other techniques requiring high purity samples.

Filter sizes

- 3, 13, 15 and 25 mm diameter: the small diameter filters are especially recommended for very small samples, which require extremely low dead volumes: 5 µL for 3 mm Ø, 30 µL for 13 mm Ø, 35 µL for 15 mm Ø, 80 µL for 25 mm Ø

Recommended filter size depending on sample volume

Sample volume	Recommended filter diameter
≤ 1 mL	3 mm
1–5 mL	13 mm, 15 mm
5–100 mL	25 mm

Filters can be autoclaved at 121 °C, 1.1 bar for 30 min.

All 25 mm CHROMAFIL® filters are designed to be 100 % compatible and reliable for use with the SOTAX® AT70 smart fully automated dissolution testing systems.



Depending on your filtration task you can choose filter membranes made from different materials:

Material	Page
Combi filters with glass fiber prefilters	
Polyester (GF/PET)	85
Regenerated cellulose (GF/RC)	85
Polyvinylidene difluoride (GF/PVDF)	85
Syringe filters without prefilters	
Polyester (PET)	86
Regenerated cellulose (RC)	87
Polytetrafluoroethylene (PTFE)	88
Hydrophilized polytetrafluoroethylene (H-PTFE)	88
Cellulose mixed esters (MV)	89
Cellulose acetate (CA) · sterile and non-sterile	89
Polyamide / Nylon (PA)	90
Polyethersulfone (PES)	90
Polyvinylidene difluoride (PVDF)	91
Glass fiber (GF)	91
Special filter for ion chromatography (IC)	92

CHROMAFIL® BIGbox

- 400 color-coded quality syringe filters or 400 labeled Xtra syringe filters (25 mm)
- Food safe PE box with screw cap

CHROMAFIL® Xtra

Labeled for method validation and certification

- Xtra: imprint for direct identification of the membrane type, diameter and pore size
- Xtra: low bleeding PP housing
- Xtra: color-free plain polypropylene



CHROMAFIL® combi filters

Combi syringe filters with a coarse glass fiber prefilter and a small pore membrane as main filter

User benefits:

- For solutions with a high load of particulate matter: lower back pressure, easy filtration
- For high yields of filtrate: more mL of pure filtrate per filter

The technology

The glass fiber membrane (1.0 µm) removes coarse particles, before they can block the fine main membrane. This results in a better filtration efficiency, especially for highly contaminated samples.

- Housing: Solvent-resistant, ultra low bleeding polypropylene
- Inlet: Luer lock
- Exit: Luer
- Pore size: 1.0/0.20 µm or 1.0/0.45 µm
- Filter diameter: 25 mm
- Dead volume: < 80 µL
- Packing unit: 100 filters; BIGbox with 400 filters

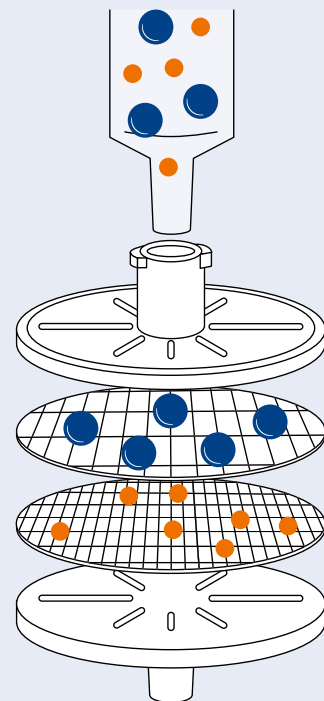



Selection guide for syringe filters

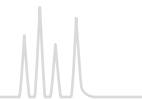

How to select the optimal CHROMAFIL® syringe filter

1. Filter size

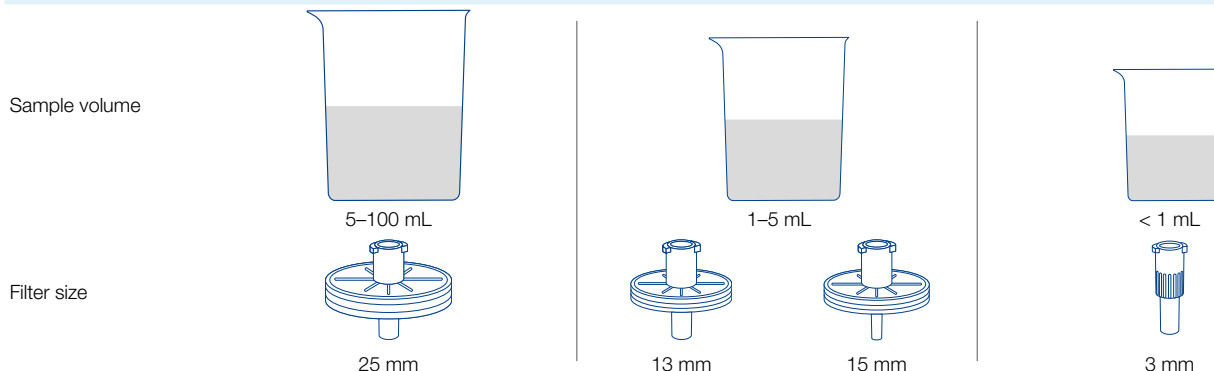

2. Pore size of filter membrane

Sample size

For general purpose
HPLC columns packed with particles
≥ 3 µm, GC, SFC, ...

Recommended for
UHPLC-, core-shell and HPLC columns,
packed with particles ≤ 3 µm, GC, SFC, ...



0.45 µm



0.20 µm

3. Membrane type

Properties of sample	Recommended	Alternatives		
Aqueous, polar hydrophilic low particle-load	PET	H-PTFE	MV	RC
high particle-load prefiltration required	GF/PET	GF/RC	GF/PVDF	
Mid-polar e.g. HPLC eluents	PET	PA	RC	
Proteins low binding capacity of proteins	CA	PVDF	PES	
high binding capacity of proteins	GF	GF/PET	GF/PVDF	
Strong acids and bases	H-PTFE	PTFE		
Organic, nonpolar, hydrophobic low particle-load	PTFE	PET		
high particle-load prefiltration required	GF/PET	GF/PVDF		
Aqueous, for ion chromatography determinations	IC			



MACHEREY-NAGEL

FilterFinder · easy switching to first-class filters

It is that simple

1. Choose previously used manufacturer
2. Choose previously used part number
3. Start searching
4. Suitable CHROMAFIL® syringe filter will be suggested

Use our FilterFinder online at www.mn-net.com/filterfinder





Polyester with glass fiber prefilter (GF/PET)



★ Key features

- Hydrophilic multipurpose membrane
- For polar as well as nonpolar samples
- The HPLC filter with glass fiber prefilter, especially suited for mixtures of water and organic solvents
- Recommended for solutions with a high load of particulate matter or for highly viscous samples. Glass fiber exhibits a high protein-binding capacity.

Ordering information

Type	Pore size [µm]	Membrane diameter [mm]	Color code		Standard pack		BIGbox	
			Top	Bottom	Filters/Pack	REF	Filters/Pack	REF
GF/PET-20/25	1.0/0.20	25	blue	orange	100	729032	400	729032.400
GF/PET-45/25	1.0/0.45	25	black	orange	100	729033	400	729033.400

Regenerated cellulose with glass fiber prefilter (GF/RC)



★ Key features

- Hydrophilic membrane
- For aqueous and organic-aqueous liquids, i.e. polar and medium polar sample solutions
- Recommended for solutions with a high load of particulate matter or for highly viscous aqueous solutions. Glass fiber exhibits a high protein-binding capacity.

Ordering information

Type	Pore size [µm]	Membrane diameter [mm]	Color code		Standard pack		BIGbox	
			Top	Bottom	Filters/Pack	REF	Filters/Pack	REF
GF/RC-20/25	1.0/0.20	25	blue	blue	100	729050	400	729050.400
GF/RC-45/25	1.0/0.45	25	black	blue	100	729051	400	729051.400

Polyvinylidene difluoride with glass fiber prefilter (GF/PVDF)



★ Key features

- Hydrophilic membrane
- Recommended for the filtration of biological samples with high particle loads. Glass fiber exhibits a high protein-binding capacity.
- Also suited for the filtration of aqueous samples

Ordering information

Type	Pore size [µm]	Membrane diameter [mm]	Color code		Standard pack		BIGbox	
			Top	Bottom	Filters/Pack	REF	Filters/Pack	REF
GF/P-45/25	1.0/0.45	25	black	white	100	729039	400	729039.400



Polyester (PET)



★ Key features

- Hydrophilic multipurpose membrane
- For polar as well as nonpolar solvents
- The HPLC filter, especially suited for mixtures of water and organic solvents
- For TOC/DOC determination
- Not cytotoxic, does not inhibit the growth of microorganisms and higher cells

Ordering information

Type	Pore size [µm]	Membrane diameter [mm]		Standard pack		BIGbox	
				Filters/Pack	REF	Filters/Pack	REF
CHROMAFIL[®] Xtra							
PET-20/13	0.20	13	labeled	100	729222		
PET-45/13	0.45	13	labeled	100	729223		
PET-20/25	0.20	25	labeled	100	729221	400	729221.400
PET-45/25	0.45	25	labeled	100	729220	400	729220.400
PET-120/25	1.2	25	labeled	100	729229	400	729229.400

Type	Pore size [µm]	Membrane diameter [mm]	Color code		Standard pack		BIGbox	
			Top	Bottom	Filters/Pack	REF	Filters/Pack	REF
CHROMAFIL[®]								
PET-20/15 MS	0.20	15	yellow	orange	100	729022		
PET-45/15 MS	0.45	15	colorless	orange	100	729023		
PET-20/25	0.20	25	yellow	orange	100	729021	400	729021.400
PET-45/25	0.45	25	colorless	orange	100	729020	400	729020.400

MS = minispikes on filter exit



Regenerated cellulose (RC)



★ Key features

- Hydrophilic membrane with very low adsorption
- For aqueous and organic-aqueous liquids, i.e. polar and medium polar sample solutions
- Binding capacity for proteins 84 µg per 25 mm filter

Ordering information

Type	Pore size [µm]	Membrane diameter [mm]	Standard pack		BIGbox			
			Filters/Pack	REF	Filters/Pack	REF		
CHROMAFIL[®] Xtra								
RC-20/13	0.20	13	labeled	100	729236			
RC-45/13	0.45	13	labeled	100	729237			
RC-20/25	0.20	25	labeled	100	729230	400	729230.400	
RC-45/25	0.45	25	labeled	100	729231	400	729231.400	
Type	Pore size [µm]	Membrane diameter [mm]	Color code		Standard pack		BIGbox	
			Top	Bottom	Filters/Pack	REF	Filters/Pack	REF
CHROMAFIL[®]								
RC-20/15 MS	0.20	15	yellow	blue	100	729036		
RC-45/15 MS	0.45	15	colorless	blue	100	729037		
RC-20/25	0.20	25	yellow	blue	100	729030	400	729030.400
RC-45/25	0.45	25	colorless	blue	100	729031	400	729031.400

MS = minispikes on filter exit

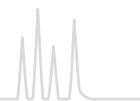

Polytetrafluoroethylene (PTFE)



★ Key features

- Hydrophobic membrane
- For nonpolar liquids and gases
- Very resistant towards all kinds of solvents as well as acids and bases
- Flushing with alcohol, followed by water, makes the original hydrophobic membrane more hydrophilic

Ordering information

Type	Pore size [µm]	Membrane diameter [mm]	Standard pack		BIGbox	
			Filters/Pack	REF	Filters/Pack	REF
CHROMAFIL[®] Xtra						
PTFE-20/13	0.20	13	labeled	100	729208	
PTFE-45/13	0.45	13	labeled	100	729209	
PTFE-20/25	0.20	25	labeled	100	729207	400 729207.400
PTFE-45/25	0.45	25	labeled	100	729205	400 729205.400
PTFE-100/25	1.0	25	labeled	100	729247	

Type	Pore size [µm]	Membrane diameter [mm]	Color code		Standard pack		BIGbox	
			Top	Bottom	Filters/Pack	REF	Filters/Pack	REF
CHROMAFIL[®]								
O-20/3	0.20	3	colorless	colorless	100	729014		
O-45/3	0.45	3	colorless	colorless	100	729015		
O-20/15 MS	0.20	15	yellow	colorless	100	729008		
O-45/15 MS	0.45	15	colorless	colorless	100	729009		
O-20/25	0.20	25	yellow	colorless	100	729007	400	729007.400

MS = minispikes on filter exit

Hydrophilized polytetrafluoroethylene (H-PTFE)



★ Key features

- Hydrophobic membrane with additional hydrophilic characteristic
- For polar and nonpolar solutions
- Resistant towards all kinds of solvents as well as acids and bases

Ordering information

Type	Pore size [µm]	Membrane diameter [mm]	Standard pack		BIGbox	
			Filters/Pack	REF	Filters/Pack	REF
CHROMAFIL[®] Xtra						
H-PTFE-20/13	0.20	13	labeled	100	729256	
H-PTFE-45/13	0.45	13	labeled	100	729257	
H-PTFE-20/25	0.20	25	labeled	100	729245	
H-PTFE-45/25	0.45	25	labeled	100	729246	400 729246.400



Cellulose mixed esters (MV)



★ Key features

- Hydrophilic membrane with very low adsorption
- For aqueous or polar solutions

Ordering information

Type	Pore size [µm]	Membrane diameter [mm]	Standard pack		BIGbox			
			Filters/Pack	REF	Filters/Pack	REF		
CHROMAFIL[®] Xtra								
MV-20/25	0.20	25	labeled	100	729206			
MV-45/25	0.45	25	labeled	100	729204	400	729204.400	
Type	Pore size [µm]	Membrane diameter [mm]	Color code		Standard pack		BIGbox	
			Top	Bottom	Filters/Pack	REF	Filters/Pack	REF
CHROMAFIL[®]								
A-20/25	0.20	25	yellow	yellow	100	729006	400	729006.400
A-45/25	0.45	25	colorless	yellow	100	729004	400	729004.400

Cellulose acetate (CA)



★ Key features

- Hydrophilic membrane
- For the filtration of water-soluble oligomers and polymers, especially suited for biological macromolecules
- Very high shape stability in aqueous solutions
- Extremely low binding capacity for proteins (21 µg / 25 mm filter)
- Also available in a sterile package (S) for filtration under sterile conditions (each filter individually sealed)

Ordering information

Type	Pore size [µm]	Membrane diameter [mm]	Standard pack		BIGbox			
			Filters/Pack	REF	Filters/Pack	REF		
CHROMAFIL[®] Xtra								
CA-20/13	0.20	13	labeled	100	729254			
CA-45/13	0.45	13	labeled	100	729255			
CA-20/25	0.20	25	labeled	100	729226	400	729226.400	
CA-45/25	0.45	25	labeled	100	729227	400	729227.400	
Type	Pore size [µm]	Membrane diameter [mm]	Color code		Standard pack		BIGbox	
			Top	Bottom	Filters/Pack	REF	Filters/Pack	REF
CHROMAFIL[®]								
CA-20/15 MS	0.20	15	yellow	red	100	729054		
CA-45/15 MS	0.45	15	colorless	red	100	729055		
CA-20/25	0.20	25	yellow	red	100	729026	400	729026.400
CA-45/25	0.45	25	colorless	red	100	729027	400	729027.400
Sterile filters								
CA-20/25 (S)	0.20	25	yellow	red	50	729024		
CA-45/25 (S)	0.45	25	colorless	red	50	729025		

MS = minispikes on filter exit; S = sterile filters

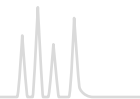

Polyamide (PA) = Nylon



★ Key features

- Rather hydrophilic membrane
- For aqueous and organic-aqueous medium polar liquids

Ordering information

Type	Pore size [µm]	Membrane diameter [mm]	Standard pack		BIGbox			
			Filters/Pack	REF	Filters/Pack	REF		
CHROMAFIL[®] Xtra								
PA-20/13	0.20	13	labeled	100	729248			
PA-45/13	0.45	13	labeled	100	729249			
PA-20/25	0.20	25	labeled	100	729212	400	729212.400	
PA-45/25	0.45	25	labeled	100	729213	400	729213.400	
Type	Pore size [µm]	Membrane diameter [mm]	Color code		Standard pack		BIGbox	
			Top	Bottom	Filters/Pack	REF	Filters/Pack	REF
CHROMAFIL[®]								
AO-20/3	0.20	3	colorless	colorless	100	729010		
AO-45/3	0.45	3	colorless	colorless	100	729011		
AO-20/15 MS	0.20	15	yellow	green	100	729048		
AO-45/15 MS	0.45	15	colorless	green	100	729049		
AO-20/25	0.20	25	yellow	green	100	729012	400	729012.400
AO-45/25	0.45	25	colorless	green	100	729013	400	729013.400

MS = minispikes on filter exit

Polyethersulfone (PES)



★ Key features

- Hydrophilic membrane
- For aqueous liquids and aqueous liquids with low organic contents
- Very low adsorption of pharmaceuticals and proteins
- Good stability against acids and bases
- Binding capacity for proteins 29 µg per 25 mm filter

Ordering information

Type	Pore size [µm]	Membrane diameter [mm]	Standard pack		BIGbox		
			Filters/Pack	REF	Filters/Pack	REF	
CHROMAFIL[®] Xtra							
PES-20/25	0.20	25	labeled	100	729240		
PES-45/25	0.45	25	labeled	100	729241	400	729241.400
PES-500/25	5.0	25	labeled	100	729242		



Polyvinylidene difluoride (PVDF)



★ Key features

- Hydrophilic membrane
- For 100 % aqueous samples, water-soluble oligomers and polymers like proteins
- Binding capacity for proteins 20 µg per 25 mm filter

Ordering information

Type	Pore size [µm]	Membrane diameter [mm]		Standard pack		BIGbox	
				Filters/Pack	REF	Filters/Pack	REF
CHROMAFIL® Xtra							
PVDF-20/13	0.20	13	labeled	100	729243		
PVDF-45/13	0.45	13	labeled	100	729244		
PVDF-20/25	0.20	25	labeled	100	729218	400	729218.400
PVDF-45/25	0.45	25	labeled	100	729219	400	729219.400

Type	Pore size [µm]	Membrane diameter [mm]	Color code		Standard pack			
			Top	Bottom	Filters/Pack	REF		
CHROMAFIL®								
PVDF-20/15 MS	0.20	15	yellow	white	100	729043		
PVDF-45/15 MS	0.45	15	colorless	white	100	729044		

MS = minispikes on filter exit

Glass fiber (GF)



★ Key features

- Inert filter, nominal pore size 1 µm, allows higher flow rates than small pore filters
- For solutions with high loads of particulate matter or for highly viscous solutions (e.g., soil samples, fermentation broths). Glass fiber exhibits a high protein-binding capacity.
- As prefilters for other CHROMAFIL® filters, they prevent plugging of the membrane

Ordering information

Type	Pore size [µm]	Membrane diameter [mm]		Standard pack		BIGbox	
				Filters/Pack	REF	Filters/Pack	REF
CHROMAFIL® Xtra							
GF-100/13	nominal 1.0	13	labeled	100	729234		
GF-100/25	nominal 1.0	25	labeled	100	729228	400	729228.400

Type	Pore size [µm]	Membrane diameter [mm]	Color code		Standard pack		BIGbox	
			Top	Bottom	Filters/Pack	REF	Filters/Pack	REF
CHROMAFIL®								
GF-100/15 MS	nominal 1.0	15	blue	colorless	100	729034		
GF-100/25	nominal 1.0	25	yellow	black	100	729028	400	729028.400

MS = minispikes on filter exit

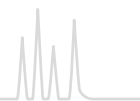

Special filter for ion chromatography (IC)



★ Key features

- For the filtration of aqueous liquids
- For optimal results with blind values < 5 ppb we recommend to prewash the filter with deionized water

Ordering information

Type	Pore size [µm]	Membrane diameter [mm]		Standard pack	
				Filters/Pack	REF
CHROMAFIL[®] Xtra					
IC-45/25	0.45	25	labeled	100	729258

Hints for using CHROMAFIL[®] syringe filters

For optimum filtration results we recommend to keep the following in mind:

- Either discard the first mL or rinse the filter unit with 1 mL of the solvent prior to filtration
- Before filling the syringe, draw about 1 mL air into the syringe in order to minimize the liquid remaining in the filter
- Start filtration with a slight pressure; this will optimize the throughput of the filter. As soon as particles accumulate on the filter, filtration will become more difficult and the pressure on the filter will increase.
- Change the filter whenever the resistance becomes too large in order to prevent rupture of the housing
- Do not apply CHROMAFIL[®] syringe filters on humans; they are only intended for lab use!
- Always use syringes ≥ 10 mL; smaller syringes can easily cause pressures above the 6 bar limit of the filters
- The temperature should not exceed 55 °C
- Do not re-use the filters

Disposable syringes with Luer tip



★ Key features

- Body and piston made from polypropylene (non sterile)

Ordering information

Volume	Pack of	REF
2 mL	100	729100
5 mL	100	729101
10 mL	100	729102



Chemical compatibility of filter materials

The chemical compatibility depends on several parameters such as time, pressure, temperature and concentration. In most cases, CHROMAFIL® filters will have only short contact with a solvent. In these cases they may be used despite of limited compatibility.

For example, a PTFE filter with PP housing does not liberate any UV-detectable substances during filtration of 5 mL THF, although PP shows only limited resistance towards THF.

The following table lists the chemical compatibility of our CHROMAFIL® materials.

Solvent	Material											
	MV	CA	RC	PA	PTFE	H-PTFE	PVDF	PES	PET	GF	IC	PP
Acetaldehyde	-	-	+	○	+	+	+	+	+	+		○
Acetic acid, 100 %	-	-	-	-	+	+	+	+	+	+		+
Acetone	-	-	+	+	+	+	-	-	+	+		+
Acetonitrile	-	-	+	+	+	+	+	+	+	+		+
Ammonia, 25 %	-	-	○	-	+	+	+	+	○	+	-	+
Benzene	+	+	+	+	+	+	○	+	+	+		○
n-Butanol	+	+	+	○	+	+	+	+	+	+		+
Cyclohexane	+	+	+	○	+	+	+	+	+	+		+
Dichloromethane	+	-	+	-	+	+	+	-	+	+		-
Diethyl ether	○	○	+	+	+	+	+	+	+	+		○
Dimethylformamide	-	-	○	+	+	+	-	-	+	+		+
1,4-Dioxane	-	-	+	+	+	+	○	-	+	+		○
Ethanol	-	+	+	+	+	+	+	+	+	+		+
Ethyl acetate	-	-	+	+	+	+	+	+	+	+		○
Ethylene glycol	○	○	+	+	+	+	+	+	+	+		+
Formic acid, 100 %	+	-	○	-	+	+	+	+	○	+		+
Hydrochloric acid, 30 %	-	-	-	-	+	+	+	+	-	+	-	+
Methanol	-	-	+	+	+	+	+	+	+	+		+
Nitric acid, 65 %	-	-	-	-	○	+	○		○	+	-	-
Oxalic acid, 10 % aqueous	+	-	+	-	+	+	+		+	+		+
Petroleum ether	+	+	+	+	+	+	+	+	+	+		+
Phosphoric acid, 80 %	-	-	○	-	+	+	○		+	+	-	+
Potassium hydroxide, 1 mol/L	-	-	○	+	+	+	○	○	○	+	+	+
2-Propanol	+	+	+	+	+	+	+	+	+	+		+
Sodium hydroxide, 1 mol/L	-	-	○	+	+	+	○	○	○	○	+	+
Tetrachloromethane	+	-	+	+	+	+	○		+	+		○
Tetrahydrofuran	-	-	+	○	+	+	+	-	+	+		○
Toluene	+	-	+	+	+	+	+	+	+	+		○
Trichloroethene	+	+	+	○	+	+	+	○	+	+		○
Trichloromethane (chloroform)	+	-	+	-	+	+	+	-	+	+		-
Urea	+	+	+	+	+	+	+		+	+		+
Water	+	+	+	+	+	+	+	+	+	+	+	+
Xylene	+	+	+	+	+		○	○	+	+		○

Data not guaranteed.

+ resistant, - not resistant, ○ limited resistance

Material

Membranes

MV = cellulose mixed esters, CA = cellulose acetate, RC = regenerated cellulose, PA = polyamide, PTFE = polytetrafluoroethylene, H-PTFE = hydrophilized polytetrafluoroethylene, PVDF = polyvinylidene difluoride, PES = polyethersulfone, PET = polyester, GF = glass fiber, IC = special filter for ion chromatography

Housing material

PP = polypropylene



CHROMAFIL® filtration cartridges



★ Key features

- Filtration cartridges for sample clarification under vacuum (e.g., using the CHROMABOND® vacuum manifold or SPE automation systems like Gilson ASPEC™, Rapidtrace®) or by gravity
- Cartridge sizes 3 mL and 6 mL
- Different membranes (PET, RC, PTFE, PVDF, GF) and pore sizes (0.2, 0.45 and 1.0 µm). Membrane materials correspond to the respective CHROMAFIL® syringe filters.

Ordering information

Description	Pore size [µm]	Pack of [cartridges]	Column volume	
			3 mL	6 mL
CHROMAFIL® filtration cartridges				
Filtration cartridges PET (polyester)	0.20	100	730578.320	730578.620
Filtration cartridges PET (polyester)	0.45	100	730578.345	730578.645
Filtration cartridges RC (regenerated cellulose)	0.20	100	730068.320	730068.620
Filtration cartridges RC (regenerated cellulose)	0.45	100	730068.345	730068.645
Filtration cartridges PTFE (polytetrafluoroethylene)	0.20	100	730570.320	730570.620
Filtration cartridges PTFE (polytetrafluoroethylene)	0.45	100	730570.345	730570.645
Filtration cartridges PVDF (polyvinylidene difluoride)	0.20	100	730579.320	730579.620
Filtration cartridges PVDF (polyvinylidene difluoride)	0.45	100	730579.345	730579.645
Filtration cartridges GF (glass fiber)	nom. 1.0	100	730517.3100	730517.6100

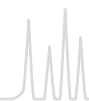

CHROMAFIL® MULTI 96 filter plates

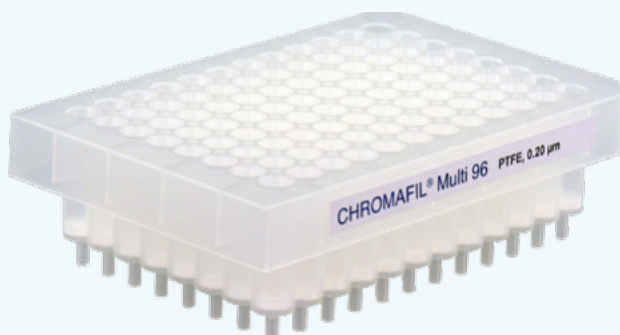

★ Key features

- 96-well polypropylene plates for the simultaneous filtration of 96 samples
- Advantages of this high-throughput system are:
 - Economical by saving time and solvent
 - The use of multi-channel pipettors facilitates liquid transfer steps
 - Readily adaptable to all common automated and robotic handling systems
 - Minimized dead volume ($\leq 40 \mu\text{L}$)
- Membrane materials correspond to the respective CHROMAFIL® syringe filters

Ordering information

Description	Pack of	REF
CHROMAFIL® MULTI 96 Filter plates		
Filter plates with cellulose mixed ester filter elements (0.20 μm)	1	738770.M
Filter plates with cellulose mixed ester filter elements (0.45 μm)	1	738771.M
Filter plates with RC filter elements (regenerated cellulose 0.2 μm)	1	738656.M
Filter plates with RC filter elements (regenerated cellulose 0.45 μm)	1	738657.M
Filter plates with PTFE filter elements (0.2 μm)	1	738660.M
Filter plates with PTFE filter elements (0.45 μm)	1	738661.M
Filter plates with PTFE filter elements (1.0 μm)	1	738662.M
Filter plates with PTFE filter elements (3.0 μm)	1	738663.M
Filter plates with PE filter elements (20 μm)	1	738655.M
Filter plates with PE filter elements (50 μm)	1	738659.M
Filter plates with glass fiber filter elements (nominal 1 μm)	1	738655.2M
Filter plates with glass fiber filter elements (nominal 3 μm)	1	738658.M
CHROMABOND® MULTI 96 vacuum manifold for monoblocks, with reservoir tank, vacuum gauge and control valve, for filtration with 96-well filter plates	1	738630.M

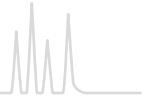



Contents

Basics.....	98
Crimp neck vials and caps N 8.....	101
Screw neck vials and caps N 8.....	102
Screw neck vials and caps N 9.....	104
Screw neck vials and caps N 10.....	108
Crimp neck vials and caps N 11.....	109
Snap ring vials and caps N 11.....	114
Crimp neck vials and caps N 13.....	118
Screw neck vials and caps N 13.....	119
Special vials and caps.....	120
Screw neck vials for storage of liquid samples.....	120
Snap cap vials for storage of powdery samples.....	123
Shell vials N 8 and N 12.....	124
Screw neck vials / magnetic screw caps N 18.....	125
Crimp neck vials and caps N 20.....	126
Screw neck vials and caps N 24.....	131
Containers / Vial racks.....	133
Crimping tools.....	134
Autosampler compatibility.....	136

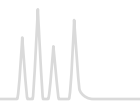

Technical data of vials

Except for the snap cap vials for storage of powdery samples and the blow-molded glass 70209.1, the vials of our program are made from 1st hydrolytic class glass. The dimensions stated in this catalog with respect to vial diameter and height are exact values. Please note that other suppliers often list rounded values (e.g., 12 x 32 mm instead of 11.6 x 32 mm), the actual dimensions are, however, identical due to the required fit in the instrument. Our data concerning the volume are defined realistically usable volumes, not calculated values. For reasons of safety we state rather low values. Here, too, deviations of data of other suppliers may occur, which either use the calculated volume (e.g., 2 mL instead of 1.5 mL) or a defined, realistically usable volume in the upper range (e.g., 1.8 mL instead of 1.5 mL). For suitability of certain vial types on instruments of the most important manufacturers please refer to the autosampler compatibility list at the end of this chapter.

Closure selection in GC/HPLC

The choice of the best closure depends on certain features of the instrument (needle type/design, transportation mechanism of the autosampler, etc.) as well as on the requirements of the application (temperature, sensitivity of the analysis, single/multiple injections, etc.) and thus is more complicated and more individual than selection of the correct vial type.

Basically the following recommendations can be made:

- Due to the relatively thick and blunt HPLC needles, only Silicone/PTFE closures, either with or without slit, should be used in combination with them
- Screw closures N 9 are universally suitable on most autosamplers, convenient in handling and available in a broad selection of different cap colors and septum materials. They fulfill all requirements with regard to tightness and analytical purity for GC as well as for HPLC. Due to the relatively thin septa penetration is safe and easy. Crimp closures N 11 are also universally suitable with regard to autosampler compatibility, however, they are not as safe and convenient in their closing technique as the screw closures N 9.
- Snap ring closures N 11 should only be used in HPLC, as the punctual compacting pressure of the septum against the vial rim by the four pins in the cap does not achieve the same level of tightness as the evenly applied pressure through a circular thread or by crimping.

- For sensitive analyses only high purity Silicone/PTFE closures can be used; if additionally there is a need for minimal coring during penetration, a PTFE/Silicone/PTFE septum (sandwich septum) is recommendable.
- Cap colors may be used for marking (sample marking/lab marking/shift marking). However, please consider that some autosamplers work with photocells which may not be able to recognize transparent caps.
- For sample storage closed top screw closures (without center hole) should be used. Generally, these also need an elastomeric liner for sealing vials with liquid samples tightly.

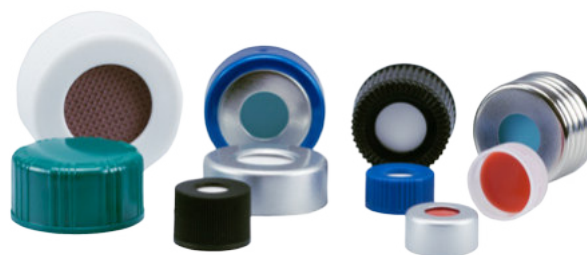

- Due to their artificially reduced cap height screw caps N 9 don't have a standardized thread design. Therefore, it is recommendable only to use vials and closures from one source of supply, in order to ensure a harmonious and tight matching of both components.
- Replacement septa are partially available, however, in case of manual assembly you have the risk of contamination with skin fat/sweat and of a possible wrong side orientation. Therefore we highly recommend only to use ready assembled closures, where the liner perfectly matches the cap and has been automatically inserted under strict hygienic conditions.
- Normally ready assembled closures should be suitable for all types of needles, provided the proper type of septum has been selected. Nevertheless, there might be cases where usage of bonded closures (cap and liner form an inseparable unit) can be recommendable. Example: blunt HPLC needle, however, due to the risk of sample loss/concentration changes no septa with slit can be used. In order to avoid that the unslit septum is pushed into the vial by the needle, you use a bonded closure with unslit septum.
- The following table shows the different physical and chemical properties of the various elastomeric septa materials:



Septa Guide

	Temperature resistance from/to	Analytical purity	Fragmentation due to hardness and molecular structure (coring)	Hardness (needle penetration)	Resealability (in case of multiple injections)
PTFE virginal	-200 °C / 260 °C	very high		very hard (but very thin material)	no resealability
Natural rubber / PTFE	-40 °C / 120 °C	low	high, big particles	very hard	high
Red Rubber / TEF (FEP)	-40 °C / 110 °C	medium	medium	medium hard	medium
Butyl	-40 °C / 120 °C	medium	medium	medium hard	medium
Butyl / PTFE	-40 °C / 120 °C	medium	medium	medium hard	medium
Silicone / PTFE	-60 °C / 200 °C	high	low to medium	soft	low to medium
PTFE / Silicone / PTFE	-60 °C / 200 °C	high	very low	soft	very low

Certificates

Upon request we can issue (batch related) certificates of conformity for all vials, inserts and closures, if this is required for your own ISO documentation.

Samples

Sample packs of all vials and closures can be requested at any time. The sample packs contain 5 pieces of the respective product. These can be requested cost-free with the REF number of the respective product plus the addition ".MUSTER" (e.g., 1 x 70201HP.MUSTER = 1 sample pack with five vials of 70201HP).



Example for a sample pack with five vials



Example for a sample pack with five screw closures

Packaging



Vials: normally packed with 100 pieces in a PP box, bottom part being shrink-wrapped



Closures: normally packed with 100 pieces in a resealable PE zip lock bag



Vial Kits with 100 vials and closures each (for all vials 11.6 x 32 mm)

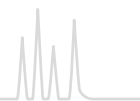

Literature

The following literature, which contains vials and caps, can be requested free of charge under the indicated KAT no.

Brochure vials and caps (English): KATEN200010

Link to the PDF download: www.mn-net.com/vials

Chromatography catalog (English): KATEN200001

Link to the PDF download: www.mn-net.com → Chromatography → Customer Services → Catalog download

Poster autosampler vials and caps (English): KATEN200086

Brochure crimping tools (English): KATEN200100

Link to the PDF download: www.mn-net.com/vials → Vial accessories

Poster "Optimal crimping" (German/English): KATDE/EN200153

Link to the PDF download: www.mn-net.com/vials → Vial accessories

Website guide

Up-dated product range vials and caps:

www.mn-net.com/vials

VialFinder as translation tool for cross-references:

www.mn-net.com/vialfinder

General literature on chromatography products (PDF download):

www.mn-net.com/chroma → Customer services → Catalog download

Instructions for manual crimping tools (PDF download):

www.mn-net.com/manualcrimper (left pane)

Instructions for electronic crimping tools (PDF download):

www.mn-net.com/electroniccrimper (left pane)

Current edition of the "Chroma-News" as well as their archive:

www.mn-net.com/chroma (right pane)

Decision tool for selecting the most optimal crimping tool for your own user profile (PDF download):

www.mn-net.com/vials → Vial accessories (containers, crimping tools) → blue marked link to PDF Download in the yellow box on top of the section

Translation tool for cross-references: the VialFinder at www.mn-net.com/vialfinder

The VialFinder is a database-driven translation tool for cross-references of instrument manufacturers and suppliers of consumables worldwide. The VialFinder immediately shows all options available from MACHEREY-NAGEL for the product of interest. The Finder shows 1:1 matches (in bold type) as well as possible alternative products (in normal type) that – in spite of technical differences to the indicated product – are suitable for the application. The corresponding link on the product description will lead you to the appropriate product page on our website that will give information on technical product features as well as possible illustrations of the product. In case you cannot find your part number via the VialFinder, please send your inquiry by e-mail to vials@mn-net.com providing us with all product information you may have. We will then check, if we can offer an equivalent product.



Miscellaneous

Should you need more information concerning this product range, you can ask for our separate brochure "Vials and caps" (KATEN200010), which – among others – features 1:1 drawings of all glass products.

Except where explicitly mentioned, septa are assembled ready to use. Septa beneath or beside a cap are shown for illustration purposes only, and they are pictured upside down.

All drawings in this chapter are scale 1:2.

General remarks

All information is subject to technical changes. All product data are subject to the currently valid specifications.

Contacts

Aside from your known contacts of our sales team you can also contact product management for technical questions at: vials@mn-net.com



Crimp neck vials and caps N 8



★ Key features

- 0.2–0.8 mL usable volume
- Adapter required for use in an autosampler
- Available with flat, round or conical bottom
- Economic closure versions: three-layer septum Natural rubber / Butyl / TEF or two-layer septum Red Rubber / FEP
- For more demanding analyses: high purity Silicone / PTFE septa

Ordering information

Crimp neck vials N 8

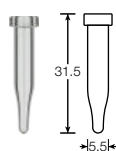

70286

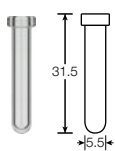

70282

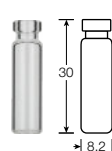

70251

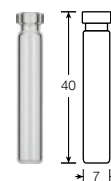

702002

Type of vial	Usable volume	(Illustrations scale 1:2) OD x height	Pack of	REF
Clear, conical	0.2 mL	5.5 x 31.5 mm	100	70286
Clear, round bottom	0.3 mL	5.5 x 31.5 mm	100	70282
Clear, flat bottom	0.8 mL	8.2 x 30 mm	100	70251
Clear, flat bottom	0.7 mL	7 x 40 mm	100	702002

Ready assembled crimp closures N 8 and plain crimp caps N 8



Cap description	Septa description	Thickness	Pack of	REF
N 8 aluminium crimp cap, silver, center hole	PTFE virginal, white	0.25 mm	100	70283
N 8 aluminium crimp cap, silver, center hole	Natural rubber / Butyl red-orange / TEF colorless	1.0 mm	100	70252.1
N 8 aluminium crimp cap, silver, center hole	Red Rubber / FEP colorless	1.0 mm	100	702025
N 8 aluminium crimp cap, silver, center hole	Silicone white / PTFE red	1.0 mm	100	70289
N 8 aluminium crimp cap, silver, center hole	PTFE red / Silicone white / PTFE red	1.0 mm	100	702878
N 8 aluminium crimp cap, silver, center hole	no liner	–	100	702800

Crimping tools N 8

Description	Pack of	REF
Manual crimper (standard) for 8 mm aluminium crimp caps	1	735126
Manual decapper (standard) for 8 mm aluminium crimp caps	1	735408
Manual ergonomic crimper for 8 mm aluminium crimp caps	1	735208



Manual crimper (standard)



Manual ergonomic crimper



Screw neck vials and caps N 8

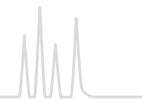

Screw neck vials and caps N 8

★ Key features

- Are among the oldest vial types for HPLC and GC (besides crimp neck vials N 11)
- More and more replaced by screw neck vials N 9, which are easier to fill due to the wide opening compared to screw neck vials N 8 with small opening
- Due to the cap design not universally usable on all autosamplers in GC and HPLC – however, often used on instruments of VWR (Merck®) / Hitachi, Varian®, Knauer, Gilson®, Shimadzu® and others
- In combination with closed top screw closures also used for sample storage (see page 120)
- Now also available as practical Vial Kits with 100 vials and closures each



Ordering information

Screw neck vials N 8, small opening (8-425 thread), and compatible inserts

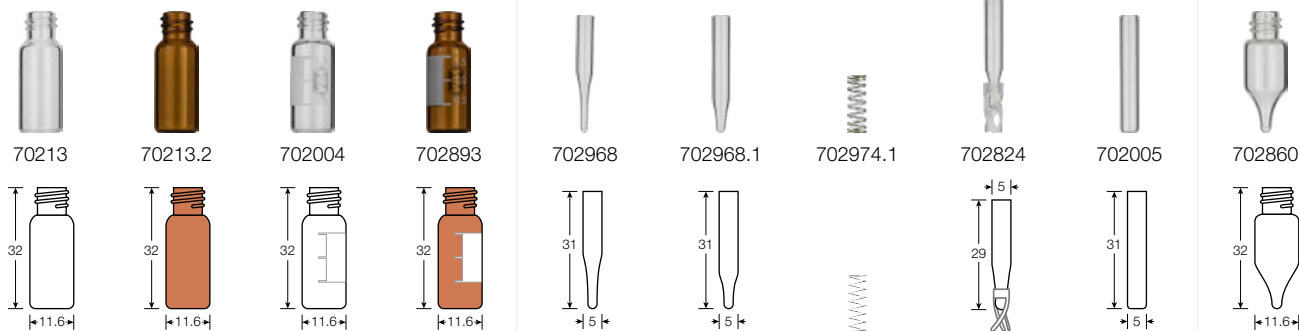

Type of vial	Usable volume	(Illustrations scale 1:2) OD x height	Pack of	REF
Clear, flat bottom	1.5 mL	11.6 x 32 mm	100	70213
Amber, flat bottom	1.5 mL	11.6 x 32 mm	100	70213.2
Clear, flat bottom, label and scale	1.5 mL	11.6 x 32 mm	100	702004
Amber, flat bottom, label and scale	1.5 mL	11.6 x 32 mm	100	702893
Insert for small opening vials, clear, conical, 15 mm tip	0.1 mL	5 x 31 mm	100	702968*
Insert for small opening vials, clear, conical, 9 mm tip	0.15 mL	5 x 31 mm	100	702968.1*
Metal spring for conical inserts 5 x 31 mm	–	–	100	702974.1
Insert for small opening vials, clear, with plastic spring	0.1 mL	5 x 29 mm	100	702824
Insert for small opening vials, clear, flat bottom	0.25 mL	5 x 31 mm	100	702005
Micro-vial, clear, conical	1.1 mL	11.6 x 32 mm	100	702860

* Optionally you may use metal springs 702974.1 in combination with these products to push them up in the vial.

Screw neck vials and caps N 8



Ordering information

Ready assembled screw closures N 8 and plain screw caps N 8

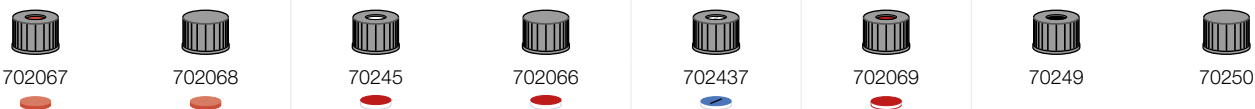

Cap description	Septa description	Thickness	Pack of	REF
N 8 PP screw cap, black, center hole	Red Rubber / FEP colorless	1.3 mm	100	702067
as above, but with closed top	Red Rubber / FEP colorless	1.3 mm	100	702068
N 8 PP screw cap, black, center hole	Silicone white / PTFE red	1.3 mm	100	70245
as above, but with closed top	Silicone white / PTFE red	1.3 mm	100	702066
N 8 PP screw cap, black, center hole	Silicone white / PTFE blue, slit	1.0 mm	100	702437
N 8 PP screw cap, black, center hole	PTFE red / Silicone white / PTFE red	1.0 mm	100	702069
N 8 PP screw cap, black, center hole	no liner	-	100	70249
as above, but with closed top	no liner	-	100	70250

N 8 Septa for screw caps N 8

Material	Illustration	Thickness	Pack of	REF
Septum N 8, PTFE virginal, white		0.25 mm	100	70261
Septum N 8, Red Rubber / FEP colorless		1.3 mm	100	702070
Septum N 8, Silicone white / PTFE red		1.3 mm	100	70248
Septum N 8, Silicone white / PTFE blue, slit		1.0 mm	100	702481

Vial Kits screw neck N 8

Packs of 100 vials and 100 closures, each

Closure →



70245



702437



702067

Vial ↓

70213: 1.5 mL, clear, flat bottom	702238	702247	702246
70213.2: 1.5 mL, amber, flat bottom	702249	702251	702248

Other Vial Kits on request.





Screw neck vials and caps N 9

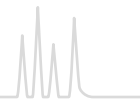

Screw neck vials and caps N 9



★ Key features

- Can be used on almost all HPLC and GC autosamplers
- Large range of vials and closures
- Also available as bonded closures (advantage: thick (blunt) HPLC needles cannot push the septum into the vial)
- Also available as convenient Vial Kits with 100 vials and 100 caps and as presealed vial-closure combinations
- Now also 1.5 mL polypropylene vials N 9 for special applications (e.g., IC, CE, etc.)

Ordering information

Screw neck vials N 9, wide opening (short thread), and compatible inserts

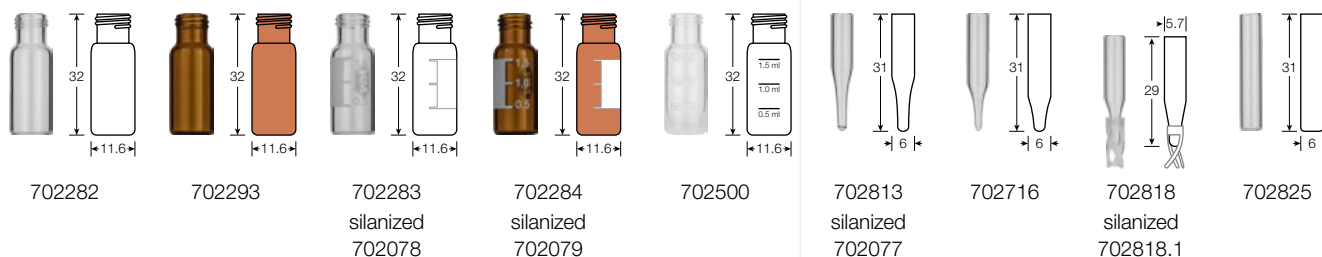

Type of vial	Usable volume	(Illustrations scale 1:2)		
		OD x height	Pack of	REF
Clear, flat bottom	1.5 mL	11.6 x 32 mm	100	702282
Amber, flat bottom	1.5 mL	11.6 x 32 mm	100	702293
Clear, flat bottom, label and scale	1.5 mL	11.6 x 32 mm	100	702283
as above, silanized	1.5 mL	11.6 x 32 mm	100	702078
Amber, flat bottom, label and scale	1.5 mL	11.6 x 32 mm	100	702284
as above, silanized	1.5 mL	11.6 x 32 mm	100	702079
Polypropylene, transparent, with filling lines	1.5 mL	11.6 x 32 mm	100	702500
Insert for wide opening vials, clear, conical, 15 mm tip	0.2 mL	6 x 31 mm	100	702813
as above, silanized	0.2 mL	6 x 31 mm	100	702077
Insert for wide opening vials, clear, conical, 12 mm tip	0.25 mL	6 x 31 mm	100	702716
Insert for wide opening vials, clear, with plastic spring	0.1 mL	5.7 x 29 mm	100	702818
as above, silanized	0.1 mL	5.7 x 29 mm	100	702818.1
Insert for wide opening vials, clear, flat bottom	0.3 mL	6 x 31 mm	100	702825

Screw neck vials and caps N 9



Ordering information

Screw neck micro-vials N 9, wide opening (short thread)

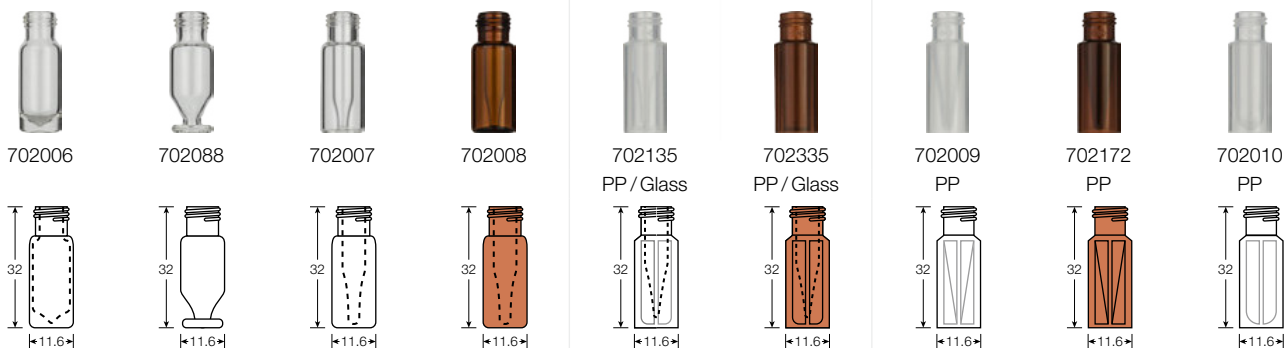

Type of vial	Usable volume	OD x height	Pack of	REF
Micro-vial, clear, 15 µL funnel in solid glass bottom	1.1 mL	11.6 x 32 mm	100	702006
Micro-vial, clear, conical, with round pedestal glass plate	1.1 mL	11.6 x 32 mm	100	702088
Micro-vial, clear, with integrated 0.2 mL insert	0.2 mL	11.6 x 32 mm	100	702007
Micro-vial, amber, with integrated 0.2 mL insert	0.2 mL	11.6 x 32 mm	100	702008
Micro-vial, polypropylene, transparent, with integrated 0.2 mL glass insert, conical	0.2 mL	11.6 x 32 mm	100	702135*
Micro-vial, polypropylene, amber, with integrated 0.2 mL glass insert, conical	0.2 mL	11.6 x 32 mm	100	702335*
Micro-vial, polypropylene, transparent, with inner cone	0.3 mL	11.6 x 32 mm	100	702009
Micro-vial, polypropylene, amber, with inner cone	0.3 mL	11.6 x 32 mm	100	702172
Micro-vial, polypropylene, transparent, with round bottom insert	0.7 mL	11.6 x 32 mm	100	702010

* upon request also available with an integrated silanized glass insert

Pre-assembled vial-insert combinations with screw neck N 9

Vial description	Insert description	Pack of	REF
Vial 702282: 1.5 mL, clear, flat bottom	with pre-assembled micro-insert 702813: 0.2 mL, conical, 15 mm tip	100	702177
Vial 702283: 1.5 mL, clear, flat bottom, label and scale	with pre-assembled micro-insert 702813: 0.2 mL, conical, 15 mm tip	100	702178
Vial 702284: 1.5 mL, amber, flat bottom, label and scale	with pre-assembled micro-insert 702813: 0.2 mL, conical, 15 mm tip	100	702179

Further pre-assembled vial-insert combinations on request

Bonded screw closures N 9 (septum firmly connected with the cap; cannot be removed)



Cap description	Septa description	Thickness	Pack of	REF
N 9 PP bonded screw cap, blue, center hole	Red Rubber / TEF colorless	1.0 mm	100	702028
N 9 PP bonded screw cap, blue, center hole	Silicone beige / PTFE white	1.3 mm	100	702026
N 9 PP bonded screw cap, blue, center hole	Silicone beige / PTFE white, slit	1.3 mm	100	702027





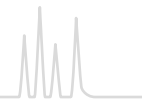































Screw neck vials and caps N 9



Ordering information

Ready assembled screw closures N 9

Cap description	Septa description	Thickness	Pack of	REF	
 702029	 702031	 702032			
N 9 PP screw cap, transparent, center hole	PTFE virginal, white	0.25 mm	100	702029	
N 9 PP screw cap, blue, center hole	PTFE virginal, white	0.25 mm	100	702031	
N 9 PP screw cap blue, closed top	PTFE virginal, white	0.25 mm	100	702032	
 702030	 702732	 702080	 702081	 702082	 702147
 702033					
N 9 PP screw cap, transparent, center hole	Red Rubber / FEP colorless	1.0 mm	100	702030	
N 9 PP screw cap, blue, center hole	Red Rubber / FEP colorless	1.0 mm	100	702732	
N 9 PP screw cap, black, center hole	Red Rubber / FEP colorless	1.0 mm	100	702080	
N 9 PP screw cap, red, center hole	Red Rubber / FEP colorless	1.0 mm	100	702081	
N 9 PP screw cap, green, center hole	Red Rubber / FEP colorless	1.0 mm	100	702082	
N 9 PP screw cap, yellow, center hole	Red Rubber / FEP colorless	1.0 mm	100	702147	
N 9 PP screw cap blue, closed top	Red Rubber / FEP colorless	1.0 mm	100	702033	
 702287	 702287.1	 702036	 702037	 702038	 702107
 702155	 702034				
N 9 PP screw cap, transparent, center hole	Silicone white / PTFE red	1.0 mm	100	702287	
N 9 PP screw cap, blue, center hole	Silicone white / PTFE red	1.0 mm	100	702287.1	
N 9 PP screw cap, black, center hole	Silicone white / PTFE red	1.0 mm	100	702036	
N 9 PP screw cap, red, center hole	Silicone white / PTFE red	1.0 mm	100	702037	
N 9 PP screw cap, green, center hole	Silicone white / PTFE red	1.0 mm	100	702038	
N 9 PP screw cap, yellow, center hole	Silicone white / PTFE red	1.0 mm	100	702107	
N 9 magnetic screw cap, silver, center hole	Silicone white / PTFE red	1.0 mm	100	702155	
N 9 PP screw cap blue, closed top	Silicone white / PTFE red	1.0 mm	100	702034	
 702288	 702288.1	 702039	 702040	 702083	 702109
N 9 PP screw cap, transparent, center hole	Silicone white / PTFE blue, slit	1.0 mm	100	702288	
N 9 PP screw cap, blue, center hole	Silicone white / PTFE blue, slit	1.0 mm	100	702288.1	
N 9 PP screw cap, black, center hole	Silicone white / PTFE blue, slit	1.0 mm	100	702039	
N 9 PP screw cap, red, center hole	Silicone white / PTFE blue, slit	1.0 mm	100	702040	
N 9 PP screw cap, green, center hole	Silicone white / PTFE blue, slit	1.0 mm	100	702083	
N 9 PP screw cap, yellow, center hole	Silicone white / PTFE blue, slit	1.0 mm	100	702109	
 702286	 702035	 702158	 702084	 702085	 702159
N 9 PP screw cap, transparent, center hole	PTFE red / Silicone white / PTFE red	1.0 mm	100	702286	
N 9 PP screw cap, blue, center hole	PTFE red / Silicone white / PTFE red	1.0 mm	100	702035	
N 9 PP screw cap, black, center hole	PTFE red / Silicone white / PTFE red	1.0 mm	100	702158	
N 9 PP screw cap, red, center hole	PTFE red / Silicone white / PTFE red	1.0 mm	100	702084	
N 9 PP screw cap, green, center hole	PTFE red / Silicone white / PTFE red	1.0 mm	100	702085	
N 9 PP screw cap, yellow, center hole	PTFE red / Silicone white / PTFE red	1.0 mm	100	702159	
 702160	 702161	 702162	 702163	 702164	 702165
N 9 PP screw cap, transparent, center hole	no liner	-	100	702160	
N 9 PP screw cap, blue, center hole	no liner	-	100	702161	
N 9 PP screw cap, black, center hole	no liner	-	100	702162	
N 9 PP screw cap, red, center hole	no liner	-	100	702163	
N 9 PP screw cap, green, center hole	no liner	-	100	702164	
N 9 PP screw cap, yellow, center hole	no liner	-	100	702165	

Screw neck vials and caps N 9



Ordering information

N 9 septa for screw caps N 9

Material	Illustration	Thickness	Pack of	REF
PTFE virginal, white		0,25 mm	100	702043
Red Rubber / FEP colorless		1.0 mm	100	702041
Silicone white / PTFE red		1.0 mm	100	702042
Silicone white / PTFE blue, slit		1.0 mm	100	702148

Vial Kits screw neck N 9

Packs of 100 vials and 100 closures, each

	Closure →				
Vial ↓	702287.1	702288.1	702732	702026	702027
702282: 1.5 mL, clear, flat bottom	702201	702204	702207		702244
702283: 1.5 mL, clear, flat bottom, label and scale	702202	702205	702208	702211	702213
702284: 1.5 mL, amber, flat bottom, label and scale	702203	702206	702209	702212	702214
702009: 0.3 mL, PP, transparent, with inner cone		702226			

Other Vial Kits on request.



Vial Kit with screw neck vials and closures N 9



Pre-sealed vial-closure combination

Ordering information

Pre-sealed vial-closure combinations with screw neck N 9

Vial description	Closure description	Pack of	REF
Pre-sealed vials 702282: 1.5 mL screw neck vial N 9, 11.6 x 32 mm, clear, flat bottom, wide opening	pre-screwed with 702732: N 9 PP screw cap, blue, center hole, Red Rubber/FEP colorless, 1.0 mm	100	702857
Pre-sealed vials 702283: 1.5 mL screw neck vial N 9, 11.6 x 32 mm, clear, flat bottom, wide opening, label and scale	pre-screwed with 702732: N 9 PP screw cap, blue, center hole, Red Rubber/FEP colorless, 1.0 mm	100	702858
Pre-sealed vials 702282: 1.5 mL screw neck vial N 9, 11.6 x 32 mm, clear, flat bottom, wide opening	pre-screwed with 702287.1: N 9 PP screw cap, blue, center hole, Silicone white/PTFE red, 1.0 mm	100	702874
Pre-sealed vials 702283: 1.5 mL screw neck vial N 9, 11.6 x 32 mm, clear, flat bottom, wide opening, label and scale	pre-screwed with 702288.1: N 9 PP screw cap, blue, center hole, Silicone white/PTFE blue, slit, 1.0 mm	100	702863
Pre-sealed vials 702284: 1.5 mL screw neck vial N 9, 11.6 x 32 mm, amber, flat bottom, wide opening, label and scale	pre-screwed with 702288.1: N 9 PP screw cap, blue, center hole, Silicone white/PTFE blue, slit, 1.0 mm	100	702873
Pre-sealed vials 702283: 1.5 mL screw neck vial N 9, 11.6 x 32 mm, clear, flat bottom, wide opening, label and scale	pre-screwed with 702026: N 9 PP bonded screw cap, blue, center hole, Silicone beige / PTFE white, 1.3 mm	100	702864

Other pre-sealed vial-closure combinations on request.



Screw neck vials and caps N 10

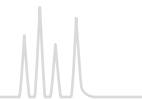

Screw neck vials and caps N 10



★ Key features

- Wide opening for easy filling
- Due to the cap height not universally suitable for all instruments
- Large range of bonded screw closures for a safe penetration (septa firmly connected with the cap; cannot be removed)
- Often used on Jasco, Shimadzu® and PerkinElmer® instruments
- On request also available as convenient Vial Kits with 100 vials and 100 caps

Ordering information

Screw neck vials N 10, wide opening (10-425 thread), and compatible inserts

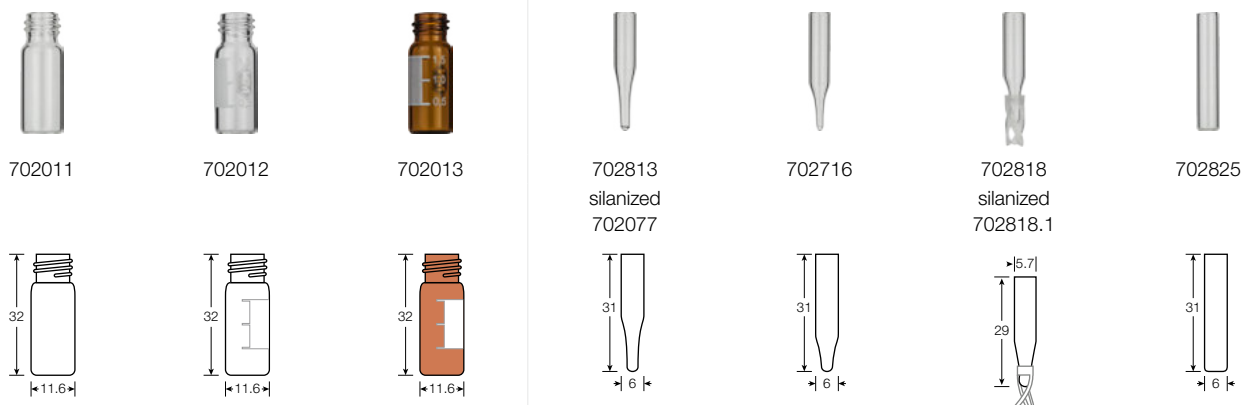

Type of vial	Usable volume	(Illustrations scale 1:2) OD x height	Pack of	REF
Clear, flat bottom	1.5 mL	11.6 x 32 mm	100	702011
Clear, flat bottom, label and scale	1.5 mL	11.6 x 32 mm	100	702012
Amber, flat bottom, label and scale	1.5 mL	11.6 x 32 mm	100	702013
Insert for wide opening vials, clear, conical, 15 mm tip	0.2 mL	6 x 31 mm	100	702813
as above, silanized	0.2 mL	6 x 31 mm	100	702077
Insert for wide opening vials, clear, conical, 12 mm tip	0.25 mL	6 x 31 mm	100	702716
Insert for wide opening vials, clear, with plastic spring	0.1 mL	5.7 x 29 mm	100	702818
as above, silanized	0.1 mL	5.7 x 29 mm	100	702818.1
Insert for wide opening vials, clear, flat bottom	0.3 mL	6 x 31 mm	100	702825

Screw closures N 10 and plain screw caps N 10



Cap description	Septa description	Thickness	Pack of	REF
N 10 PP bonded screw cap*, black, center hole	Red Rubber / TEF colorless	1.0 mm	100	702044
N 10 PP bonded screw cap*, black, center hole	Silicone white / PTFE beige	1.5 mm	100	702045
N 10 PP bonded screw cap*, black, center hole	Silicone white / PTFE red	1.0 mm	100	702046
N 10 PP bonded screw cap*, black, center hole	Silicone white / PTFE blue, slit	1.5 mm	100	702047
N 10 PP screw cap, black, center hole	PTFE red / Silicone white / PTFE red	1.0 mm	100	702048
N 10 PP screw cap, black, center hole	no liner	-	100	702049

* Septum firmly connected with the cap, cannot be removed.



Crimp neck vials and caps N 11



★ Key features

- Broad variety of standard crimp neck vials (with small or wide opening), as well as crimp neck micro-vials for smaller sample volumes
- Economic closures: Natural rubber / TEF (2 layers), Natural rubber / Butyl / TEF (3 layers) and Red Rubber / FEP (2 layers)
- For more demanding analyses: analytically pure Silicone / PTFE septa with lower fragmentation
- Magnetic closure: REF 702879 for use on CTC GC PAL
- Manual and electronic crimping tools for vials N 11 can be found on pages 113 and 134–135

Ordering information

Crimp neck vials N 11, small opening, and compatible inserts

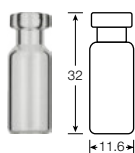

70201CG



70214CG

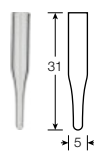

702968

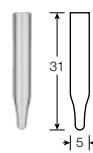

702968.1

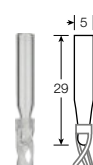

702824

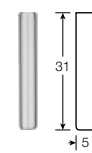

702005

Type of vial	Usable volume	(Illustrations scale 1:2) OD x height	Pack of	REF
Clear, flat bottom, small opening	1.5 mL	11.6 x 32 mm	100	70201CG
Amber, flat bottom, small opening	1.5 mL	11.6 x 32 mm	100	70214CG
Insert for small opening vials, clear, conical, 15 mm tip	0.1 mL	5 x 31 mm	100	702968*
Insert for small opening vials, clear, conical, 9 mm tip	0.15 mL	5 x 31 mm	100	702968.1*
Insert for small opening vials, clear, with plastic spring	0.1 mL	5 x 29 mm	100	702824
Insert for small opening vials, clear, flat bottom	0.25 mL	5 x 31 mm	100	702005

* Optionally you may use metal springs 702974.1 in combination with these products to push them up in the vial.



MACHEREY-NAGEL CHROMABOND® QuEChERS

The “Quick Easy Cheap Effective Rugged Safe” method

- High throughput, because of an easy handling and time-saving procedure
- Useful for sample preparation of many pesticides (“multi method”)
- Broad range of applications for different food
- Low solvent amounts
- High reproducibility and recovery rates
- No need for chlorinated solvents



More information from page 57 onwards as well as online at www.mn-net.com/quechers



Crimp neck vials and caps N 11

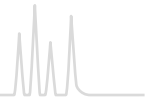

Crimp neck vials N 11, wide opening, and compatible inserts



70201HP

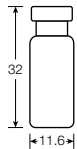

70201HP.2

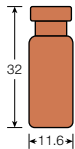

702885
silanized
702075

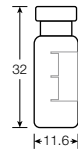

702892
silanized
702076

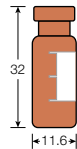

702813
silanized
702077



702716



702818
silanized
702818.1



702825



Type of vial	Usable volume	(Illustrations scale 1:2) OD x height	Pack of	REF
Clear, flat bottom, wide opening	1.5 mL	11.6 x 32 mm	100	70201HP
Amber, flat bottom, wide opening	1.5 mL	11.6 x 32 mm	100	70201HP.2
Clear, flat bottom, wide opening, label and scale	1.5 mL	11.6 x 32 mm	100	702885
as above, silanized	1.5 mL	11.6 x 32 mm	100	702075
Amber, flat bottom, wide opening, label and scale	1.5 mL	11.6 x 32 mm	100	702892
as above, silanized	1.5 mL	11.6 x 32 mm	100	702076
Insert for wide opening vials, clear, conical, 15 mm tip	0.2 mL	6 x 31 mm	100	702813
as above, silanized	0.2 mL	6 x 31 mm	100	702077
Insert for wide opening vials, clear, conical, 12 mm tip	0.25 mL	6 x 31 mm	100	702716
Insert for wide opening vials, clear, with plastic spring	0.1 mL	5.7 x 29 mm	100	702818
as above, silanized	0.1 mL	5.7 x 29 mm	100	702818.1
Insert for wide opening vials, clear, flat bottom	0.3 mL	6 x 31 mm	100	702825



Optimal crimping

For an optimal crimp result the crimping tool needs to be adjusted to:

- Type and height of the vial's crimp neck
- Thickness and hardness of the septa
- Properties of the cap (type, material)

For doing so, please refer to the instruction manual of the individual tool.

Permanent control of the crimp result and thus of the crimping tool settings is necessary.

Incorrect crimping can be recognized by the following features:



Cap deformation



Pulled up edge of the center hole



Strong formation of wrinkles



Convex looking liner



Cap can be turned with only low expenditure of power

Crimp neck vials and caps N 11



Ordering information

Crimp neck micro-vials N 11

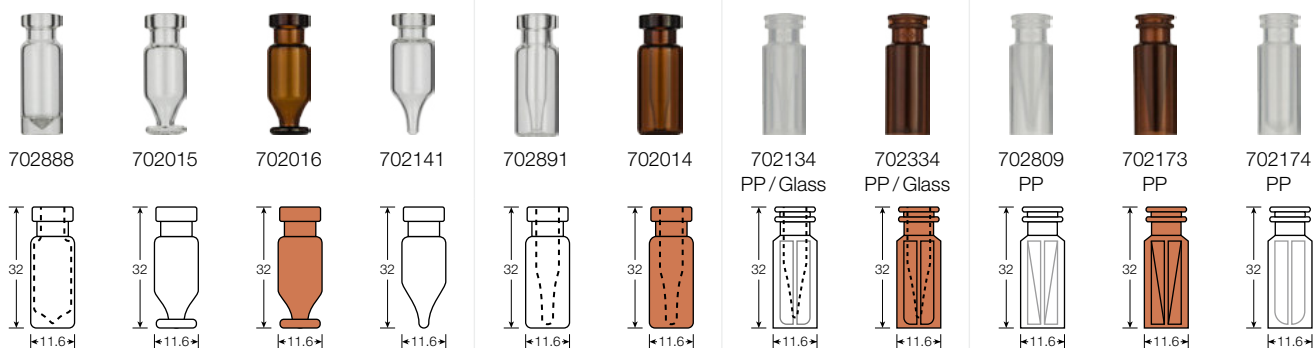

Type of vial	Usable volume	OD x height	Pack of	REF
Micro-vial, clear, flat bottom	1.1 mL	11.6 x 32 mm	100	702888
Micro-vial, clear, conical, with round pedestal glass plate	1.1 mL	11.6 x 32 mm	100	702015
Micro-vial, amber, conical, with round pedestal glass plate	1.1 mL	11.6 x 32 mm	100	702016
Micro-vial, clear, conical	1.1 mL	11.6 x 32 mm	100	702141
Micro-vial, clear, with integrated 0.2 mL insert	0.2 mL	11.6 x 32 mm	100	702891
Micro-vial, amber, with integrated 0.2 mL insert	0.2 mL	11.6 x 32 mm	100	702014
Micro-vial, polypropylene, transparent, with integrated 0.2 mL glass insert, conical	0.2 mL	11.6 x 32 mm	100	702134*
Micro-vial, polypropylene, amber, with integrated 0.2 mL glass insert, conical	0.2 mL	11.6 x 32 mm	100	702334*
Micro-vial, polypropylene, transparent, with inner cone	0.3 mL	11.6 x 32 mm	100	702809
Micro-vial, polypropylene, amber, with inner cone	0.3 mL	11.6 x 32 mm	100	702173
Micro-vial, polypropylene, transparent, with round bottom insert	0.7 mL	11.6 x 32 mm	100	702174

* upon request also available with an integrated silanized glass insert

Ready assembled aluminium crimp closures N 11

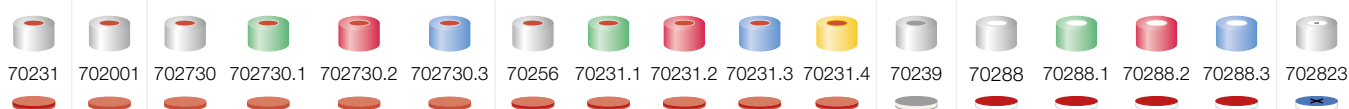

Cap description	Septa description	Thickness	Pack of	REF
N 11 aluminium crimp cap, silver, center hole	Natural rubber / Butyl red-orange / TEF colorless	1.3 mm	100	70231
N 11 aluminium crimp cap, silver, center hole	Natural rubber red-orange / TEF colorless	1.0 mm	100	702001
N 11 aluminium crimp cap, silver, center hole	Red Rubber / FEP colorless	1.0 mm	100	702730
N 11 aluminium crimp cap, green, center hole	as above	1.0 mm	100	702730.1
N 11 aluminium crimp cap, red, center hole	as above	1.0 mm	100	702730.2
N 11 aluminium crimp cap, blue, center hole	as above	1.0 mm	100	702730.3
N 11 aluminium crimp cap, silver, center hole	Natural rubber / Butyl red-orange / TEF colorless	1.0 mm	100	70256
N 11 aluminium crimp cap, green, center hole	as above	1.0 mm	100	70231.1
N 11 aluminium crimp cap, red, center hole	as above	1.0 mm	100	70231.2
N 11 aluminium crimp cap, blue, center hole	as above	1.0 mm	100	70231.3
N 11 aluminium crimp cap, gold, center hole	as above	1.0 mm	100	70231.4
N 11 aluminium crimp cap, silver, center hole	PTFE gray / Butyl beige / PTFE gray	1.3 mm	100	70239
N 11 aluminium crimp cap, silver, center hole	Silicone white / PTFE red	1.3 mm	100	70288
N 11 aluminium crimp cap, green, center hole	as above	1.3 mm	100	70288.1
N 11 aluminium crimp cap, red, center hole	as above	1.3 mm	100	70288.2
N 11 aluminium crimp cap, blue, center hole	as above	1.3 mm	100	70288.3
N 11 aluminium crimp cap, silver, center hole	Silicone white / PTFE blue, cross-slit	1.5 mm	100	702823*

N 11 PE cap, transparent, closed top, with thin piercing area



100

702401

* upon request also available with a green, red or a blue crimp cap



Crimp neck vials and caps N 11

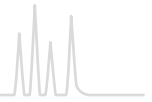

Ordering information

Ready assembled crimp closures N 11



Cap description	Septa description	Thickness	Pack of	REF
N 11 aluminium crimp cap, silver, center hole	PTFE red / Silicone white / PTFE red	1.0 mm	100	702995
N 11 aluminium crimp cap, green, center hole	as above	1.0 mm	100	702995.1
N 11 aluminium crimp cap, red, center hole	as above	1.0 mm	100	702995.2
N 11 aluminium crimp cap, blue, center hole	as above	1.0 mm	100	702995.3
N 11 aluminium crimp cap, silver, center hole	Viton black	1.0 mm	100	702146
N 11 magnetic crimp cap, gold, center hole	Silicone white / PTFE red	1.0 mm	100	702879
N 11 aluminium crimp cap, silver, center hole	PTFE virginal, white	0.25 mm	100	70284
N 11 aluminium crimp cap, silver, roll groove, center hole	O-ring + aluminium septa, TPF (Total Phthalate Free)	0.1 mm	100	702175
N 11 aluminium crimp cap, silver, center hole	no liner	-	100	702801

N 11 Septa for crimp caps N 11

Material	Illustration	Thickness	Pack of	REF
PTFE virginal, white		0.25 mm	100	70262
Red Rubber / FEP colorless		1.0 mm	100	702065

Vial Kits crimp neck N 11

Packs of 100 vials and 100 closures, each

	Closure →			
Vial ↓	70288	702995	70256	702001
70201HP: 1.5 mL, clear, flat bottom	702215	702218	702222	
702885: 1.5 mL, clear, flat bottom, label and scale	702216	702219	702223	702253
702892: 1.5 mL, amber, flat bottom, label and scale	702217	702221	702224	702254

Other Vial Kits on request.



Vial Kit with crimp neck vials and closures N 11

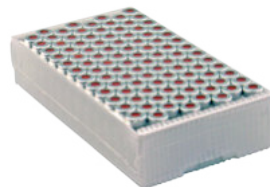

Pre-sealed vial-closure combination



Crimp neck vials and caps N 11



Ordering information

Pre-sealed vial-closure combinations with crimp neck N 11

Vial description	Closure description	Pack of	REF
Pre-sealed vials 70201CG: 1.5 mL crimp neck vial N 11, 11.6 x 32 mm, clear, flat bottom, small opening	crimped with 70256: N 11 aluminium crimp cap, silver, center hole, Natural rubber / Butyl red-orange / TEF colorless, 1.0 mm	100	702881
Pre-sealed vials 70201HP: 1.5 mL crimp neck vial N 11, 11.6 x 32 mm, clear, flat bottom, wide opening	crimped with 70256: N 11 aluminium crimp cap, silver, center hole, Natural rubber / Butyl red-orange / TEF colorless, 1.0 mm	100	702101HP
Pre-sealed vials 702892: 1.5 mL crimp neck vial N 11, 11.6 x 32 mm, amber, flat bottom, wide opening, label and scale	crimped with 70256: N 11 aluminium crimp cap, silver, center hole, Natural rubber / Butyl red-orange / TEF colorless, 1.0 mm	100	702859
Pre-sealed vials 70201HP: 1.5 mL crimp neck vial N 11, 11.6 x 32 mm, clear, flat bottom, wide opening	crimped with 702995: N 11 aluminium crimp cap, silver, center hole, PTFE red / Silicone white / PTFE red, 1.0 mm	100	702867

Other pre-sealed vial-closure combinations on request.

Ordering information

Crimping tools N 11

Description		Pack of	REF
Manual crimper (standard), height adjustable, for 11 mm aluminium crimp caps		1	735111
Manual decapper (standard) for 11 mm aluminium crimp caps		1	735911
Manual decapper (plier style) for 11 mm and 20 mm aluminium crimp caps		1	735911.20
Manual ergonomic crimper for 11 mm aluminium crimp caps		1	735211
Manual ergonomic decapper for 11 mm aluminium crimp caps		1	735311
Electronic crimper for 11 mm aluminium crimp caps (battery-powered)		1	735511
Electronic decapper for 11 mm aluminium crimp caps (battery-powered)		1	735611
Electronic high power crimping tool with power supply		1	735700
Crimping head for 11 mm crimp caps (aluminium, magnetic)		1	735711
Decapping head for 11 mm crimp caps (aluminium, magnetic)		1	735811
Stand for electronic crimping tools		1	735501
Replacement battery 6.6 V, 8.6 Wh for 735511, 735611		1	735500



Snap ring vials and caps N 11

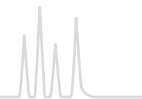

Snap ring vials and caps N 11

★ Key features

- Quick, convenient sealing method which, however, should only be used in HPLC
- Can be used on all common HPLC autosamplers
- Alternatively crimp closures N 11 can be used (see preceding pages).
- 0.3 and 0.7 mL PP snap ring vials for special applications, e.g., for ion chromatography
- Most common closure: with cross-slit Silicone / PTFE septum, which supports easy penetration with the relatively thick, blunt HPLC needle
- Besides hard caps in transparent and blue also more easy to handle soft caps in light blue are available



Ordering information

Snap ring vials N 11, wide opening, and compatible inserts

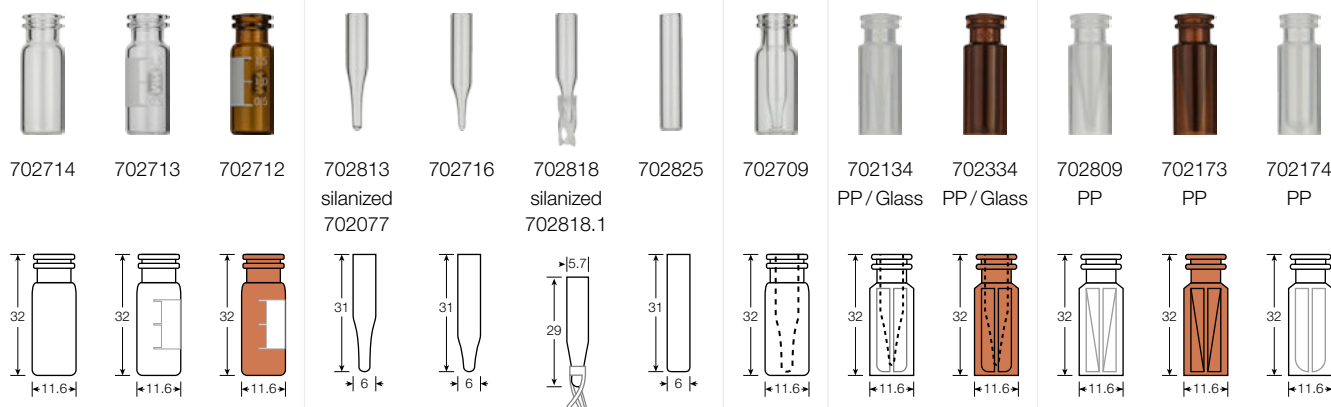

Type of vial	Usable volume	(Illustrations scale 1:2) OD x height	Pack of	REF
Clear, flat bottom	1.5 mL	11.6 x 32 mm	100	702714
Clear, flat bottom, label and scale	1.5 mL	11.6 x 32 mm	100	702713
Amber, flat bottom, label and scale	1.5 mL	11.6 x 32 mm	100	702712
Insert for wide opening vials, clear, conical, 15 mm tip	0.2 mL	6 x 31 mm	100	702813
as above, silanized	0.2 mL	6 x 31 mm	100	702077
Insert for wide opening vials, clear, conical, 12 mm tip	0.25 mL	6 x 31 mm	100	702716
Insert for wide opening vials, clear, with plastic spring	0.1 mL	5.7 x 29 mm	100	702818
as above, silanized	0.1 mL	5.7 x 29 mm	100	702818.1
Insert for wide opening vials, clear, flat bottom	0.3 mL	6 x 31 mm	100	702825
Micro-vial, clear, with integrated 0.2 mL insert	0.2 mL	11.6 x 32 mm	100	702709
Micro-vial, polypropylene, transparent, with integrated 0.2 mL glass-insert, conical	0.2 mL	11.6 x 32 mm	100	702134*
Micro-vial, polypropylene, amber, with integrated 0.2 mL glass-insert, conical	0.2 mL	11.6 x 32 mm	100	702334*
Micro-vial, polypropylene, transparent, with inner cone	0.3 mL	11.6 x 32 mm	100	702809
Micro-vial, polypropylene, amber, with inner cone	0.3 mL	11.6 x 32 mm	100	702173
Micro-vial, polypropylene, transparent, with round bottom insert	0.7 mL	11.6 x 32 mm	100	702174

* upon request also available with an integrated silanized glass insert



Snap ring vials and caps N 11



Pre-assembled vial-insert combinations with snap ring N 11

Vial description	Insert description	Pack of	REF
Vial 702714: 1.5 mL, clear, flat bottom	with pre-assembled micro-insert 702813: 0.2 mL, conical, 15 mm tip	100	702170
Vial 702713: 1.5 mL, clear, flat bottom, label and scale	with pre-assembled micro-insert 702813: 0.2 mL, conical, 15 mm tip	100	702176

Further pre-assembled vial-insert combinations on request.

Ordering information

Ready assembled snap ring closures N 11

Cap description	Septa description	Thickness	Pack of	REF
Hard caps, blue or transparent				
N 11 PE snap ring cap, transparent, center hole	Red Rubber / FEP colorless	1.0 mm	100	702731
N 11 PE snap ring cap, blue, center hole	Red Rubber / FEP colorless	1.0 mm	100	702063
N 11 PE snap ring cap, transparent, center hole	Silicone white / PTFE red	1.0 mm	100	702710
N 11 PE snap ring cap, blue, center hole	Silicone white / PTFE red	1.0 mm	100	702710.1
N 11 PE snap ring cap, transparent, center hole	Silicone white / PTFE blue, cross-slit	1.0 mm	100	702064
N 11 PE snap ring cap, blue, center hole	Silicone white / PTFE blue, cross-slit	1.0 mm	100	702717.2
N 11 PE snap ring cap, transparent, center hole	PTFE red / Silicone white / PTFE red	1.0 mm	100	702718
N 11 PE snap ring cap, blue, center hole	PTFE red / Silicone white / PTFE red	1.0 mm	100	702718.1
Soft caps, light blue				
N 11 PE snap ring cap, soft, light blue, center hole	Red Rubber / FEP colorless	1.0 mm	100	702063.2080
N 11 PE snap ring cap, soft, light blue, center hole	Silicone white / PTFE red	1.0 mm	100	702710.2080
N 11 PE snap ring cap, soft, light blue, center hole	Silicone white / PTFE blue, cross-slit	1.0 mm	100	702717.2080
N 11 PE snap ring cap, soft, light blue, center hole	PTFE red / Silicone white / PTFE red	1.0 mm	100	702718.2080
N 11 PE cap, transparent, closed top, with thin piercing area			100	702401

Vial Kits snap ring N 11

Packs of 100 vials and 100 closures, each

Vial ↓	Closure →			
	702710	702064	702731	702718
702714: 1.5 mL, clear, flat bottom	702225	702228	702232	702235
702713: 1.5 mL, clear, flat bottom, label and scale	702719	702229	702233	702236
702712: 1.5 mL, amber, flat bottom, label and scale	702227	702231	702234	702237

Other Vial Kits on request.





Snap ring vials and caps N 11

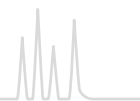

Ordering information

Vial rack for screw neck vials N 8, N 9, N 10 and crimp neck as well as snap ring vials N 11

Description	Pack of	REF
50 position polypropylene vial rack blue, for all vials 11.6 x 32 mm with flat bottom Dimensions: 190 x 100 x 22 mm, stackable	1	702502



Ordering information

Container for screw neck vials N 8, N 9, N 10 and crimp neck as well as snap ring vials N 11

Description	Pack of	REF
81 position container blue, with firmly integrated divider for vials 11.6 x 32 mm, outer length 130 mm, outer width 130 mm, outer height 45 mm, coded, with transparent lid (suitable for freezers)	1	702514



Storage of samples in the fridge or in the freezer

Useful tips for sample handling

Generally sample vials should be stored in a vial container when being placed in the fridge or in the freezer, in order to avoid any condensations on the cap/septa surface that may go along with contaminations in the penetration area of the septa in the center hole. When filling the vial you have to consider the expansion rate of your sample to prevent breakage of the vial. Furthermore it is important to defreeze the sample at a later point in time very slowly (no sudden defreezing with hot water for example). With screw closures you may have to check, if restoring forces have been activated during the defreezing process and if you may have to tighten the screw closure. The choice of the correct closure (septum) depends on the storage temperature.





Special vials for special applications

Silanized glass vials / Plastic vials / Plastic vials with glass insert

- Silanized glass vials

Silanized glass vials have a deactivated inner glass surface, in order to reduce adsorption of polar substances. Therefore they are often used for the analysis of proteins, phenols and amino acids, which would – without any silanization of the glass surface – react with the OH-groups of the glass and thus would stick to the normally polar glass surface. It is also recommendable to use silanized vials respectively inserts for pH-sensitive and aqueous samples.

- Plastic vials

For some applications glass vials are not suitable due their composition and their chemical properties. Amongst these are heavy metal analysis, water and protein analysis, atomic absorption, capillary electrophoresis (CE) and ion chromatography (IC). For all these cases high purity polypropylene vials with 0.3 mL, 0.7 mL and 1.5 ml in transparent and amber are available.

- Plastic vials with glass insert

In comparison to the glass-in-glass products, glass-in-plastic systems are very robust, as the glass insert is well protected by the polypropylene outer shell. The tip of the micro-insert is centered by 100 per cent in an outlet at the bottom. The inserts sit firmly in the protective PP round bottom shell and thus can easily be filled. Another advantage of these systems is their excellent tightness, as the glass insert always constantly exceeds the rim of the plastic outer vial by 0.1 mm granting a firm sealing of the sample in the insert. Upon request also a silanized insert can be integrated into the plastic shell. The high transparent polypropylene enables a good view on the filling level.





Crimp neck vials and caps N 13

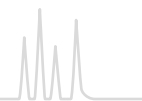

Crimp neck vials and caps N 13



★ Key features

- Usage of these vials and closures is more in the packaging area
- Height adjustable crimpers for aluminium crimp caps as well as for Flip Top / Flip Off crimp caps
- Butyl/PTFE septa with only central PTFE lamination, typically called Pharma-Fix septa, stand out due to their excellent sealing on the glass rims.

Ordering information

Crimp neck vials N 13



70203

Type of vial	Usable volume	(Illustrations scale 1:2) OD x height	Pack of	REF
Clear, flat bottom	2 mL	13.75 x 35 mm	100	70203

Ready assembled crimp closures N 13 and plain crimp caps N 13



70257

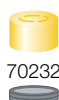

70232



702802

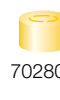

702803

Cap description	Septa description	Thickness	Pack of	REF
N 13 aluminium crimp cap, silver, center hole	Butyl dark gray / PTFE gray*	2 mm	100	70257
N 13 aluminium center tear off cap, gold	Butyl dark gray / PTFE gray*	2 mm	100	70232
N 13 aluminium crimp cap, silver, center hole	no liner	–	100	702802
N 13 aluminium center tear off cap, gold	no liner	–	100	702803

* only centrally laminated, typically called Pharma-Fix

Crimping tools N 13

Description	Pack of	REF
Manual crimper (standard), height adjustable, for 13 mm aluminium crimp caps	1	735113
Manual crimper (standard), height adjustable, for 13 mm Flip Top / Flip Off caps	1	735133
Manual decapper (standard) for 13 mm aluminium crimp caps	1	735913

Container for crimp and screw neck vials N 13

Description	Pack of	REF
49 position container blue, with firmly integrated divider, for crimp and screw neck vials N 13, outer length 130 mm, outer width 130 mm, outer height 50 mm, with transparent lid (suitable for freezers)	1	702515

Vial rack for crimp and screw neck vials N 13

Description	Pack of	REF
50 position polypropylene vial rack blue, for all vials with a diameter of 15 mm max. and flat bottom Dimensions: 240 x 120 x 28 mm, stackable	1	702504



Container for crimp and screw neck vials N 13



Vial rack for crimp and screw neck vials N 13



Screw neck vials and caps N 13



★ Key features

- Generally used for large sample volumes in HPLC
- In combination with closed top screw closures suitable for sample storage (see pages 120–122)
- Compatible insert requires metal spring for central alignment
- Range of ready assembled closures and plain caps with center hole or with closed top as well as separate septa (PTFE virginal, Red Rubber / FEP and Silicone / PTFE) are available.

Ordering information

Screw neck vials N 13 (13-425 thread) and compatible insert

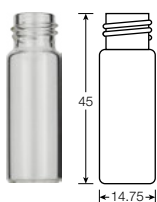

702962

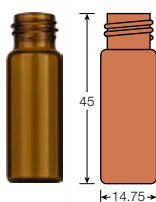

702973

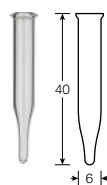

702972



702974

Type of vial	Usable volume	OD x height	Pack of	REF
Clear, flat bottom	4 mL	14.75 x 45 mm	100	702962
Amber, flat bottom	4 mL	14.75 x 45 mm	100	702973
Insert, clear, conical, metal spring required	0.3 mL	6 x 40 mm	100	702972
Metal spring for 702972	–	–	100	702974

(Illustrations scale 1:2)

Ready assembled screw closures and plain screw caps N 13



702103



702050



702051



702926



702052



702963



702966

Cap description	Septa description	Thickness	Pack of	REF
N 13 screw cap (13-425), green, closed top	F217 white / PTFE beige (firmly fixed)	1.5 mm	100	702103
N 13 PP screw cap, black, center hole	Red Rubber / FEP colorless	1.5 mm	100	702050
as above, but with closed top	Red Rubber / FEP colorless	1.5 mm	100	702051
N 13 PP screw cap, black, center hole	Silicone white / PTFE red	1.3 mm	100	702926
as above, but with closed top	Silicone white / PTFE red	1.3 mm	100	702052
N 13 PP screw cap, black, center hole	no liner	–	100	702963
as above, but with closed top	no liner	–	100	702966

N 12 septa for screw caps N 13

Material	Illustration	Thickness	Pack of	REF
PTFE virginal, white		0.25 mm	100	70260
Red Rubber / FEP colorless		1.5 mm	100	702053
Silicone white / PTFE red		1.3 mm	100	702292

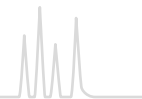

Screw neck vials for storage of liquid samples



★ Key features

- Usable volumes of 1.5 up to 24 mL
- Available neck sizes N 8, N 9, N 13, N 15, N 18 and N 20
- Corresponding closed top screw closures with different septa materials

Ordering information



70213



70213.2



702004



702893



702068



702066

Screw neck vials N 8, small opening (8-425 thread)

Type of vial	Usable volume	(Illustrations scale 1:2) OD x height	Pack of	REF
Clear, flat bottom	1.5 mL	11.6 x 32 mm	100	70213
Amber, flat bottom	1.5 mL	11.6 x 32 mm	100	70213.2
Clear, flat bottom, label and scale	1.5 mL	11.6 x 32 mm	100	702004
Amber, flat bottom, label and scale	1.5 mL	11.6 x 32 mm	100	702893

Closed top screw closures N 8

Cap description	Septa description	Thickness	Pack of	REF
N 8 PP screw cap, black, closed top	Red Rubber / FEP colorless	1.3 mm	100	702068
N 8 PP screw cap, black, closed top	Silicone white / PTFE red	1.3 mm	100	702066

Ordering information

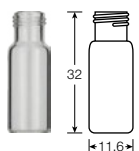

702282



702293



702283

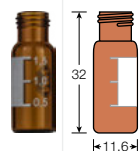

702284



702032



702033



702034

Screw neck vials N 9, wide opening (short thread)

Type of vial	Usable volume	(Illustrations scale 1:2) OD x height	Pack of	REF
Clear, flat bottom	1.5 mL	11.6 x 32 mm	100	702282
Amber, flat bottom	1.5 mL	11.6 x 32 mm	100	702293
Clear, flat bottom, label and scale	1.5 mL	11.6 x 32 mm	100	702283
as above, silanized	1.5 mL	11.6 x 32 mm	100	702078
Amber, flat bottom, label and scale	1.5 mL	11.6 x 32 mm	100	702284
as above, silanized	1.5 mL	11.6 x 32 mm	100	702079

Closed top screw closures N 9

Cap description	Septa description	Thickness	Pack of	REF
N 9 PP screw cap blue, closed top	PTFE virginal, white	0.25 mm	100	702032
N 9 PP screw cap blue, closed top	Red Rubber / FEP colorless	1.0 mm	100	702033
N 9 PP screw cap blue, closed top	Silicone white / PTFE red	1.0 mm	100	702034



Ordering information



702962

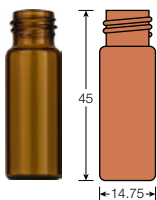

702973

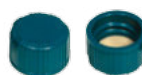

702103



702051



702052

Screw neck vials N 13 (13-425 thread)

Type of vial	Usable volume	(Illustrations scale 1:2) OD x height	Pack of	REF
Clear, flat bottom	4 mL	14.75 x 45 mm	100	702962
Amber, flat bottom	4 mL	14.75 x 45 mm	100	702973

Closed top screw closures N 13

Cap description	Septa description	Thickness	Pack of	REF
N 13 screw cap (13-425), green, closed top	F217 white / PTFE beige (firmly fixed)	1.5 mm	100	702103
N 13 PP screw cap, black, closed top	Red Rubber / FEP colorless	1.5 mm	100	702051
N 13 PP screw cap, black, closed top	Silicone white / PTFE red	1.3 mm	100	702052

Ordering information

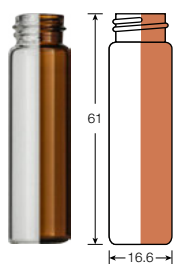

702096 / 702311

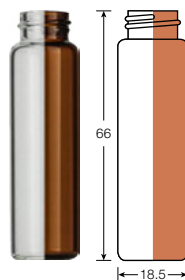

70285 / 702097



702104



702180

Screw neck vials N 15 (15-425 thread)

Type of vial	Usable volume	(Illustrations scale 1:2) OD x height	Pack of	REF
Screw neck vial N 15 (15-425 thread), clear, flat bottom	8 mL	16.6 x 61 mm	100	702096
Screw neck vial N 15 (15-425 thread), amber, flat bottom	8 mL	16.6 x 61 mm	100	702311
Screw neck vial N 15 (15-425 thread), clear, flat bottom	12 mL	18.5 x 66 mm	100	70285
Screw neck vial N 15 (15-425 thread), amber, flat bottom	12 mL	18.5 x 66 mm	100	702097

Screw closures N 15

Cap description	Septa description	Thickness	Pack of	REF
N 15 screw cap (15-425), green, closed top	F217 white / PTFE beige (firmly fixed)	1.5 mm	100	702104
N 15 PP bonded screw cap (15-425), black, center hole	Silicone white / PTFE beige	1.5 mm	100	702180

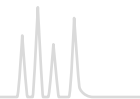

Ordering information

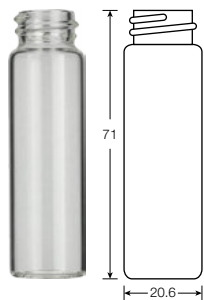

702098



702105

Screw neck vial N 18 (18-400 thread)

Type of vial	Usable volume	(Illustrations scale 1:2) OD x height	Pack of	REF
Screw neck vial N 18 (18-400 thread), clear, flat bottom	16 mL	20.6 x 71 mm	100	702098

Screw closures N 18

Cap description	Septa description	Thickness	Pack of	REF
N 18 screw cap (18-400), green, closed top	F217 white / PTFE beige (firmly fixed)	1.5 mm	100	702105

Ordering information

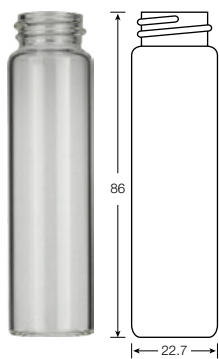

702099



702106



702181

Screw neck vials N 20 (20-400 thread)

Type of vial	Usable volume	(Illustrations scale 1:2) OD x height	Pack of	REF
Screw neck vial N 20 (20-400 thread), clear, flat bottom	24 mL	22.7 x 86 mm	100	702099

Screw closures N 20

Cap description	Septa description	Thickness	Pack of	REF
N 20 screw cap (20-400), green, closed top	F217 white / PTFE beige (firmly fixed)	1.5 mm	100	702106
N 20 PP bonded screw cap (20-400), white, center hole	Silicone white / PTFE beige	1.5 mm	100	702181

For screw neck vials with even larger volumes please see page 131.



Snap cap vials for storage of powdery samples



★ Key features

- Available sizes N 18 and N 22
- Usable volumes from 5 up to 25 mL
- Glass of 3rd hydrolytic class

Ordering information



70271



70272



70274

Snap cap vials N 18

Type of vial	Usable volume	(Illustrations scale 1:2) OD x height	Pack of	REF
N 18, clear, flat bottom	5 mL	20 x 40 mm	100	70271
N 18, clear, flat bottom	10 mL	22 x 50 mm	100	70272

PE snap caps N 18

Description	Pack of	REF
N 18 PE snap cap, transparent, for 70271 and 70272	100	70274

Ordering information



702019



70273



70275

Snap cap vials N 22

Type of vial	Usable volume	(Illustrations scale 1:2) OD x height	Pack of	REF
N 22, clear, flat bottom	15 mL	26 x 48 mm	100	702019
N 22, clear, flat bottom	25 mL	26 x 65 mm	100	70273

PE snap caps N 22

Description	Pack of	REF
N 22 PE snap cap, transparent, for 702019 and 70273	100	70275

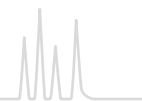

Shell vials N 8 and N 12

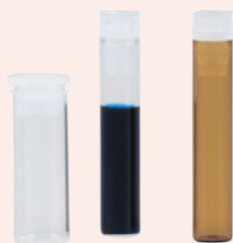

★ Key features

- Economic combination of vials and closures for uncritical HPLC applications
- PE stoppers with a diaphragm for safe penetration of the needle
- Often used on Waters® and Shimadzu® instruments

Ordering information

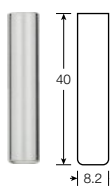

70202.1

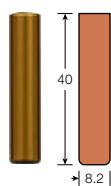

702017



702807

Shell vials N 8 with PE plug

Type of vial	Usable volume	(Illustrations scale 1:2) OD x height	Pack of	REF
N 8, clear, flat bottom	1 mL	8.2 x 40 mm	100	70202.1
N 8, amber, flat bottom	1 mL	8.2 x 40 mm	100	702017

PE plug N 8

Description	Pack of	REF
N 8 PE plug, transparent, for 70202.1 and 702017	100	702807

Ordering information

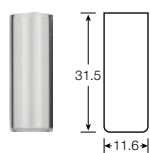

702018



702054

Shell vials N 12 with PE plug

Type of vial	Usable volume	(Illustrations scale 1:2) OD x height	Pack of	REF
N 12, clear, flat bottom	2 mL	11.6 x 31.5 mm	100	702018

PE plug N 12

Description	Pack of	REF
N 12 PE plug, transparent, for 702018	100	702054



Screw neck vials and magnetic screw caps N 18



★ Key features

- Headspace vials for convenient, safe and consistent handling
- High tightness and better reproducibility of the sealing process (as compared to crimping)
- Thinner septum (1.5 mm instead of 3 mm septum thickness in crimp caps), thus safe penetration of the needle and less fragmentation (especially important for SPME applications)
- Improved run in autosamplers with magnets (CTC Combi PAL and equivalent instruments), since a flat surface for the magnet is ensured, thus avoiding that the filled vial can drop from the magnet

Ordering information



Headspace screw neck vials N 18

Type of vial	Usable volume	(Illustrations scale 1:2) OD x height	Pack of	REF
Clear, rounded bottom	10 mL	22.5 x 46.0 mm	100	702866
Clear, rounded bottom	20 mL	22.5 x 75.5 mm	100	702826
Amber, rounded bottom	20 mL	22.5 x 75.5 mm	100	702826.2

Ready assembled, magnetic screw closures N 18

Cap description	Septa description	Thickness	Pack of	REF
N 18 magnetic screw cap, silver, center hole	Silicone blue transparent / PTFE white	1.5 mm	100	702827
N 18 magnetic screw cap, silver, center hole	Silicone white / PTFE blue	1.5 mm	100	702055
N 18 magnetic screw cap, silver, center hole	Silicone white / PTFE blue, slit	1.5 mm	100	702136
N 18 magnetic screw cap, silver, center hole	Red Rubber / TEF colorless	1.5 mm	100	702072

N 17 septa for magnetic screw caps N 18

Material	Illustration	Thickness	Pack of	REF
Silicone blue transparent / PTFE white		1.5 mm	100	702981
Silicone white / PTFE blue		1.5 mm	100	702110

Container for screw neck vials N 18 and crimp neck vials N 20

Description	Pack of	REF
25 position container blue, with removable divider, for headspace screw neck vials N 18 and crimp neck vials N 20; outer length 130 mm, outer width 130 mm, outer height 80 mm, with transparent lid (suitable for freezers)	1	702516



Crimp neck vials and caps N 20

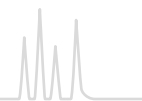

Crimp neck vials and caps N 20



★ Key features

- Large range of Headspace crimp neck vials with different volumes and diameters
- Flat DIN crimp neck with stable bearing surface for the septum (especially suited for high vial pressures) as well as beveled HS crimp neck for instruments of certain manufacturers (PerkinElmer®).
- Assignment to respective instrument manufacturers in parentheses
- Different types of crimp closures depending on instrument and application
- Please consider our various crimping tools on pages 134-135.

Ordering information

Crimp neck vials N 20 (volume 5–10 mL)



70204.36

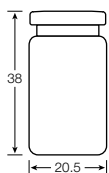

70215.36

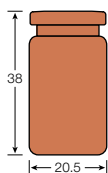

702917

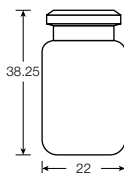

702020

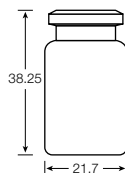

70205.36

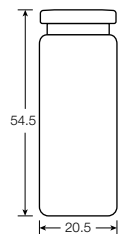

70216.36

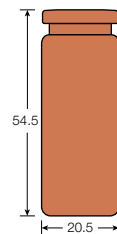

702918

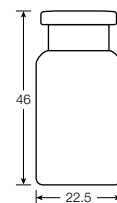

702924

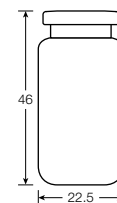

Type of vial	Usable volume	OD x height	Pack of	REF
Clear, flat bottom, flat DIN crimp neck (Varian®)	5 mL	20.5 x 38.0 mm	100	70204.36
Amber, flat bottom, flat DIN crimp neck (Varian®)	5 mL	20.5 x 38.0 mm	100	70215.36
Clear, rounded bottom, beveled HS crimp neck (PerkinElmer®)	6 mL	22.0 x 38.25 mm	100	702917
Clear, flat bottom, beveled HS crimp neck (Metrohm®, Karl-Fischer titration)	5 mL	21.7 x 38.25 mm	100	702020
Clear, flat bottom, flat DIN crimp neck (Varian®)	10 mL	20.5 x 54.5 mm	100	70205.36
Amber, flat bottom, flat DIN crimp neck (Varian®)	10 mL	20.5 x 54.5 mm	100	70216.36
Clear, flat bottom, flat DIN crimp neck (Dani, Agilent®)	10 mL	22.5 x 46.0 mm	100	702918
Clear, rounded bottom, flat DIN crimp neck (CTC)	10 mL	22.5 x 46.0 mm	100	702924

Container for screw neck vials N 18 and crimp neck vials N 20

Description	Pack of	REF
25 position container blue, with removable divider, for headspace screw neck vials N 18 and crimp neck vials N 20; outer length 130 mm, outer width 130 mm, outer height 80 mm, with transparent lid (suitable for freezers)	1	702516



Crimp neck vials and caps N 20



Ordering information

Crimp neck vials N 20 (volume 20 mL)

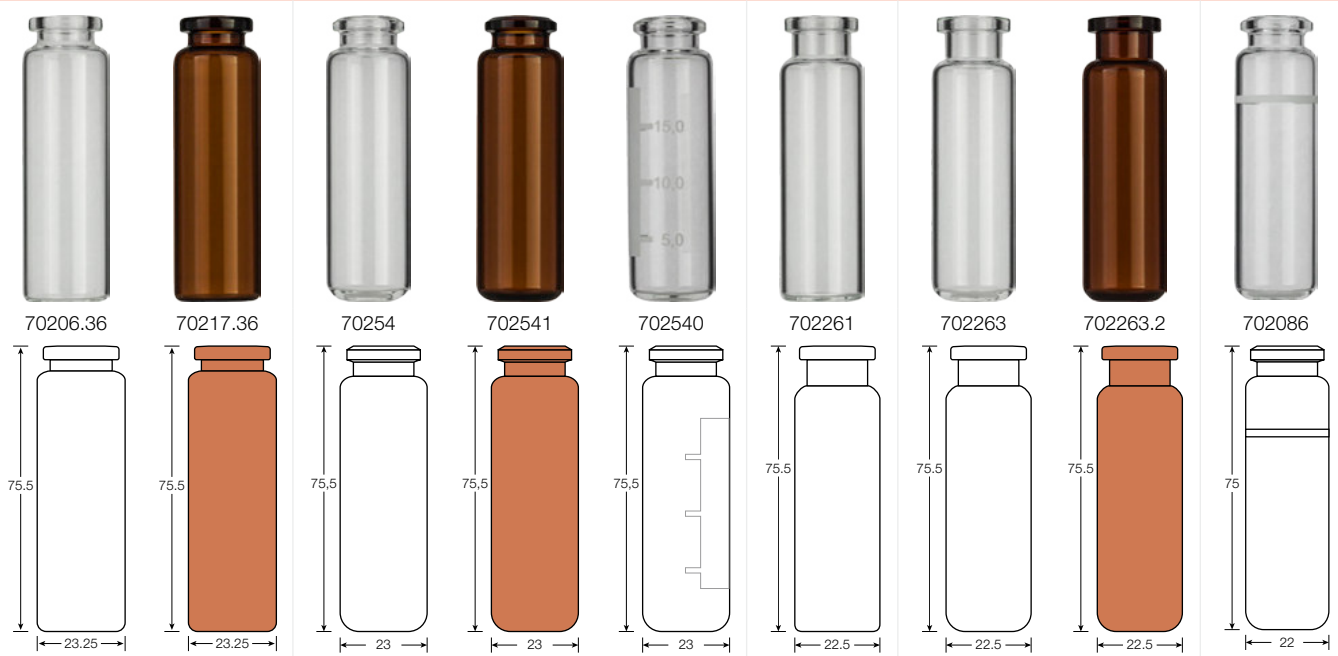

(Illustrations scale 1:2)				
Type of vial	Usable volume	OD x height	Pack of	REF
Clear, flat bottom, flat DIN crimp neck	20 mL	23.25 x 75.5 mm	100	70206.36
Amber, flat bottom, flat DIN crimp neck	20 mL	23.25 x 75.5 mm	100	70217.36
Clear, rounded bottom, beveled HS crimp neck (PerkinElmer®)	20 mL	23.0 x 75.5 mm	100	70254
Amber, rounded bottom, beveled HS crimp neck (PerkinElmer®)	20 mL	23.0 x 75.5 mm	100	702541
Clear, rounded bottom, beveled HS crimp neck, label (PerkinElmer®)	20 mL	23.0 x 75.5 mm	100	702540
Clear, flat bottom, flat DIN crimp neck (Dani, Agilent®)	20 mL	22.5 x 75.5 mm	100	702261
Clear, rounded bottom, flat DIN crimp neck (CTC)	20 mL	22.5 x 75.5 mm	100	702263
Amber, rounded bottom, flat DIN crimp neck (CTC)	20 mL	22.5 x 75.5 mm	100	702263.2
Clear, rounded bottom, beveled HS crimp neck, graduation at 15 mL	20 mL	22.0 x 75.0 mm	100	702086



Crimp neck vials and caps N 20

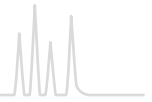

Ordering information

Crimp neck vials N 20 (volume > 20 mL)

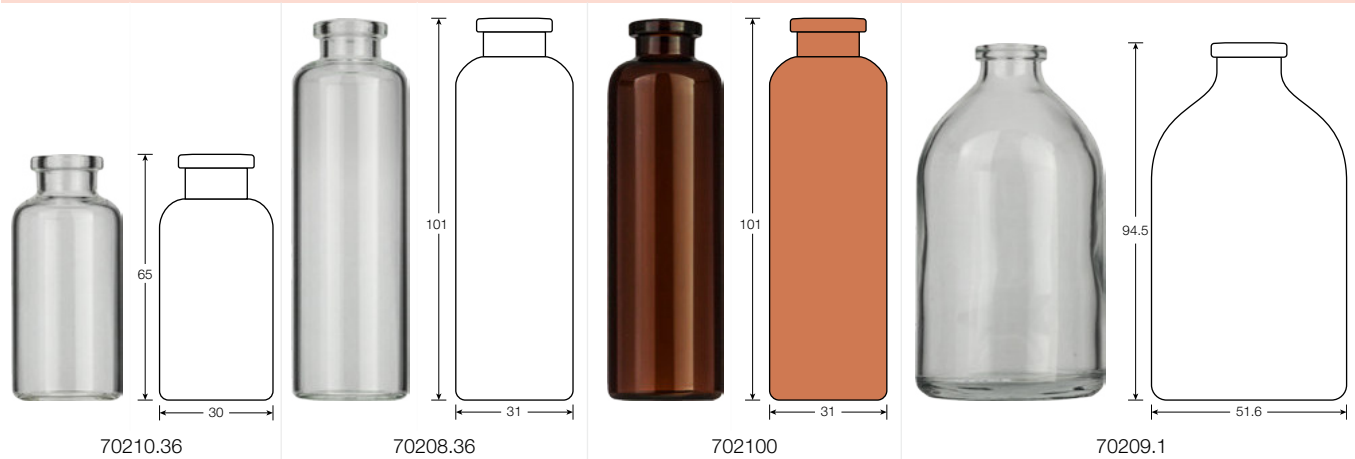

(Illustrations scale 1:2)

Type of vial	Usable volume	OD x height	Pack of	REF
Clear, flat bottom, flat DIN crimp neck	25 mL	30 x 65 mm	100	70210.36
Clear, flat bottom, flat DIN crimp neck	50 mL	31 x 101 mm	100	70208.36
Amber, flat bottom, flat DIN crimp neck	50 mL	31 x 101 mm	100	702100
Clear, flat bottom, flat DIN crimp neck (3 rd hydrolytic class)	100 mL	51.6 x 94.5 mm	60	70209.1

Ordering information

Crimping tools N 20

Description		Pack of	REF
Manual crimper (standard), height adjustable, for 20 mm aluminium crimp caps		1	735120
Manual crimper (standard), height adjustable, for 20 mm Flip Top / Flip Off caps		1	735132
Manual decapper (standard) for 20 mm aluminium crimp caps		1	735920
Manual decapper (plier style, dual) for 11 mm and 20 mm aluminium crimp caps		1	735911.20
Manual ergonomic crimper for 20 mm aluminium crimp caps		1	735220
Manual ergonomic decapper for 20 mm aluminium crimp caps		1	735320
Electronic crimper for 20 mm aluminium crimp caps (battery-powered)		1	735520
Electronic decapper for 20 mm aluminium crimp caps (battery-powered)		1	735620
Electronic high power crimping tool with power supply		1	735700
Crimping head for 20 mm crimp caps (aluminium, magnetic, bi-metal)		1	735720
Decapping head for 20 mm crimp caps (aluminium, magnetic, bi-metal)		1	735820
Stand for electronic crimping tools		1	735501
Replacement battery 6.6 V, 8.6 Wh for 735520, 735620		1	735500

Crimp neck vials and caps N 20



Ordering information

Ready assembled crimp closures N 20

Center hole caps



Cap description	Septa description	Thickness	Pack of	REF
N 20 aluminium crimp cap, silver, center hole	Butyl red / PTFE gray	3 mm	100	702773
N 20 aluminium crimp cap, silver, center hole	Butyl light gray / PTFE dark gray	3 mm	100	702775
N 20 aluminium crimp cap, silver, center hole	Molded septum Butyl / PTFE gray	3 mm	100	70234.9
N 20 aluminium crimp cap, silver, center hole	Butyl dark gray / PTFE gray*	3 mm	100	70234
N 20 aluminium crimp cap, silver, center hole	Butyl dark gray / PTFE gray*, high purity	3 mm	100	70234.10
N 20 aluminium crimp cap, gold, center hole	Butyl dark gray / PTFE gray*	3 mm	100	702056
N 20 aluminium crimp cap, silver, center hole	Butyl stopper gray, unassembled (separate parts)	–	100 each	70237
N 20 aluminium crimp cap, silver, center hole	Silicone blue transp. / PTFE colorless	3 mm	100	702093
N 20 aluminium crimp cap, silver, center hole	Silicone white / PTFE beige	3 mm	100	702094
N 20 aluminium crimp cap, silver, center hole	Silicone white / PTFE red (economy line)	3 mm	100	702091
N 20 aluminium crimp cap, silver, center hole	Silicone white / FEP-/Aluminium foil silver	3.2 mm	100	702145
N 20 aluminium crimp cap, silver, center hole	no liner	–	100	702804
N 20 aluminium crimp cap, gold, center hole	no liner	–	100	702112

Pressure release caps



Cap description	Septa description	Thickness	Pack of	REF
N 20 aluminium pressure release cap, silver, center hole	Butyl red / PTFE gray	3 mm	100	702836
N 20 aluminium pressure release cap, silver, center hole	Butyl light gray / PTFE dark gray	3 mm	100	702829
N 20 aluminium pressure release cap, silver, center hole	Molded septum Butyl / PTFE gray	3 mm	100	70234.8
N 20 aluminium pressure release cap, silver, center hole	Butyl dark gray / PTFE gray*	3 mm	100	702071
N 20 aluminium pressure release cap, silver, center hole	Silicone blue transp. / PTFE colorless	3 mm	100	702927
N 20 aluminium pressure release cap, silver, center hole	Silicone white / PTFE beige	3 mm	100	702835
N 20 aluminium pressure release cap, silver, center hole	no liner	–	100	702799

Bi-metal crimp caps

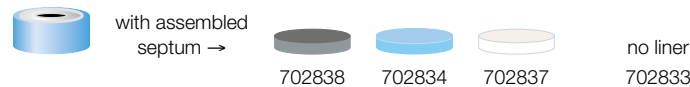

Cap description	Septa description	Thickness	Pack of	REF
N 20 Bi-metal crimp cap, blue / silver, center hole	Butyl light gray / PTFE dark gray	3 mm	100	702838
N 20 Bi-metal crimp cap, blue / silver, center hole	Silicone blue transp. / PTFE colorless	3 mm	100	702834
N 20 Bi-metal crimp cap, blue / silver, center hole	Silicone white / PTFE beige	3 mm	100	702837
N 20 Bi-metal crimp cap, blue / silver, center hole	no liner	–	100	702833

Magnetic crimp caps



Cap description	Septa description	Thickness	Pack of	REF
N 20 magnetic crimp cap, silver, 8 mm center hole	Butyl red / PTFE gray	3 mm	100	702774
N 20 magnetic crimp cap, silver, 8 mm center hole	Butyl light gray / PTFE dark gray	3 mm	100	702928
N 20 magnetic crimp cap, silver, 8 mm center hole	Butyl dark gray / PTFE gray*	3 mm	100	702928.9
N 20 magnetic crimp cap, silver, 8 mm center hole	Silicone blue transp. / PTFE colorless	3 mm	100	702929
N 20 magnetic crimp cap, silver, 8 mm center hole	no liner	–	100	702808

* only centrally laminated with PTFE, typically called Pharma-Fix







Crimp neck vials and caps N 20







Ordering information

Ready assembled crimp closures N 20







Center tear off caps

		70233			70236		no liner	70236.1
Cap description			Septa description		Thickness	Pack of	REF	
N 20 aluminium center tear off cap, gold			Butyl dark gray / PTFE gray*		3 mm	100	70233	
N 20 aluminium center tear off cap, silver			Butyl stopper gray, unassembled (separate parts)		–	100 each	70236	
N 20 aluminium center tear off cap, silver			no liner		–	100	70236.1	

Complete tear off caps



		70235			70238		no liner	702805
Cap description			Septa description		Thickness	Pack of	REF	
N 20 aluminium complete tear off cap, silver			Butyl dark gray / PTFE gray*		3 mm	100	70235	
N 20 aluminium complete tear off cap, silver			Butyl stopper gray, unassembled (separate parts)		–	100 each	70238	
N 20 aluminium complete tear off cap, silver			no liner		–	100	702805	

N 20 septa for crimp caps N 20

Material	Illustration	Thickness	Pack of	REF
Butyl red / PTFE gray		3 mm	100	70277
Butyl light gray / PTFE dark gray		3 mm	100	702057
Molded septum Butyl / PTFE gray		3 mm	100	702101
Butyl dark gray / PTFE gray*		3 mm	100	702D20TB
Silicone blue transparent / PTFE colorless		3 mm	100	702780
Silicone white / PTFE beige		3 mm	100	70278
Silicone white / Aluminium foil silver		3 mm	100	70279





* only centrally laminated, typically called Pharma-Fix

Stoppers N 20



Material	Illustration	Pack of	REF
Butyl gray		100	702931
Bromobutyl red		100	702931.1

Ordering information

PE caps N 20

height 8.4 mm		70266		702128	height 9.1 mm		70267		702129
Description					Pack of	REF			
N 20 PE cap, transparent, for beveled HS crimp neck N 20, 4.3 mm center hole (no liner)					100	70266			
as above, but with septum Butyl beige / PTFE gray, unassembled, 1.3 mm					100	70242			
as above, but with assembled septum natural rubber red-orange / TEF colorless, 1.3 mm					100	702128			
N 20 PE cap, transparent, for flat DIN crimp neck N 20, 4.3 mm center hole (no liner)					100	70267			
as above, but with septum Butyl beige / PTFE gray, unassembled, 1.3 mm					100	70240			
as above, but with assembled septum natural rubber red-orange / TEF colorless, 1.3 mm					100	702129			

N 19 septa for PE caps N 20

Description	Illustration	Thickness	Pack of	REF
Butyl beige / PTFE gray		1.3 mm	100	70269
Natural rubber red-orange / TEF colorless		1.3 mm	100	702904
Silicone blue transparent / PTFE white		1.3 mm	100	702144



Screw neck vials and caps N 24 (EPA)



★ Key features

- Recommended for VOC and TOC analyses
- Closed top screw closures for sample storage
- Most frequently used: 40 mL clear glass
- Often called EPA vials, since they are defined in the regulations of the US Environmental Protection Agency
- Due to their size mainly used as bonded closure for a firm fit of the septum
- Recommended for environmental analysis: screw closure with center hole and Silicone / PTFE septum
- Universal screw closure 702168 with removable protection lid for sample storage and analysis

Ordering information

Screw neck vials N 24 (EPA)

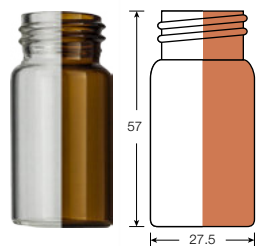

702021 / 702022

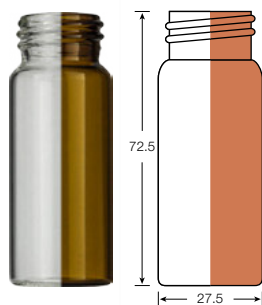

702132 / 702133

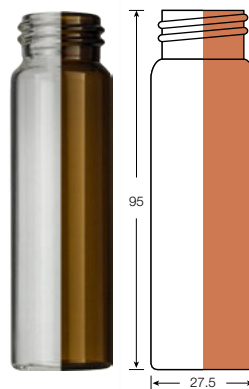

702023 / 702024

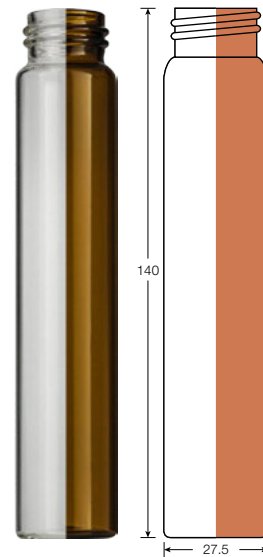

702074 / 702131

Type of vial	Usable volume	(Illustrations scale 1:2) OD x height		Pack of	REF
Clear, flat bottom	20 mL	27.5 x 57.0 mm		100	702021
Amber, flat bottom	20 mL	27.5 x 57.0 mm		100	702022
Clear, flat bottom	30 mL	27.5 x 72.5 mm		100	702132
Amber, flat bottom	30 mL	27.5 x 72.5 mm		100	702133
Clear, flat bottom	40 mL	27.5 x 95.0 mm		100	702023
Amber, flat bottom	40 mL	27.5 x 95.0 mm		100	702024
Clear, flat bottom	60 mL	27.5 x 140 mm		100	702074
Amber, flat bottom	60 mL	27.5 x 140 mm		100	702131

Container for screw neck vials N 24

Description	Pack of	REF
16 position container blue, with removable divider, for screw neck vials N 24 (20 mL, 30 mL, 40 mL); outer length 130 mm, outer width 130 mm, outer height 102 mm, with transparent lid (suitable for freezers)	1	702517



Screw neck vials and caps N 24

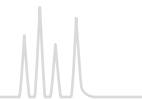

Ordering information

Screw closures N 24 and plain screw caps N 24



Cap description	Septa description	Thickness	Pack of	REF
N 24 PP bonded* screw cap, white, center hole	Silicone white / PTFE beige	3.2 mm	100	702058
as above, but with closed top	Silicone white / PTFE beige	3.2 mm	100	702059
N 24 PP bonded* screw cap, white, center hole	Red Rubber / TEF colorless	2.5 mm	100	702073
N 24 PP bonded* screw cap, white, center hole, with removable protection lid	Silicone natural / PTFE colorless	3.2 mm	100	702168
N 24 PP screw cap, white, center hole	Butyl red / PTFE gray	2.4 mm	100	702130
as above, but with closed top	Butyl red / PTFE gray	2.4 mm	100	702102
N 24 PP screw cap, white, center hole	no liner		100	702060
as above, but with closed top	no liner		100	702061

* septum firmly connected with the cap, cannot be removed

Septa N 22 for screw caps N 24

Material	Illustration	Thickness	Pack of	REF
Silicone natural / PTFE colorless		3.2 mm	100	702062
Butyl red / PTFE gray		2.4 mm	100	702791

Ordering information

Pre-sealed vial-closure combinations with screw neck N 24

Vial description	Closure description	Pack of	REF
Pre-sealed vials 702021: 20 mL screw neck vial N 24, 27.5 x 57 mm, clear, flat bottom	pre-screwed with 702073: N 24 PP bonded screw cap, white, center hole, Red rubber / TEF colorless, 45° shore A, 2.5 mm	100	702865
Pre-sealed vials 702023: 40 mL screw neck vial N 24, 27.5 x 95 mm, clear, flat bottom	pre-screwed with 702058: N 24 PP bonded screw cap, white, center hole, Silicone white / PTFE beige, 45° shore A, 3.2 mm	100	702877

Other pre-sealed vial-closure combinations on request.



Universal screw closure N 24

All-in-one closure for sample storage and analysis, REF 702168

- Fits on all screw neck vials N 24 (EPA)
- Removable protection lid covers the penetration area and thus keeps the septa dust and contamination free
- Bonded Silicone / PTFE septa for safe penetration (septum is firmly connected to the screw cap)
- Ultrapure, soft Silicone / PTFE septa material prevents ghost peaks in the analysis
- Protection lid can repeatedly be removed and put on again





Containers



★ Key features

- Allow a secure transportation of sample vials
- Safe standing position in dividers designed for the respective diameter
- Ideal for space-saving storage in fridges, since the transparent lid prevents condensations on the closures and thus avoids a possible contamination in the cooling unit
- Available for all 1.5 mL vials (standard volume), for crimp and screw neck vials N 13 and for headspace vials with screw neck N 18 or crimp neck N 20, respectively as well as for EPA screw neck vials N 24

Ordering information

Containers

Description	Pack of	REF
81 position container blue, with integrated divider for all vials 11.6 x 32 mm outer length 130 mm, outer width 130 mm, outer height 45 mm, coded, with transparent lid (suitable for freezers)	1	702514
49 position container blue, with integrated divider for crimp and screw neck vials N 13; outer length 130 mm, outer width 130 mm, outer height 50 mm, with transparent lid (suitable for freezers)	1	702515
25 position container blue, with removable divider for headspace screw neck vials N 18 and crimp neck vials N 20; outer length 130 mm, outer width 130 mm, outer height 80 mm, with transparent lid (suitable for freezers)	1	702516
16 position container blue, with removable divider for screw neck vials N 24 (20 mL, 30 mL, 40 mL); outer length 130 mm, outer width 130 mm, outer height 102 mm, with transparent lid (suitable for freezers)	1	702517

Ordering information

Vial racks

Description	Pack of	REF
50 position polypropylene vial rack blue, for all vials 11.6 x 32 mm with flat bottom Dimensions: 190 x 100 x 22 mm, stackable	1	702502
50 position polypropylene vial rack blue, for all vials with a diameter of 15 mm max. and flat bottom Dimensions: 240 x 120 x 28 mm, stackable	1	702504



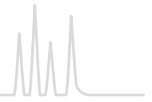

Manual crimping tools

Advanced ergonomic version



Crimper available for 8 mm, 11 mm and 20 mm crimp caps

- More lightweighted than complete steel crimpers
- Ergonomically designed handles
- Adjustment by a knob on the crimping head that is easily accessible and visible
- Activated by bottom handle motion only which allows a steadier and safer hold of the tool during crimping
- Due to design and alignment of the crimping head better vertical clearance over the vial

Advanced ergonomic decappers allow safe removal of caps; no adjustment required (for 11 and 20 mm crimp caps available)

Standard version



Crimper available for 8, 11, 13 and 20 mm crimp caps

- Adjustable crimping height via hexagon key, which allows to move the inner part of the crimping head up and down (not possible for manual crimpers N 8)
- Crimping pressure adjustable via screw in the handle
- Manual crimpers for N 13 and N 20 Flip Top / Flip Off caps (pharmaceutical closures) available
- Long life time and convenient handling

Manual decappers (standard version) allow safe removal of caps; no adjustment required

Ordering information

Description	Pack of	REF
Manual crimpers (ergonomic)		
(crimping pressure adjustable by knob on the crimping head)		
Manual ergonomic crimper for 8 mm aluminium crimp caps	1	735208
Manual ergonomic crimper for 11 mm aluminium crimp caps	1	735211
Manual ergonomic crimper for 20 mm aluminium crimp caps	1	735220
Manual decappers (ergonomic)		
Manual ergonomic decapper for 11 mm aluminium crimp caps	1	735311
Manual ergonomic decapper for 20 mm aluminium crimp caps	1	735320
Manual crimpers (standard)		
Crimping height: adjustable by a hexagon key in the crimping head		
Crimping pressure: adjustable by a screw in the handle		
Manual crimper for 8 mm aluminium crimp caps	1	735126
Manual crimper, height adjustable, for 11 mm aluminium crimp caps	1	735111
Manual crimper, height adjustable, for 13 mm aluminium crimp caps	1	735113
Manual crimper, height adjustable, for 13 mm Flip Top / Flip Off crimp caps	1	735133
Manual crimper, height adjustable, for 20 mm aluminium crimp caps	1	735120
Manual crimper, height adjustable, for 20 mm Flip Top / Flip Off crimp caps	1	735132
Manual decappers (standard)		
Manual decapper for 8 mm aluminium crimp caps	1	735408
Manual decapper for 11 mm aluminium crimp caps	1	735911
Manual decapper for 13 mm aluminium crimp caps	1	735913
Manual decapper for 20 mm aluminium crimp caps	1	735920
Manual decapper (plier style) for two cap sizes		
Manual decapper, for 11 mm and 20 mm crimp caps	1	735911.20



Electronic crimping tools

Battery-powered electronic crimping tools



Available for 11 mm and 20 mm aluminium crimp caps (not suitable for 20 mm magnetic / bi-metal crimp caps). Mobile tools for consistent and reproducible crimping results

- Crimping pressure adjustable by pushing +/- buttons of the control unit on top of the tool
- Long lasting lithium ion cell batteries (full battery charge for several hundred vials, life time of battery > 1500 charges)
- CE certificate of conformity along with one year warranty
- One tool each necessary for crimping and for decapping
- For more convenient handling a stand is optionally available

Electronic high power crimping tool



Available for 11 mm and 20 mm crimp caps (also suitable for magnetic / bi-metal crimp caps). Due to a more powerful motor also suitable for magnetic and bi-metal crimp caps

- Fixed power supply
- Exchangeable crimping / decapping heads
- Digital LED display of crimp settings; different jaw settings can be stored in separate programs
- CE certificate of conformity along with one year warranty
- For more convenient handling a stand is optionally available

Ordering information

Description	Pack of	REF
Electronic crimpers (battery-powered)		
Electronic crimper for 11 mm aluminium crimp caps	1	735511
Electronic crimper for 20 mm aluminium crimp caps (not suitable for magnetic / bi-metal crimp caps)	1	735520
Electronic decappers (battery-powered)		
Electronic decapper for 11 mm aluminium crimp caps	1	735611
Electronic decapper for 20 mm aluminium crimp caps (not suitable for magnetic / bi-metal crimp caps)	1	735620
Accessories for battery-powered electronic crimping / decapping tools		
Replacement battery 6.6 Volt, 8.6 Wh	1	735500
Stand for electronic crimping tools	1	735501
Electronic high power crimping tool		
Electronic high power crimping tool with power supply (please order exchangeable crimping / decapping heads separately)	1	735700
Accessories for 735700		
Crimping head for 11 mm crimp caps (for electronic high power crimping tool 735700)	1	735711
Crimping head for 20 mm crimp caps (for electronic high power crimping tool 735700)	1	735720
Decapping head for 11 mm crimp caps (for electronic high power crimping tool 735700)	1	735811
Decapping head for 20 mm crimp caps (for electronic high power crimping tool 735700)	1	735820
Stand for electronic crimping tools	1	735501

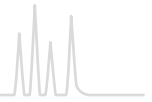

Autosampler compatibility charts

The autosampler compatibility charts generally show the most typical vials and closures for use on the instruments of a given manufacturer. In addition to the products listed in those charts, our catalog may contain other technically and functionally suitable products for use on a given autosampler which are not marketed actively as accessories by the respective manufacturer. We look forward to recommend any suitable product.

Compatibility charts have been compiled for the following instrument manufacturers: Agilent®, CTC, Dionex®, Knauer, PerkinElmer®, Shimadzu®, Thermo Scientific®, Varian® (Agilent®), VWR® (Merck®/Hitachi®), Waters®. Where applicable, each chart is divided into fields of use (GC, HPLC, Headspace).

We generally recommend that you ask for cost-free samples for testing purposes, as even technically comparable products may differ in their optical appearance.

We kindly ask for your understanding that we do not take over any guarantee for the correctness and completeness of the data indicated here.

Agilent®				
Application / Type of vial	Most popular MN products for use on Agilent® instruments			Page
	Vials:	Inserts:	Closures:	
GC				
N 8 crimp (micro sampling)	70282, 70286		70289, 702878	101
N 9 screw (standard sample)	702282, 702293, 702283, 702078, 702284, 702079, 702006, 702088, 702007, 702008, 702135, 702335, 702009, 702172, 702010, 702500	702716, 702813, 702077, 702818, 702818.1, 702825	702732, 702080, 702082, 702081, 702287.1, 702037, 702038, 702035, 702084, 702085, 702026	104
N 11 crimp (standard sample)	70201HP, 70201HP.2, 702885, 702075, 702892, 702076, 702888, 702015, 702016, 702891, 702014, 702134, 702334	702716, 702813, 702077, 702818, 702818.1, 702825	702155 (for GC PAL) 70256, 702730, 702001, 70231.3, 70231.1, 70231.2, 70288, 702995, 702146	109
HPLC				
N 9 screw (standard sample)	as indicated under GC, additionally closures with slit septum: 702288.1, 702083, 702040, 702027, however, not closure 702155			104
N 11 crimp (standard sample)	as indicated under GC, however, not closures 702146 and 702879			109
N 11 snap ring (standard sample)	702714, 702713, 702712, 702709, 702134, 702334, 702809, 702173, 702174	702716, 702813, 702077, 702818, 702818.1, 702825	702063, 702063.2080, 702710.1, 702710.2080, 702731, 702064, 702718	114
Headspace				
N 18 screw (Combi PAL + G 1888A)	702866, 702826, 702826.2			125
N 20 crimp	702918, 702261		70234, 70234.10, 702071, 702094, 702835, 70237	126
	for Combi PAL: 702924, 702263, 702263.2		702929 (for Combi PAL)	



Autosampler compatibility



CTC				
Application / Type of vial	Most popular MN products for use on CTC instruments			Page
	Vials:	Inserts:	Closures:	
GC				
N 8 crimp (micro sampling)	70282, 70286		70289, 702878	101
N 9 screw (standard sample)	702282, 702293, 702283, 702284, 702078, 702079, 702006, 702007, 702008, 702135, 702335	702716, 702813, 702077, 702818, 702818.1, 702825	702287, 702287.1, 702036, 702037, 702038, 702107, 702026, 702286, 702035, 702158, 702084, 702085, 702159 702155 (for GC PAL)	104
N 11 crimp (standard sample)	70201HP, 70201HP.2, 702885, 702892, 702075, 702076, 702888, 702891, 702014, 702134, 702334	702716, 702813, 702077, 702818, 702818.1, 702825	70288, 702995 702879 (for GC PAL)	109
HPLC				
N 9 screw (standard sample)	as indicated under GC, additionally closures with slit septum: 702288, 702288.1, 702027, 702039, 702040, 702083, 702109, however, not closure 702155			104
N 11 crimp (standard sample)	as indicated under GC, additionally closure 702823 with slit septum, however, not closure 702879			109
N 11 snap ring (standard sample)	702714, 702713, 702712, 702709, 702134, 702334, 702809, 702173, 702174	702716, 702813, 702077, 702818, 702818.1, 702825	702710.1, 702717.2, 702718.1, 702710, 702064, 702718	114
Headspace				
N 18 screw (Combi PAL)	702866, 702826, 702826.2			125
N 20 crimp	702924, 702263, 702263.2			126
			closure for washer bottle 702924: 70267 + 702144	

Dionex® (Thermo Scientific®)				
Application / Type of vial	Most popular MN products for use on Dionex® instruments			Page
	Vials:	Inserts:	Closures:	
HPLC				
N 8 crimp (micro sampling)	70282, 70286		702025, 70289	101
N 8 screw (standard sample)	70213, 70213.2, 702004, 702893, 702860	702968, 702968.1, 702824, 702005	70245, 702437	102
N 9 screw (standard sample)	702282, 702293, 702283, 702284, 702078, 702079, 702007, 702008, 702135, 702335, 702006, 702009, 702172, 702010, 702500	702813, 702077, 702818, 702818.1, 702825	702287.1, 702287, 702036, 702037, 702038, 702107, 702288.1, 702288, 702039, 702040, 702083, 702109, 702026, 702027	104
N 11 crimp (standard sample)	70201HP, 70201HP.2, 702885, 702892, 702075, 702076, 702888, 702891, 702014, 702134, 702334	702813, 702077, 702818, 702818.1, 702825	70288, 702823, 70256	109
N 11 snap ring (standard sample)	702714, 702713, 702712, 702709, 702134, 702334, 702809, 702173, 702174	702813, 702077, 702818, 702818.1, 702825	702710.1, 702710, 702710.2080, 702717.2, 702064, 702717.2080	114
N 13 screw (large sample volumes)	702962, 702973	702972 + spring 702974	702926	119



Autosampler compatibility

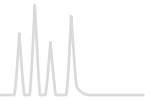

Knauer				
Application / Type of vial	Most popular MN products for use on Knauer instruments			Page
	Vials:	Inserts:	Closures:	
HPLC (Knauer S3950, Knauer UHPLC Version AS-1, Knauer Optimas)				
N 8 screw (standard sample)	70213, 70213.2, 702004, 702893	702968, 702968.1, 702824, 702005	702067, 70245	102
N 9 screw (standard sample)	702282, 702293, 702283, 702284, 702078, 702079, 702006, 702007, 702008, 702135, 702335, 702088, 702009, 702172, 702010, 702500	702813, 702077, 702716, 702818, 702818.1, 702825	702732, 702030, 702080, 702081, 702082, 702147, 702287.1, 702287, 702036, 702037, 702038, 702107, 702028, 702026	104
N 18 screw (large sample volumes)	702866		702072, 702055, 702827	125
N 20 crimp (large sample volumes)	702918		702094, 702129	126

PerkinElmer®				
Application / Type of vial	Most popular MN products for use on PerkinElmer® instruments			Page
	Vials:	Inserts:	Closures:	
GC				
N 8 crimp (micro sampling)	70251		70252.1, 702025	101
N 11 crimp (standard sample)	70201CG*, 70214CG*, 70201HP**, 70201HP.2**, 702885**, 702892**, 702075**, 702076**, 702891, 702014, 702134, 702334	702824*, 702005*, 702818**, 702818.1**, 702825**	702730, 70256, 70231.1, 70231.2, 70231.3, 70288, 702995	109
* small opening; ** wide opening				
HPLC				
N 8 crimp (micro sampling)	70286		70252.1, 702025	101
N 8 screw (standard sample)	70213, 70213.2, 702004, 702892	702824, 702005	702067 = 70249 + 702070, 70245	102
N 9 screw (standard sample)	702282, 702293, 702283, 702284, 702078, 702079, 702009, 702172, 702010, 702500, 702007, 702008, 702135, 702335	702818, 702818.1, 702825	702288.1, 702027, 702287.1, 702026, 702732, 702028	104
N 10 screw (standard sample)	702012, 702013	702818, 702818.1, 702825	702047, 702044, 702045, 702046	108
N 11 crimp (standard sample)	as indicated under GC			109
N 11 snap ring (standard sample)	702714, 702713, 702712, 702709, 702134, 702334	702818, 702818.1, 702825	702064, 702710, 702718	114
Headspace				
N 18 screw (CTC Combi PAL + TurboMatrix™ HS 16 + 40)	702866, 702826, 702826.2		702055, 702827, 702072	125
N 20 crimp (CTC Combi PAL)	702924, 702263, 702263.2		702929, 702834, 702774, 702928.9, 702928	126
N 20 crimp (TurboMatrix™ HS 16, 40 + 110)	702917**, 70254, 702540, 702541		702836, 702773, 702829, 70234.8, 702775, 70234.9, 702835, 702927, 702094, 702093, 702145, 70234, 70234.10, 702931 + 702804, 70237	126
** not suited for TurboMatrix™ 110				



Autosampler compatibility



Shimadzu®				
Application / Type of vial	Most popular MN products for use on Shimadzu® instruments			Page
	Vials:	Inserts:	Closures:	
GC				
N 8 crimp (micro sampling)	70282, 70286		70289, 702878	101
N 9 screw (standard sample)	702282, 702293, 702283, 702284, 702078, 702079, 702006, 702007, 702008, 702135, 702335	702716, 702813, 702077, 702825, 702818, 702818.1	702081, 702036, 702037, 702038, 702107, 702287.1, 702026 702155 (for AOC 5000)	104
N 10 screw (standard sample)	702011, 702012, 702013	as indicated under N 9 screw	702045, 702046, 702048	108
N 11 crimp (standard sample)	70201HP, 70201HP.2, 702885, 702892, 702075, 702076, 702888, 702891, 702014, 702134, 702334, 702141	702716, 702813, 702077, 702825, 702818, 702818.1	70288, 702995 702879 (for AOC 5000)	109
N 13 screw (large sample volumes)	702962, 702973	702972 + spring 702974	702926, 702963 + 702292	119
HPLC				
N 8 crimp (micro sampling)	70282, 70286		70289, 702878	101
N 9 screw (standard sample)	702282, 702293, 702283, 702284, 702078, 702079, 702006, 702007, 702008, 702135, 702335	702716, 702813, 702077, 702825, 702818, 702818.1	702287.1, 702036, 702037, 702038, 702107, 702026, 702039, 702040, 702083, 702288.1, 702109, 702027	104
N 10 screw (standard sample)	702011, 702012, 702013	as indicated under N 9 screw	702045, 702046, 702047	108
N 11 crimp (standard sample)	as indicated under N 11 crimp GC	as indicated under N 11 crimp	70288, 702823	109
N 11 snap ring (standard sample)	702714, 702713, 702712, 702709, 702134, 702334	as indicated under N 9 screw	702710.1, 702710, 702717.2, 702064	114
N 8, N 12 shell vials (standard sample)			vials + stoppers: 70202.1 + 702807, 702017 + 702807, 702018 + 702054	124
Headspace				
N 18 screw (AOC 5000)	702866, 702826, 702826.2		702055, 702827	125
N 20 crimp (AOC 5000)	702924, 702263, 702263.2		702929, 702928, 702834 for washer bottle 702924: 70267 + 702144	126



Autosampler compatibility

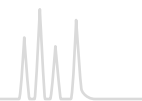

Thermo Scientific®				
Application / Type of vial	Most popular MN products for use on Thermo Scientific® instruments			Page
	Vials:	Inserts:	Closures:	
GC				
N 8 crimp (micro sampling)	70282, 70286, 70251		70289, 702025	101
N 8 screw (standard sample)	70213, 70213.2, 702004, 702893	702968, 702968.1, 702824, 702005	702067, 70245, 702069	102
N 9 screw (standard sample)	702282, 702293, 702283, 702284, 702078, 702079, 702006, 702007, 702008, 702135, 702335	702716, 702813, 702077, 702818, 702818.1, 702825	702732, 702081, 702084, 702287.1, 702037, 702026 702155 (for GC PAL)	104
N 11 crimp (standard sample)	70201HP, 70201HP.2, 702885, 702892, 702075, 702076, 702888, 702891, 702014, 702134, 702334	702716, 702813, 702077, 702818, 702818.1, 702825	70256, 702730, 70288 702879 (for GC PAL)	109
HPLC				
N 8 crimp (micro sampling)	70282, 70286		70289, 702025	101
N 8 screw (standard sample)	as indicated under GC			102
N 9 screw (standard sample)	as indicated under GC, but additionally closures 702040 and 702027, however, not closure 702155			104
N 11 crimp (standard sample)	as indicated under GC, however, not closure 702879			109
N 11 snap ring (standard sample)	702714, 702713, 702712, 702709, 702134, 702334, 702809, 702173, 702174	702716, 702813, 702077, 702818, 702818.1, 702825	702063.2080, 702063, 702710.2080, 702710.1, 702717.2080, 702710.2080	114
Headspace				
N 18 screw (Combi PAL)	702866, 702826, 702826.2		702055, 702827	125
N 20 crimp (Combi PAL)	702924, 702263, 702263.2		702929, 702834	126
N 20 crimp (HS850/HS200)	702924, 702263, 702263.2		702775, 70234.9, 702773, 702931 + 702804 = 70237, 702093	126

Varian® (now Agilent®)				
Application / Type of vial	Most popular MN products for use on Varian® instruments			Page
	Vials:	Inserts:	Closures:	
GC				
N 8 crimp (micro sampling)	70282, 70286		70289, 702878	101
N 8 screw (standard sample)	70213, 70213.2, 702004, 702893	702968.1, 702824, 702005	702067, 70245, 702069	102
N 9 screw (standard sample)	702282, 702293, 702283, 702284, 702078, 702006, 702079, 702008, 702007, 702135, 702335	702813, 702077, 702818, 702818.1, 702825	702732, 702287.1, 702037, 702084 702155 (for GC PAL)	104
N 11 crimp (standard sample)	70201HP, 70201HP.2, 702885, 702892, 702075, 702076, 702888, 702891, 702014, 702134, 702334	702813, 702077, 702818, 702818.1, 702825	70256, 702730, 70288, 702995 702879 (for GC PAL)	109
HPLC				
N 8 crimp (micro sampling)	as indicated under GC			101
N 8 screw (standard sample)	as indicated under GC, but additionally closure 702437			102
N 9 screw (standard sample)	as indicated under GC, but additionally PP vials 702009, 702172, 702010, 702500 as well as closures 702040 and 702288.1			104
N 11 crimp (standard sample)	as indicated under GC, but additionally closures 70231.4 and 70231.2			109
N 11 snap ring (standard sample)	702714, 702713, 702712, 702709, 702134, 702334, 702809, 702173, 702174	702813, 702077, 702818, 702818.1, 702825	702731, 702063, 702710, 702710.1, 702064, 702717.2, 702718, 702718.1	114
Headspace				
N 18 screw (Combi PAL)	702866, 702826, 702826.2		702827, 702072, 702055	125
N 20 crimp (Combi PAL)	702924, 702263, 702263.2		702929, 702834	126
N 20 crimp (CP-9020/9025, CP-9060, Genesis)	702924, 702918, 702261		70234, 70234.10, 702775, 702094, 702931 + 702804 = 70237	126



Autosampler compatibility



VWR® (Merck® / Hitachi®)

Application / Type of vial	Most popular MN products for use on VWR® instruments			Page
	Vials:	Inserts:	Closures:	
HPLC				
N 8 crimp (micro sampling)	70282, 70286		70289, 702878	101
N 8 screw (standard sample)	70213, 70213.2, 702004, 702893, 702860	702968, 702968.1, 702824, 702005	70245, 702437, 702067	102
N 9 screw (standard sample)	702282, 702293, 702283, 702078, 702284, 702079, 702007, 702008, 702135, 702335, 702006, 702009, 702172, 702010, 702500	702813, 702077, 702818, 702818.1, 702716, 702825	702287.1, 702287, 702036, 702037, 702038, 702107, 702288.1, 702288, 702039, 702040, 702083, 702109, 702026, 702027	104
N 11 crimp (standard sample)	70201HP, 70201HP.2, 702885, 702075, 702892, 702076, 702888, 702891, 702014, 702134, 702334	702813, 702077, 702818, 702818.1, 702716, 702825	70288, 702823	109
N 11 snap ring (standard sample)	702714, 702713, 702712, 702709, 702134, 702334, 702809, 702173, 702174	702813, 702077, 702818, 702818.1, 702716, 702825	702710.1, 702710, 702717.2, 702064, 702718.1, 702718, 702063, 702731	114
N 13 screw (large sample volumes)	702962, 702973	702972 + spring 702974	702926, 702963 + 70260	119

Waters®

Application / Type of vial	Most popular MN products for use on Waters® instruments			Page
	Vials:	Inserts:	Closures:	
HPLC				
N 9 screw (standard sample)	702282, 702293, 702283, 702284, 702078, 702079, 702007, 702008, 702135, 702335, 702006, 702009, 702172, 702010, 702500	702818, 702818.1	702026, 702027, 702287.1, 702287, 702036, 702037, 702038, 702288.1, 702288, 702039, 702040, 702083	104
N 10 screw (standard sample)	702011, 702012, 702013	702818, 702818.1	702045, 702046, 702047	108
N 11 crimp (standard sample)	70201HP, 70201HP.2, 702885, 702892, 702075, 702076	702818, 702818.1	70288, 702995	109
N 11 snap ring (standard sample)	702714, 702713, 702712, 702709, 702134, 702334, 702809, 702173, 702174	702818, 702818.1	702710.1, 702717.2	114
N 8 shell vials (standard sample)			vials + closures: 70202.1 + 702807, 702017 + 702807	124
N 13 screw (large sample volumes)	702962, 702973	702972 + spring 702974	702926, 702963 + 70260	119

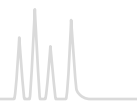

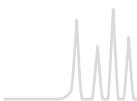

Contents

Basics.....	144
USP listing.....	148
NUCLEODUR® high purity silica for HPLC.....	150
NUCLEODUR® for UHPLC.....	151
NUCLEODUR® phase overview.....	152
NUCLEODUR® columns.....	158
NUCLEOSHELL® core-shell silica for HPLC.....	192
NUCLEOSHELL® phase overview.....	198
NUCLEOSHELL® columns.....	200
NUCLEOSIL® standard silica for HPLC.....	211
NUCLEOSIL® phase overview.....	212
NUCLEOSIL® columns.....	214
Analytical columns with LiChrospher®.....	225
Phase overview for special separations.....	226
HPLC columns for environmental analyses.....	227
HPLC columns for enantiomer separations.....	231
HPLC columns for biochemical separations.....	237
HPLC columns for sugar analyses.....	246
Columns for gel permeation chromatography.....	249
MN column systems.....	250
Accessories.....	254
Packings for preparative applications:	
NUCLEODUR® high purity silica for HPLC.....	256
POLYGOSIL® irregular silica for HPLC.....	257
POLYGOPREP irregular silica for HPLC.....	258
Adsorbents for column chromatography.....	260

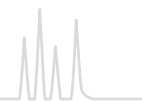

High performance liquid chromatography (HPLC) is part of liquid chromatographic separating processes of substance mixtures and their analysis. At the beginning the technique was also called high pressure liquid chromatography due to the high back pressure of the column. HPLC offers qualitative (identification of substances) and quantitative (concentration determination) analysis by comparison with standard substances. The term HPLC was introduced in the 1970s, for the delineation of the high-performance method to the in the 1930s developed column liquid chromatography (column chromatography). At the beginning of the 21st century the HPLC was complemented by the even more efficient UHPLC (ultra high performance liquid chromatography). Hereby even higher pressures (> 400 bar) result in shorter analysis time and enhanced efficiency enabling a higher sample throughput with smaller sample volumes.

Application

HPLC/UHPLC is used additionally to gas chromatography (GC) for separation and determination of complex substance mixtures composed of low-volatile, polar and ionic, high-molecular or thermal instable substances. Therefore a sufficient solubility of the sample in a solvent or a solvent mixture is required. HPLC/UHPLC is used for purity control of chemicals and industrial products, determination of active agents for drug development, production and testing, environmental analytics, quality and purity control of foods, analysis of ingredients in cosmetics as well as for the isolation of biopolymers.

Basic principle

In liquid column chromatography a mobile phase (eluent) flows through a particle filled tube (separation column, stationary phase). In classic column chromatography this tube is a glass column with an inner diameter of several centimeters and a length up to 450 mm or even bigger. The filling material typically consists of coarse-grained particles like silica gel 60. The eluent is transported through the separation column either by hydrostatic pressure or a low-pressure pump with 1.5-2 bar.

In contrast HPLC columns consist of stainless steel with an inner diameter of 2-4.6 mm and a length of 20-300 mm. The column packing, mostly modified porous silica, has generally a particle size of 3, 5, 7 or 10 μm and a pore size of 50, 100, 120 (for low-molecular analytes) or 300-4000 \AA (for high-molecular analytes). In UHPLC shorter columns in the range of 20-150 mm length with highly efficient particles of 1.8 μm size (sub-2 μm) are utilized. A guard column of a few millimeters length can be utilized and installed with a specific Column Protection System to increase the column lifetime. HPLC/UHPLC uses a high-pressure pump to transport the eluent from a storage vessel into the system with a column back pressure of up to 600/ 1200 bar.

Instrument

HPLC as well as UHPLC instruments have different building blocks. The storage vessel (eluent reservoir, 1) usually contains a deaerator unit (3) for the solvents. Followed by a gradient valve (4) with mixing chamber (5) in flow direction, which allows the usage of isocratic as well as gradient methods. A high-pressure pump (6) transports the sample into the system. The sample is injected via an injection valve (7). Usually this is operated automatically with a syringe by an autosampler. With the eluent flow the sample is transported to the guard and the separating column (8). For better reproducibility of the separation tempering with a column oven (2) should be performed. The separated substances are determined with a detector (9). In the resulting chromatogram each detector signal of a substance (peak), is related to the retention time of the column. With the data evaluation (10) these peaks can be identified and their concentration can be determined.

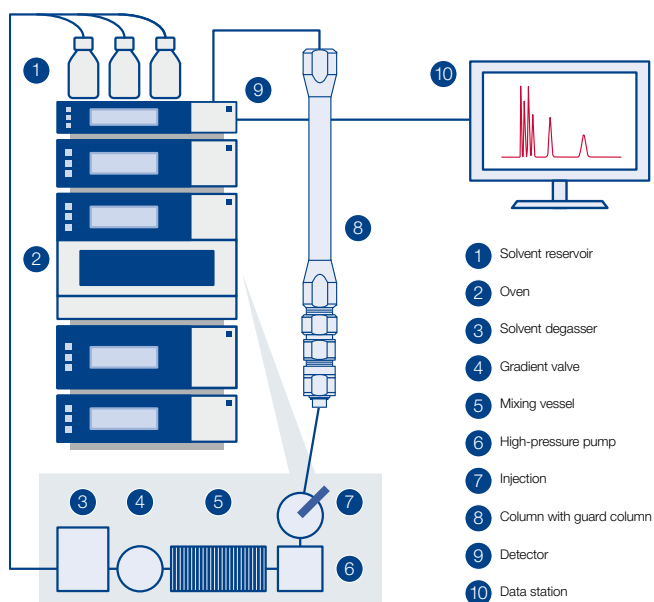



Separation mechanism

While flowing through the column each component of the solved mixture interacts differently with the stationary phase. According to the characteristics of the substance (hydrophobic, polar, ionic, aromatic, sterically hindered etc.) the strength of the interactions vary and thus the compounds are retained by the stationary phase in different ways. Essentially a distinction is drawn between normal phase (NP), reversed phase (RP) and ion exchange chromatography. Depending on the structure of the stationary phase diverse interactions e.g., van der Waals forces or π - π -stacking can occur and different polar mobile phases are required. For polar stationary normal phases (e.g., SiOH, CN, OH, NH₂) non-polar eluents like *n*-heptane, hexane, dichloromethane or 2-propanol are applicable. While for reversed phases (e.g., C₁₈, C₈, C₄, C₂, C₆H₅) typically polar RP eluents (e.g., acetonitrile or methanol with ultrapure water or buffer) and for ion exchange (e.g., SA, SB) aqueous buffers (e.g., phosphate, acetate, citric buffer) come to use.

Selectivity

The characteristic separation behavior of phases under certain conditions is also called selectivity. This is dependent on different parameters like structure and modifications of the base silica gel, nature of the chemical binding or the type of endcapping. In recent decades several methods have been developed to compare and distinguish the selectivity of various silica gels and their modifications. In this connection defined substances or substance classes are analyzed and the chromatographic parameters are graphically presented. A frequently applied model in specialist literature is e.g., the TANAKA plot, which allows a quick comparison of different HPLC phases. [4]

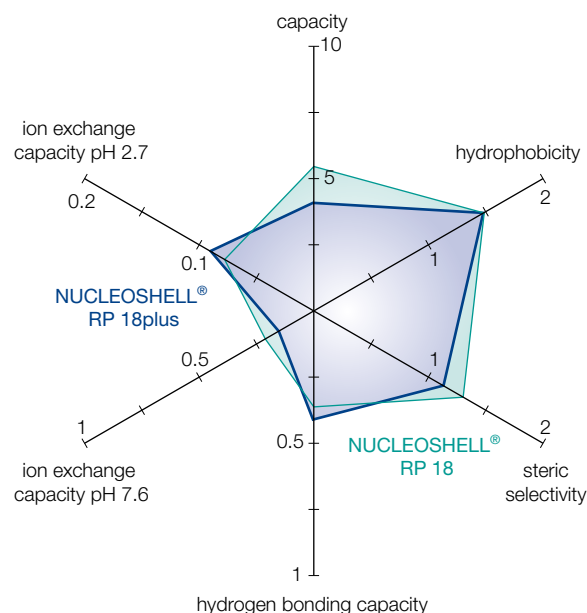

Parameter of the Tanaka diagram:

Capacity = k' (pentylbenzene)

Hydrophobicity = α (pentylbenzene, butylbenzene)

Steric selectivity = α (triphenyl, *o*-terphenyl)

Hydrogen bonding capacity (capacity of silanol) = α (caffeine, phenol)

Ion exchange capacity at pH 2.7 = α (benzylamine, phenol)

Ion exchange capacity at pH 7.6 = α (benzylamine, phenol)

The comparison of NUCLEOSHELL® RP 18 and NUCLEOSHELL® RP 18plus for example shows a lower ion exchange capacity at pH 7.6 for the monomeric NUCLEOSHELL® RP 18plus. The radar chart also reflects a more pronounced steric selectivity of NUCLEOSHELL® RP 18 due to a higher density of modifications with C₁₈ chains.

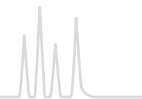

Characteristic parameters

The success of a chromatographic separation depends apart from the stationary and mobile phase also on other characteristics like the quality of the separating column or the linear flow rate. The following schematic chromatogram illustrates the most important parameters which characterize a separation.

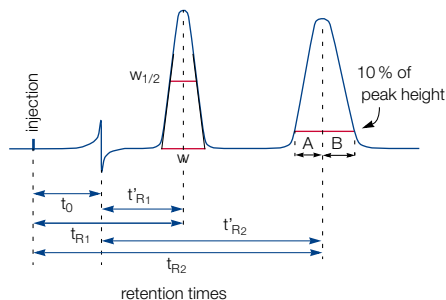

Schematic chromatogram

Peak width:	
$w_{1/2}$	peak width at half height
w	peak width of the peak (intersection point of the inflectional tangents with the zero line)
Peak symmetry:	
A	peak front to peak maximum at 10% of peak height
B	peak maximum to peak end at 10% of peak height
Retention time::	
t_0	dead time of a column = retention time of a non-retarded substance
t_{R1}, t_{R2}	retention times of components 1 and 2
t'_{R1}, t'_{R2}	net retention times of components 1 and 2

In a chromatographic system the substances differ from each other in their retention time in or on the stationary phase. The time, which is needed by a sample component to migrate from column inlet (sample injection) to the column end (detector) is the retention time t_{R1} or t_{R2} . The dead time t_0 is the time required by an inert compound to migrate from column inlet to column end without any retardation by the stationary phase. Consequently, the dead time is identical with the retention time of the sample component remaining in the stationary phase. The difference of total retention time and dead time yields the net retention time t'_{R1} or t'_{R2} , which is the time a sample component remains in the stationary phase.

$$t'_{R1} = t_{R1} - t_0 \text{ bzw. } t'_{R2} = t_{R2} - t_0$$

To compare chromatograms that are recorded with columns of different lengths and internal diameters, as well as different flow rates, the retention time is converted into a dimensionless capacity factor k' .

$$k'_1 = \frac{t_{R1} - t_0}{t_0} \text{ bzw. } k'_2 = \frac{t_{R2} - t_0}{t_0}$$

The relative retention α , also known as the separation factor, describes the ability of a chromatographic system (stationary and mobile phase) to distinguish between two compounds. This

is calculated from the rate of the capacity factors of the substances, where the figure in the denominator is the reference compound.

$$\alpha = \frac{k'_2}{k'_1}$$

The resolution R is a measure for the efficiency of the column to separate two substances. Besides the retention time t_R the peak width at half height $w_{1/2}$ is also included.

$$R = 1.18 \cdot \frac{t_{R2} - t_{R1}}{(w_{1/2})_2 + (w_{1/2})_1}$$

For practical reasons the peak symmetry is calculated at 10% of peak height. Ideally symmetry should be 1, i.e. $A = B$. Values > 1 indicate peak tailing, while values < 1 indicate peak fronting.

$$\text{Peak symmetry} = \frac{B}{A}$$

Instead of the mobile phase volumetric flow rate [mL/min], which is controlled at the HPLC instrument, it is advantageous to use the linear velocity u [cm/sec]. The linear velocity is independent of the column cross section and proportional to the pressure drop in the column. The linear velocity can be calculated by means of the dead time, where L is the column length in cm and t_0 the dead time in sec.

$$u = \frac{L}{t_0}$$

The quality of a column packing is determined through the number of theoretical plates N . High N values indicate a high capability to separate complex sample mixtures.

$$N = 5.54 \cdot \left(\frac{t_{R1}}{w_{1/2}} \right)^2$$

The value of the height equivalent to a theoretical plate HEPT is a criterion for the quality of a column. HEPT, is the length, in which the chromatographic equilibrium between mobile and stationary phase has been adjusted once. Its value depends on the particle size, the flow velocity, the mobile phase viscosity and especially on the packing quality. Small HEPT values, meaning a large number of theoretical plates N , facilitate the column to separate complex sample mixtures.

$$H = \frac{L}{N}$$

The Van Deemter equation shows the dependence of the HEPT on the velocity u .

$$H = A + \frac{B}{u} + C \cdot u$$

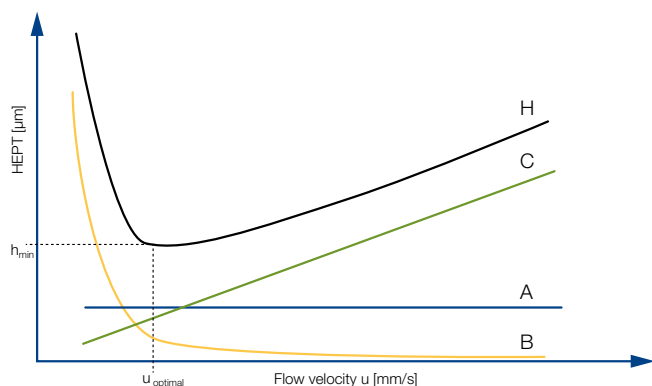
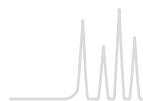

A term = eddy-diffusion, B term = longitudinal diffusion coefficient, C term = mass transfer coefficient, H = HEPT = height equivalent to a theoretical plate

The A term, also called eddy-diffusion, is a function of the particle size, the B term a function of the diffusion coefficient of the substance in the mobile phase and the C term the retardation

of a substance by the interface between stationary and mobile phase. In the point of intersection of h_{\min} and u_{opt} the optimal separation efficiency for a column with high peak symmetry for the separated substances is obtained.

Column quality

Each HPLC/UHPLC column of MACHEREY-NAGEL is individually tested according to the most important characteristic parameters in quality control and the results are documented in a certificate of analysis.

Detailed information of the particular properties of the high-purity silica phases NUCLEODUR®, of the established standard silica NUCLEOSIL® and the modern Core-Shell material NUCLEOSHELL® as well as phases for special separations and the equivalent HPLC- and UHPLC-columns can be found on the following pages.



Strict quality specifications for outstanding reliability

- Highest production standard
our facilities are EN ISO 9001:2008 certified
- Perfect reproducibility from batch to batch and within each lot
- Each column is individually tested and supplied with test chromatogram and test conditions.

Test mixture* for reversed phase columns
in acetonitrile, pack of 1 mL
REF 722394



Furthermore custom-packed columns with different column types, dimensions and particle sizes are available on request.

* This product (REF 722394) contains harmful substances which must be specially labeled as hazardous. For detailed information please see SDS.

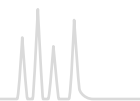

USP specification of MN HPLC phases		MN HPLC Phases	Page
Code	Specification		
USP L1	octadecyl silane chemically bonded to porous silica particles 1.5 to 10 µm diameter, or monolithic silica gel	NUCLEODUR® C ₁₈ ec	181
		NUCLEODUR® C ₁₈ Gravity	158
		NUCLEODUR® C ₁₈ Gravity-SB	162
		NUCLEODUR® C ₁₈ HTec	178
		NUCLEODUR® C ₁₈ Isis	164
		NUCLEODUR® C ₁₈ PAH	227
		NUCLEODUR® C ₁₈ Pyramid	166
		NUCLEODUR® PolarTec	168
		NUCLEODUR® Sphinx RP	176
		NUCLEOSHELL® RP 18	200
		NUCLEOSHELL® RP 18plus	202
		NUCLEOSIL® C ₁₈	214
		NUCLEOSIL® C ₁₈ AB	214
		NUCLEOSIL® C ₁₈ HD	214
NUCLEOSIL® C ₁₈ MPN	243		
USP L3	porous silica particles, 1.5 to 10 µm diameter, or monolithic silica gel	NUCLEODUR® SiOH	190
		NUCLEOSIL® SiOH	224
USP L7	octyl silane chemically bonded to totally porous silica particles, 1.8 to 10 µm diameter	NUCLEODUR® C ₈ ec	181
		NUCLEODUR® C ₈ Gravity	158
		NUCLEOSIL® C ₈	217
USP L8	an essentially monomolecular layer of aminopropyl silane chemically bonded to totally porous silica gel support, 1.5 to 10 µm diameter	NUCLEOSIL® C ₈ HD	217
		NUCLEODUR® NH ₂ /NH ₂ -RP	188
		NUCLEOSIL® Carbohydrate	246
USP L9	irregular or spherical, totally porous silica gel having a chemically bonded, strongly acidic cation-exchange coating, 3 to 10 µm diameter	NUCLEOSIL® NH ₂ /NH ₂ -RP	221
		NUCLEOSIL® SA	223
USP L10	nitrile groups chemically bonded to porous silica particles, 1.5 to 10 µm diameter	NUCLEODUR® CN / CN-RP	186
		NUCLEOSIL® CN / CN-RP	222



USP specification of MN HPLC phases

Code	Specification	MN HPLC Phases	Page
USP L11	phenyl groups chemically bonded to porous silica particles, 1.5 to 10 µm diameter	NUCLEODUR® Phenyl-Hexyl	170
		NUCLEODUR® π ²	172
		NUCLEOSHELL® Phenyl-Hexyl	204
		NUCLEODUR® Sphinx RP	176
		NUCLEOSIL® C ₆ H ₅	220
USP L14	silica gel having a chemically bonded, strongly basic quaternary ammonium anion-exchange coating, 5 to 10 µm diameter	NUCLEOSIL® SB	223
USP L16	dimethylsilane chemically bonded to porous silica particles, 5 to 10 µm diameter	NUCLEOSIL® C ₂	219
USP L17	strong cation-exchange resin consisting of sulfonated cross-linked PS/DVB copolymer in the H form, 6 to 12 µm diameter	NUCLEOGEL® ION 300 OA	248
		NUCLEOGEL® SUGAR 810 H	247
USP L19	strong cation-exchange resin consisting of sulfonated cross-linked PS/DVB copolymer in the Ca form, 5 to 15 µm particle size	NUCLEOGEL® SUGAR 810 Ca	247
		NUCLEOGEL® SUGAR Ca	248
USP L20	dihydroxypropane groups chemically bonded to porous silica particles, 5 to 10 µm diameter	NUCLEOSIL® OH (Diol)	220
USP L21	a rigid, spherical styrene-divinylbenzene copolymer, 5 to 10 µm diameter	NUCLEOGEL® RP	245
USP L22	a cation-exchange resin made of porous polystyrene gel with sulfonic acid groups, about 10 µm in size	NUCLEOGEL® SCX	240
USP L23	an anion-exchange resin made of porous polymethacrylate or polyacrylate gel with quaternary ammonium groups, about 10 µm in size	NUCLEOGEL® SAX	240
USP L26	butyl silane chemically bonded to totally porous silica particles, 5 to 10 µm diameter	NUCLEODUR® C ₄ ec	241
		NUCLEOSIL® C ₄	219
		NUCLEOSIL® C ₄ MPN	243
USP L32	a chiral ligand-exchange resin packing · L-proline copper complex covalently bonded to irregular shaped silica particles, 5 to 10 µm diameter	NUCLEOSIL® CHIRAL-1	235
USP L34	strong cation-exchange resin consisting of sulfonated cross-linked PS-DVB copolymer in the Pb form, 5 to 7 µm particle size	NUCLEOGEL® SUGAR Pb	248
USP L36	a 3,5-dinitrobenzoyl derivative of L-phenylglycine covalently bonded to 5 µm aminopropyl silica	NUCLEOSIL® CHIRAL-3	236
USP L40	cellulose tris-(3,5-dimethylphenylcarbamate) coated porous silica particles, 5 to 20 µm diameter	NUCLEOCEL DELTA	233
USP L43	pentafluorophenyl groups chemically bonded to silica particles by a propyl spacer, 1.5 to 10 µm diameter	NUCLEODUR® PFP	174
		NUCLEOSHELL® PFP	206
USP L45	beta-cyclodextrin bonded to porous silica particles, R,S-hydroxypropyl ether derivative, 3 to 10 µm diameter	NUCLEODEX β-OH, β-PM	231
USP L58	strong cation-exchange resin consisting of sulfonated cross-linked PS/DVB copolymer in the Na form, 6 to 30 µm diameter	NUCLEOGEL® SUGAR Na	248
USP L60	spherical porous silica gel, particle size of 10 µm diameter or smaller, the surface of which has been covalently modified with alkyl amide groups and endcapped	NUCLEODUR® PolarTec	168
		NUCLEOSIL® C ₁₈ Nautilus	214
USP L75	A chiral-recognition protein, bovine serum albumin (BSA), chemically bonded to silica particles, about 7 µm in diameter, with a pore size of 300 Angstrom	RESOLVOSIL BSA-7	234

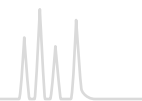

NUCLEODUR® is a fully synthetic type B silica (silica of 3rd generation) offering highly advanced physical properties like totally spherical particle shape, outstanding surface micro-structure, high pressure stability and low metal content.

NUCLEODUR® as a state-of-the-art silica is the ideal base material for modern HPLC phases. It is the result of MACHEREY-NAGEL's pioneering research in chromatography for more than 40 years.

In RP liquid chromatography the efficiency of the packing is strongly affected by the quality of the base silica itself. Shortcomings in the surface geometry of the particles or metal contaminants are the main reasons for inadequate coverage with the covalently bonded alkylsilanes in the subsequent derivatization steps. It is well known, that poor surface coverage and, in consequence, high activity of residual free silanols often results in peak tailing or adsorption, particularly with basic compounds.

Particle shape and surface symmetry

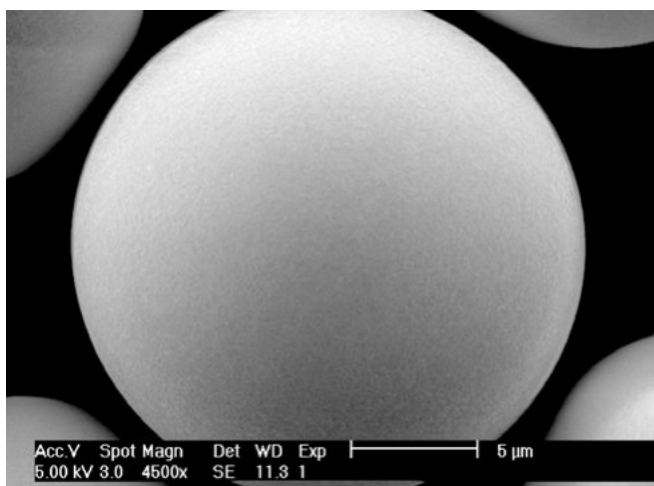

NUCLEODUR® silicas are synthesized in a unique and carefully controlled manufacturing process which provides silica particles, which are totally spherical. The picture shows the outstanding smoothness of the NUCLEODUR® surface.

Purity

As already mentioned above, a highly pure silica is required for achieving symmetric peak shapes and maximum resolution. Inclusions of, e.g., iron or alkaline earth metal ions on the silica surface are largely responsible for the unwanted interactions with ionizable analytes, e.g., amines or phenolic compounds.

NUCLEODUR® is virtually free of metal impurities and low acidic surface silanols. Elemental analysis data of NUCLEODUR® 5 µm measured by AAS are listed below.

Elementary analysis (metal ions) of NUCLEODUR® 100-5

Aluminum	< 5	ppm
Iron	< 5	ppm
Sodium	< 5	ppm
Calcium	< 10	ppm
Titanium	< 1	ppm
Zirconium	< 1	ppm
Arsenic	< 0.5	ppm
Mercury	< 0.05	ppm

Pressure stability

The totally spherical and 100 % synthetic silica gel exhibits an outstanding mechanical stability, even at high pressures and elevated eluent flow rates. In addition, after several cycles of repeated packing, no significant drop in pressure can be observed. The latter is of prime importance for preparative and process-scale applications.

NUCLEODUR® silica is available with two pore sizes – 110 Å pore size as standard material and as 300 Å widepore material for the separation of biomolecules, like peptides and proteins.

Physical data of NUCLEODUR®

	Standard	Widepore
Pore size	110	300 Å
Surface area (BET)	340 m ² /g	100 m ² /g
Pore volume	0.9 mL/g	0.9 mL/g
Density	0.47 g/mL	0.47 g/mL

NUCLEODUR® modifications

Several different surface modifications based on NUCLEODUR® silica have been developed over the last years providing a full range of specified HPLC phases and an ideal tool for every separation.

For a summary of important properties of our NUCLEODUR® phases please see page 152.



1.8 µm particles for increased separation efficiency

Key feature

- Decrease of analysis time (ultra fast HPLC)
- Shorter columns with high separation efficiency and significant improvement of resolution and detection sensitivity
- Suitable for LC/MS due to low bleeding characteristics

Fractionation

- NUCLEODUR® 1.8 µm particles are fractionated to limit the increase in back pressure.

Availability

- The following NUCLEODUR® phases are available in 1.8 µm:
C₁₈ Gravity, C₈ Gravity, C₁₈ Gravity-SB, C₁₈ Isis, C₁₈ Pyramid, PolarTec, Phenyl-Hexyl, PFP, Sphinx RP, C₁₈ HTec and HILIC

Advantages of 1.8 µm particle size

Miniaturization started in the early stage of HPLC with the reduction of particle size from 10 µm via 7 µm to standard 5 µm – still the most used particle diameter in analytical HPLC – to 3 µm spherical particles. With the introduction of 1.8 µm NUCLEODUR® particles researchers have turned over a new leaf in HPLC column technology, featuring extraordinary improvements in terms of plate numbers, column efficiency and resolution compared with 3 µm particles.

Increased separation efficiency by higher number of theoretical plates (N):

- 50 x 4.6 mm NUCLEODUR® C₁₈ Gravity
- 3 µm: N ≥ 100 000 plates/m (h-value ≤ 10)
- 1.8 µm: N ≥ 166 667 plates/m (h-value ≤ 6)

Increase of the plate number by ~ 67 % offers the possibility of using shorter columns with equal plate number resulting in a decrease of analysis time.

Significant improvement in resolution

$$R_s = \frac{\sqrt{N}}{4} \left(\frac{\alpha - 1}{\alpha} \right) \left(\frac{k'_i}{k'_i + 1} \right)$$

R_s = resolution, α = selectivity (separation factor), k'_i = retention
N = plate number with N ∝ 1/d_p, d_p = particle diameter

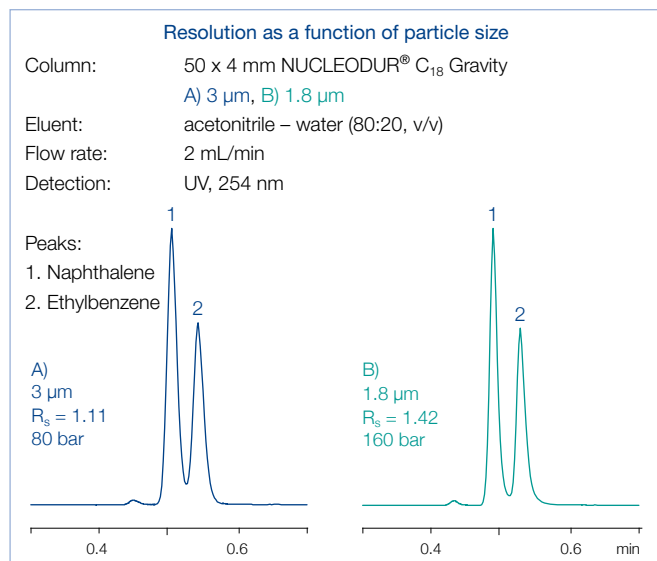

Use of 1.8 µm instead of 3 µm particles leads to an increase of resolution by a factor of 1.29 (29 %) since the resolution is inversely proportional to the square root of the particle size.

Column back pressure

Due to the smaller particles the back pressure will increase according to

$$\Delta_p = \frac{\Phi \cdot L_C \cdot \eta \cdot u}{d_p^2}$$

Δ_p = pressure drop, Φ = flow resistance (nondimensional), L_C = column length, η = viscosity, u = linear velocity, d_p = particle diameter

The high sphericity of the NUCLEODUR® particles and the very narrow particle size distribution allow to keep the back pressure on a moderate level.

Comparison of back pressures

Eluent 100 % methanol, flow rate 1.5 mL/min
 temperature 22 °C, column dimensions 50 x 4.6 mm

	NUCLEODUR® C ₁₈ Gravity	Competitor
3 µm	70 bar	–
1.8 µm	130 bar	170 bar

Higher flow rates and shorter run times

The optimal flow rate for 1.8 µm particles is higher than for 3 and 5 µm particles (see figure – the flow rate should be at the van Deemter minimum).

Van Deemter curves

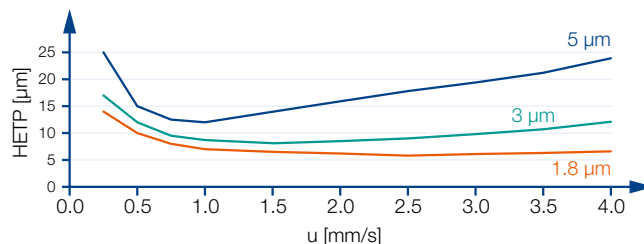

Technical requirements







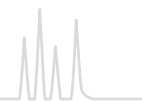



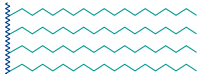

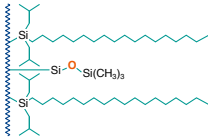

To gain best results with 1.8 µm particles certain technical demands must be met including pumps for flow rates of 2–3 mL with pressures of 250–1000 bar, minimized dead volume, and fast data recording.

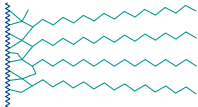

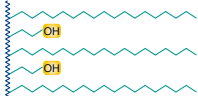
NUCLEODUR[®] phase overview

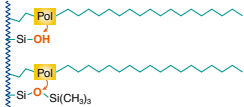

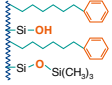
Overview of NUCLEODUR[®] HPLC phases

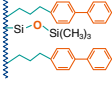
Phase	Specification	Page	Characteristic*	Stability	Structure
 C ₁₈ Gravity	octadecyl, high density coating, multi-endcapping 18 % C · USP L1	158	A ●●●●● B ● C ●●●	pH 1–11, suitable for LC/MS	NUCLEODUR [®] (Si-O) ₂ n 
 C ₁₈ Gravity-SB	octadecyl (monomeric), extensive endcapping 13 % C · USP L1	162	A ●●●●● B ●●●● C -	pH 1–9, suitable for LC/MS	NUCLEODUR [®] (Si-O) ₂ n 
 C ₈ Gravity	octyl, high density coating, multi-endcapping 11 % C · USP L7	158	A ●●●● B ●● C ●●	pH 1–11, suitable for LC/MS	NUCLEODUR [®] (Si-O) ₂ n 
 C ₁₈ Isis	octadecyl phase with specially crosslinked surface modification 20 % C · USP L1	164	A ●●●●●● B ●●●● C ●●●●●●	pH 1–10, suitable for LC/MS	NUCLEODUR [®] (Si-O) ₂ n 
 C ₁₈ Pyramid	octadecyl with polar endcapping 14 % C · USP L1	166	A ●●●●● B ●●●●● C ●●●	stable in 100 % aqueous eluent, pH 1–9, suitable for LC/MS	NUCLEODUR [®] (Si-O) ₂ n 
 PolarTec	octadecyl with embedded polar group 17 % C · USP L1 and L60	168	A ●●●●● B ●●●●● C ●●●●●	stable in 100 % aqueous eluent, pH 1–9, suitable for LC/MS	NUCLEODUR [®] (Si-O) ₂ n 
 Phenyl-Hexyl	phenylhexyl, multi-endcapping 10 % C · USP L11	170	A ●●● B ●●●●● C ●●	pH 1–10, suitable for LC/MS	NUCLEODUR [®] (Si-O) ₂ n 
 π ²	biphenylpropyl, multi-endcapping 17 % C · USP L11	172	A ●●● B ●●●●● C ●●●●	pH 1.5–10	NUCLEODUR [®] (Si-O) ₂ n 

* A = ● hydrophobic selectivity, B = ● polar / ionic selectivity, C = ● steric selectivity



NUCLEODUR[®] phase overview



Application	Similar phases**	Interactions · retention mechanism
in general compounds with ionizable functional groups such as basic pharmaceuticals and pesticides	NUCLEOSIL [®] C ₁₈ HD Xterra [®] RP18 / MS C18; Luna [®] C18(2), Gemini [®] , Synergi [®] Max RP; Zorbax [®] Extend-C18; Inertsil [®] ODS III; Purospher [®] STAR RP-18; Hypersil [™] BDS	hydrophobic (van der Waals interactions)
overall sophisticated analytical separations, especially for polar compounds, e.g., antibiotics, water-soluble vitamins, organic acids	–	hydrophobic (van der Waals interactions) with additional polar interactions
like C ₁₈ Gravity, however, generally shorter retention times for nonpolar compounds	NUCLEOSIL [®] C ₈ HD Xterra [®] RP8 / MS C8; Luna [®] C8; Zorbax [®] Eclipse XDB-C8	hydrophobic (van der Waals interactions)
high steric selectivity, thus suited for separation of positional and structural isomers, planar / nonplanar molecules	NUCLEOSIL [®] C ₁₈ AB Inertsil [®] ODS-P; Pro C18 RS	steric and hydrophobic
basic pharmaceuticals, very polar compounds, organic acids	Aqua, Synergi [®] Hydro-RP; AQ; Atlantis [®] dC18; Polaris [®] C18-A	hydrophobic and polar (H bonds)
basic pharmaceuticals, organic acids, pesticides, amino acids, water-soluble vitamins	NUCLEOSIL [®] C ₁₈ Nautilus ProntoSIL [®] C18 AQ, Zorbax [®] Bonus-RP, Polaris [®] Amide-C18; Ascentis [®] RP Amide, SymmetryShield [™] RP18; SUPELCOSIL [™] LC-ABZ ⁺ ; HyPURITY [™] ADVANCE; ACCLAIM Polar AD.II	hydrophobic and polar (H bonds)
aromatic and unsaturated compounds, polar compounds like pharmaceuticals, antibiotics	Luna [®] Phenyl-Hexyl; Zorbax [®] Eclipse Plus Phenyl-Hexyl; Kromasil [®] Phenyl-Hexyl	π-π and hydrophobic
aromatic and unsaturated compounds, polar compounds like pharmaceuticals, antibiotics	Pinnacle [®] DB Biphenyl; Ultra Biphenyl	π-π and hydrophobic







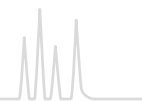





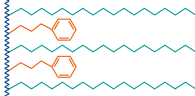

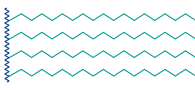
** phases which provide a similar selectivity based on chemical and physical properties

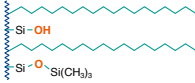

NUCLEODUR[®] phase overview

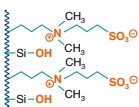

Overview of NUCLEODUR[®] HPLC phases

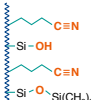
Phase	Specification	Page	Characteristic*	Stability	Structure
 PFP	pentafluorophenylpropyl, multi-endcapping 8% C · USP L43	174	A ●● B ●●●● C ●●●●	pH 1–9, suitable for LC/MS	NUCLEODUR [®] (Si-O) ₂ n 
 Sphinx RP	bifunctional, balanced ratio of propylphenyl and octadecyl, endcapping 15% C · USP L1 and L11	176	A ●●●● B ●●●● C ●	pH 1–10, suitable for LC/MS	NUCLEODUR [®] (Si-O) ₂ n 
 C ₁₈ HTec	octadecyl, high density coating, high capacity, multi-endcapping 18% C · USP L1	178	A ●●●●●● B ● C ●●●●	pH 1–11, suitable for LC/MS	NUCLEODUR [®] (Si-O) ₂ n 
 C ₁₈ ec	octadecyl, medium density, endcapping available in 110 Å and 300 Å pore size 17.5% / 4% C · USP L1	181	A ●●●●●● B ● C ●●●●●●	pH 1–9	NUCLEODUR [®] (Si-O) ₂ n 
 C ₈ ec	octyl, medium density, endcapping 10.5% C · USP L7	181	A ●●●● B ●●●● C ●●●●●●	pH 1–9	NUCLEODUR [®] (Si-O) ₂ n 
 C ₄ ec	butyl, medium density, endcapping, 300 Å pore size 2.5% C · USP L26	181	A ●●●● B ●●●● C ●●●●	pH 1–9	NUCLEODUR [®] (Si-O) ₂ n 
 HILIC	zwitterionic ammonium – sulfonic acid phase 7% C	184	A ● B ●●●●●● C -	pH 2–8.5	NUCLEODUR [®] (Si-O) ₂ n 
 CN/CN-RP	cyano (nitrile) for NP and RP separations 7% C · USP L10	186	A ● B ●●●●●● C -	pH 1–8, stable towards highly aqueous mobile phases	NUCLEODUR [®] (Si-O) ₂ n 

* A = ● hydrophobic selectivity, B = ● polar / ionic selectivity, C = ● steric selectivity

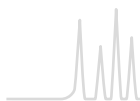

NUCLEODUR[®] phase overview



Application	Similar phases**	Interactions · retention mechanism
aromatic and unsaturated compounds, halogen compounds, phenols, isomers, polar pharmaceuticals, antibiotics	ACQUITY [®] CSH Fluoro-Phenyl; Hypersil [™] GOLD PFP; Luna [®] PFP(2); Discovery [®] HS F5; Allure [®] PFP Propyl; Ultra II PFP Propyl	polar (H bond), dipole-dipole, π - π and hydrophobic
compounds with aromatic and multiple bond systems	no similar phases	π - π and hydrophobic
robust and well base deactivated C ₁₈ phase; all separation tasks with preparative potential	Xterra [®] RP18 / MS C18 / SunFire [™] C18; Luna [®] C18(2), Gemini [®] , Synergi [®] Max RP; Zorbax [®] Extend-C18; Inertsil [®] ODS III; Purospher [®] STAR RP-18; Hypersil [®] BDS	hydrophobic (van der Waals interactions)
robust C ₁₈ phase for routine analyses	NUCLEOSIL [®] C ₁₈ Spherisorb [®] ODS II; Symmetry [®] C18; Hypersil [®] ODS; Inertsil [®] ODS II; Kromasil [®] C18; LiChrospher [®] RP-18	hydrophobic (van der Waals interactions) some residual silanol interactions
robust C ₈ phase for routine analyses	NUCLEOSIL [®] C ₈ ec / C ₈ Spherisorb [®] C8; Symmetry [®] C8; Hypersil [®] MOS; Kromasil [®] C8; LiChrospher [®] RP-8	hydrophobic (van der Waals interactions) some residual silanol interactions
biological macromolecules like proteins or peptides	Jupiter [®] C4; ACE [®] C4	hydrophobic (van der Waals interactions) some residual silanol interactions
hydrophilic compounds such as polar organic acids and bases, polar natural compounds	Sequant [™] ZIC [®] -HILIC; Obelisc [™]	ionic / hydrophilic and electrostatic
polar organic compounds (basic drugs), molecules containing π -electron systems	NUCLEOSIL [®] CN / CN-RP	π - π and polar (H bond), hydrophobic



** phases which provide a similar selectivity based on chemical and physical properties



NUCLEODUR[®] phase overview

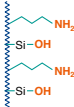

Overview of NUCLEODUR[®] HPLC phases

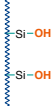
Phase	Specification	Page	Characteristic*	Stability	Structure
 NH ₂ /NH ₂ -RP	aminopropyl for NP and RP separations 2.5% C · USP L8	188	A ● B ●●●● C -	pH 2–8, stable towards highly aqueous mobile phases	NUCLEODUR [®] (Si-O) ₂ H 
 SiOH	unmodified high purity silica · USP L3	190	A - B - C -	pH 2–8	NUCLEODUR [®] (Si-O) ₂ H 

* A = ● hydrophobic selectivity, B = ● polar / ionic selectivity, C = ● steric selectivity

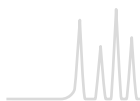

NUCLEODUR[®] phase overview

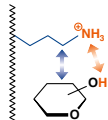
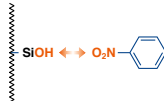

Application	Similar phases**	Interactions · retention mechanism
sugars, sugar alcohols and other hydroxy compounds, DNA bases, polar compounds in general	NUCLEOSIL [®] NH ₂ /NH ₂ -RP	polar / ionic and hydrophobic 
polar compounds in general	NUCLEOSIL [®] SiOH	polar / ionic 

** phases which provide a similar selectivity based on chemical and physical properties

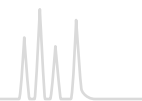

NUCLEODUR[®] C₁₈ Gravity · C₈ Gravity nonpolar high density phase · USP L1 (C₁₈) · USP L7 (C₈)

★ Key feature

- Suitable for LC/MS and HPLC at pH extremes (pH 1–11)
- Superior base deactivation
- Ideal for method development

🔧 Technical data

- Available as octadecyl (C₁₈) and octyl (C₈), multi-encapped
- Pore size 110 Å; particle sizes 1.8 µm, 3 µm and 5 µm for C₁₈, 1.8 and 5 µm for C₈; 7, 10, 12 and 16 µm particles for preparative purposes on request
- Carbon content 18 % for C₁₈, 11 % for C₈

✓ Recommended application

- Overall sophisticated analytical separations
- Compound classes separated include pharmaceuticals, e.g., analgesics, anti-inflammatory drugs, antidepressants; herbicides; phytopharmaceuticals; immunosuppressants

Base deactivation

NUCLEODUR[®] C₁₈ Gravity and NUCLEODUR[®] C₈ Gravity are based on the ultrapure NUCLEODUR[®] silica. Derivatization generates a homogeneous surface with a high density of bonded silanes (~18 % C for C₁₈, ~11 % C for C₈). Thorough endcapping suppresses any unwanted polar interactions between the silica surface and the sample, which makes “Gravity” particularly suitable for the separation of basic and other ionizable analytes. Even strongly basic pharmaceuticals like amitriptyline are eluted without tailing under isocratic conditions. For a discussion of the different retention behavior of C₁₈ phases compared to C₈ phases see page 182.

Enhanced pH stability

One major disadvantage of silica stationary phases is limited stability at strongly acidic or basic pH. Cleavage of the siloxane bonding by hydrolysis, or dissolution of the silica will rapidly lead to a considerable loss in column performance. Conventional RP phases are usually not recommended to be run with mobile phases at pH > 8 or pH < 2 for extended periods of time. The special surface bonding technology and the low concentration of trace elements of NUCLEODUR[®] C₁₈ and C₈ Gravity allow for use at an expanded pH range from pH 1 to 11.

Benefits of enhanced pH stability

An expanded pH range is often required in method development. Many nitrogen containing compounds like basic drugs are protonated at acidic or neutral pH and exhibit poor retention on a standard C₁₈ phase. The retention behavior can be improved by working at a higher pH, where the analyte is no longer protonated, but formally neutrally charged, as a rule between pH 9–10. For acidic analytes it is exactly in inverse proportion, maximum retention can be attained at low pH.

Surface silanols at different pH values

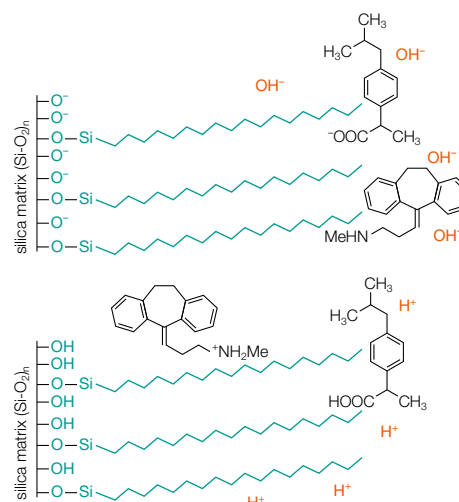

The figure above shows the extent of protonation of surface silanols and of two exemplary analytes at acidic and alkaline pH. The following graph explains the general correlation between retention and pH.

Correlation between retention and pH for basic and acidic compounds

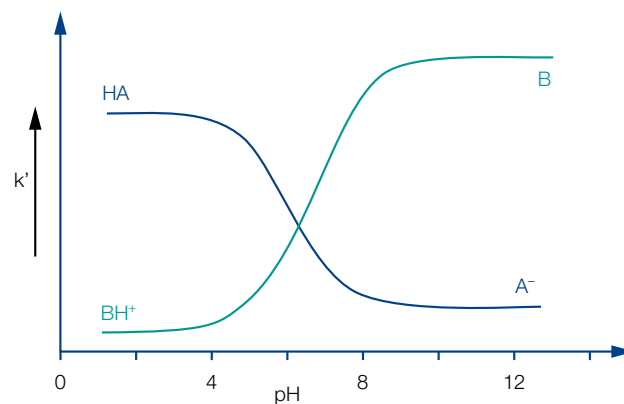



An example how selectivity can be controlled by pH is the separation of the acid ketoprofen, the base lidocaine and benzamide. Under acidic conditions the protonated lidocaine is eluted very fast due to lack of sufficiently strong hydrophobic interactions between analyte and C₁₈ chains, while the formally neutral keto- profen is eluted after about 3 min. However, at pH 10 a reversal of the elution order, with a visibly longer retention time for the basic lidocaine, is observed.

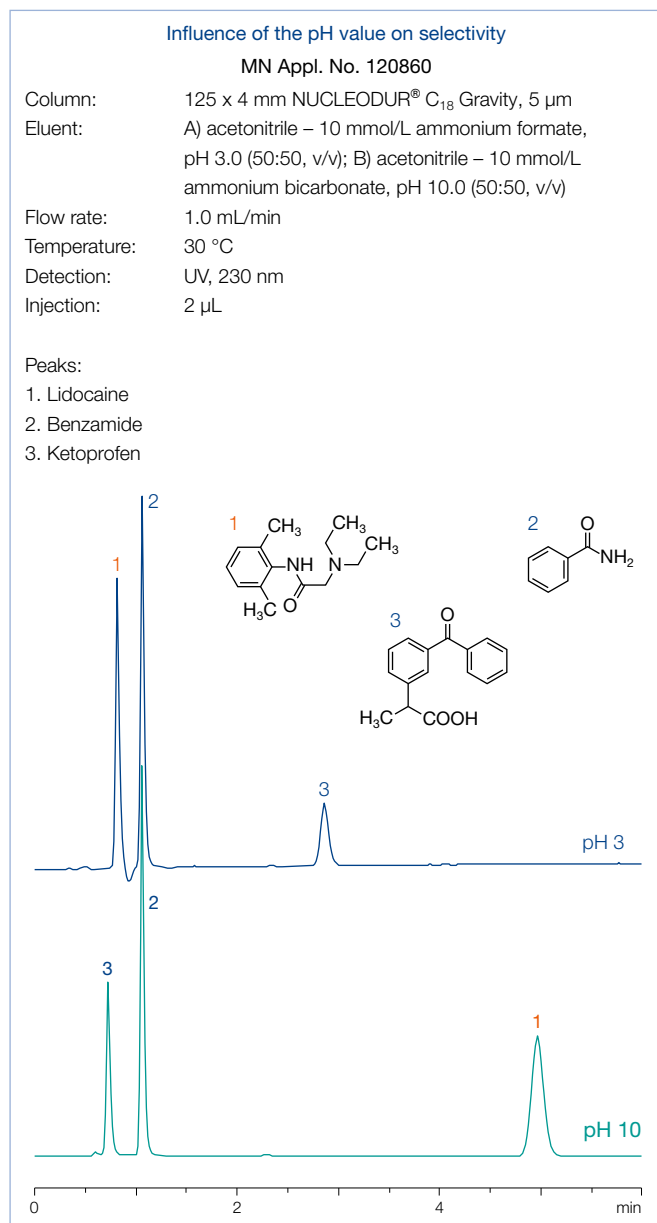

As mentioned above, pH stability of the stationary phase can be helpful for improving selectivity in method development. The following figure shows the separation of 4 basic drugs under acidic and basic conditions.

At pH 2.5 the protonated analytes exhibit poor retention (early elution) and in addition an inadequate resolution for papaverine and noscapine, whilst the formally non ionized molecules can be baseline separated due to the better retention pattern at alkaline pH.

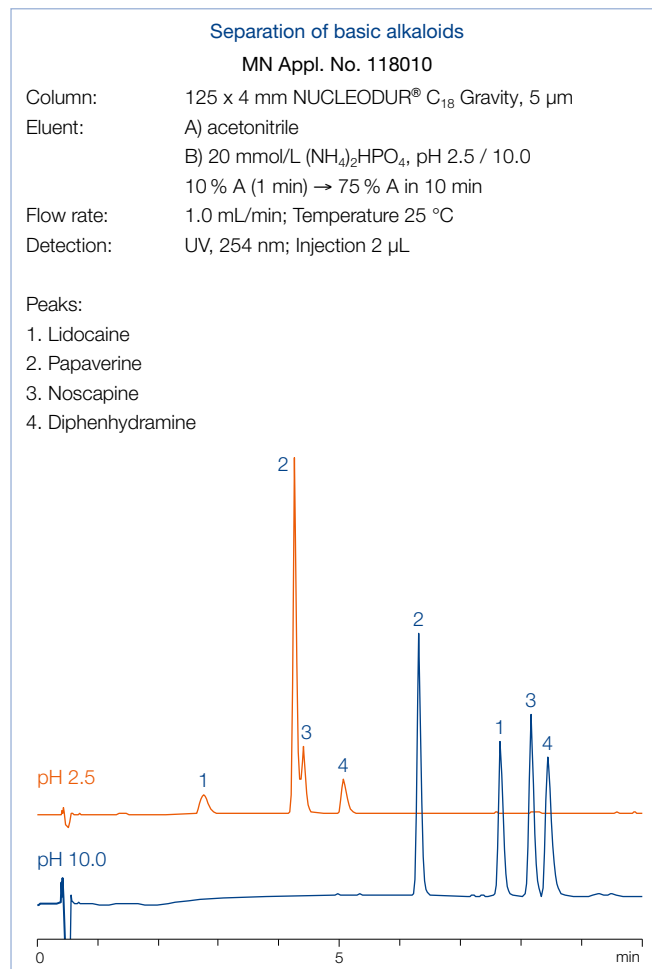

The following chromatogram demonstrates the stability of NUCLEODUR® C₁₈ Gravity under alkaline conditions. The ultra-pure Gravity with its unique high density surface bonding technology withstands strong alkaline mobile phase conditions.

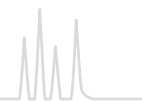

Stability of NUCLEODUR® C₁₈ Gravity at pH 11

MN Appl. No. 120850

Column: 50 x 4.6 mm NUCLEODUR® C₁₈ Gravity, 5 µm
 Eluent: methanol – water – ammonia (20:80:0.5, v/v/v), pH 11
 Flow rate: 1.3 mL/min
 Temperature: 30 °C
 Detection: UV, 254 nm
 Injection: 2.0 µL

Peaks:
 1. Theophylline
 2. Caffeine

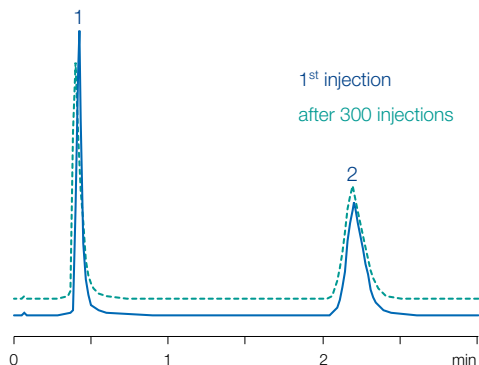

Even after 300 injections no loss of column efficiency – identified, e.g., by peak broadening or decrease in retention times – could be observed.

Under alkaline conditions dissolution of the silica support is possible, resulting in dead volume and thus peak broadening. It is worth mentioning, that this phenomenon also depends on type and concentration of buffers, as well as on the temperature. It is well known that the use of phosphate buffers, particularly at

elevated temperatures, can reduce column lifetime even at moderate pH. If possible, phosphate buffers should be replaced by less harmful alternatives.

The following chromatograms show the excellent column stability of NUCLEODUR® C₁₈ Gravity in acidic conditions. Retention times of all three compounds in the column performance test remain consistent and virtually unchanged, even after the column is run with 5000 mL eluent. Due to the extremely stable surface modification, no cleavage of the Si-O-Si bonding occurs, column deterioration is therefore successfully prevented.

Stability of NUCLEODUR® C₁₈ Gravity at pH 1.5

MN Appl. No. 120840

Column: 125 x 4 mm NUCLEODUR® C₁₈ Gravity, 5 µm
 Eluent: acetonitrile – 1 % TFA in water (50:50, v/v), pH 1.5
 Flow rate: 1.0 mL/min
 Temperature: 30 °C
 Detection: UV, 230 nm
 Injection: 5 µL

Peaks: 1. Pyridine, 2. Toluene, 3. Ethylbenzene

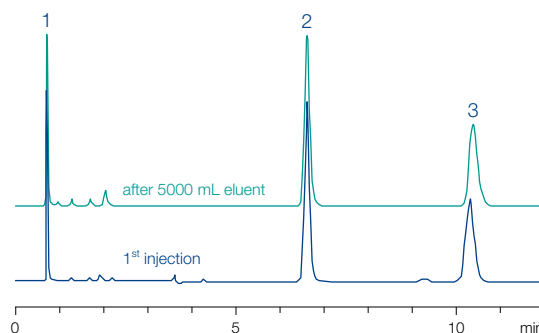

Ordering information

Eluent in column acetonitrile – water

ID	Length →						
	30 mm	50 mm	75 mm	100 mm	125 mm	150 mm	250 mm

NUCLEODUR® C₁₈ Gravity, 1.8 µm octadecyl phase, particle size 1.8 µm, 18 % C · UHPLC

Analytical EC columns

	2 mm	760078.20	760079.20	760071.20	760076.20		760075.20
	3 mm	760078.30	760079.30		760076.30		
	4 mm	760078.40	760079.40		760076.40		
	4.6 mm	760078.46	760079.46		760076.46		

EC guard columns*

4 x 2 mm: 761901.20 4 x 3 mm: 761901.30

NUCLEODUR® C₁₈ Gravity, 3 µm octadecyl phase, particle size 3 µm, 18 % C

Analytical EC columns

	2 mm		760080.20		760084.20	760081.20	760083.20	760082.20
	3 mm		760080.30		760084.30	760081.30	760083.30	760082.30
	4 mm		760080.40		760084.40	760081.40	760083.40	760082.40
	4.6 mm		760080.46	760086.46	760084.46	760081.46	760083.46	760082.46



EC guard columns*

4 x 2 mm: 761902.20 4 x 3 mm: 761902.30





Ordering information

Eluent in column acetonitrile – water

ID	Length →							
	30 mm	50 mm	75 mm	100 mm	125 mm	150 mm	250 mm	
NUCLEODUR® C₁₈ Gravity, 5 μm octadecyl phase, particle size 5 μm, 18 % C								
Analytical EC columns								
	2 mm	760102.20			760104.20	760100.20	760103.20	760101.20
	3 mm	760102.30			760104.30	760100.30	760103.30	760101.30
	4 mm	760102.40			760104.40	760100.40	760103.40	760101.40
	4.6 mm	760102.46	760106.46		760104.46	760100.46	760103.46	760101.46
EC guard columns*		4 x 2 mm: 761903.20		4 x 3 mm: 761903.30				
Preparative VarioPrep columns								
	10 mm	762103.100				762109.100		762113.100
	21 mm	762103.210				762109.210		762113.210
	32 mm							762113.320
	40 mm						762100.400	762113.400
VP guard columns ***		10 x 8 mm: 762160.80		10 x 16 mm: 762160.160		15 x 32 mm: 762163.320		
NUCLEODUR® C₁₈ Gravity, 10 μm octadecyl phase, particle size 10 μm, 18 % C								
Preparative VarioPrep columns								
	21 mm							762250.210
	40 mm							762250.400
VP guard columns **				10 x 16 mm: 762160.160		15 x 32 mm: 762163.320		

Ordering information

Eluent in column acetonitrile – water

ID	Length →							
	30 mm	50 mm	75 mm	100 mm	125 mm	150 mm	250 mm	
NUCLEODUR® C₈ Gravity, 1.8 μm octyl phase, particle size 1.8 μm, 11 % C · UHPLC								
Analytical EC columns								
	2 mm	760756.20	760755.20	760760.20	760757.20		760759.20	
	3 mm	760756.30	760755.30		760757.30			
	4 mm	760756.40	760755.40		760757.40			
	4.6 mm	760756.46	760755.46		760757.46			
EC guard columns*		4 x 2 mm: 761905.20		4 x 3 mm: 761905.30				
NUCLEODUR® C₈ Gravity, 5 μm octyl phase, particle size 5 μm, 11 % C								
Analytical EC columns								
	2 mm	760750.20			760754.20	760751.20	760752.20	760753.20
	3 mm	760750.30			760754.30	760751.30	760752.30	760753.30
	4 mm	760750.40			760754.40	760751.40	760752.40	760753.40
	4.6 mm	760750.46	760749.46		760754.46	760751.46	760752.46	760753.46
EC guard columns*		4 x 2 mm: 761907.20		4 x 3 mm: 761907.30				
Preparative VarioPrep columns								
	10 mm	762081.100				762071.100		762070.100
	21 mm	762081.210				762071.210	762082.210	762070.210
VP guard columns **		10 x 8 mm: 762097.80		10 x 16 mm: 762097.160				

EC and VarioPrep columns in packs of 1, guard columns see below.

Guard column systems

Guard columns for EC columns with ID		2 mm	3 mm	4 mm	4.6 mm	Guard column holder
* Column Protection System (pack of)	EC	4/2 (3)	4/3 (3)	4/3 (3)	4/3 (3)	718966
Guard columns for VarioPrep columns with ID		8, 10 mm	16, 21 mm	32, 40 mm	≥ 50 mm	
** VP guard columns (pack of)	VP	10/8 (2)	10/16 (2)	15/32 (1)	15/50 (1)	
VP guard column holder		718251	718256	718253	718255	

For details of our column systems see page 250.

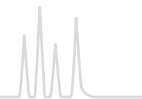

NUCLEODUR[®] C₁₈ Gravity-SB hydrophobic phase with polar selectivity · USP L1

★ Key feature

- Hydrophobic C₁₈ phase with distinct polar selectivity, ideal for method development, better retention of early eluting substances
- Excellent performance under highly aqueous conditions
- Suitable for LC/MS due to low bleeding characteristics

🔧 Technical data

- Monomeric octadecyl modification, extensive endcapping
- Pore size 110 Å; available particle sizes 1.8 µm, 3 µm and 5 µm; carbon content 13 %; pH stability 1–9

✓ Recommended application

- Overall sophisticated analytical separations, especially for polar compounds, e.g., antibiotics, water-soluble vitamins, organic acids

NUCLEODUR[®] C₁₈ Gravity-SB excels with a relatively high hydrophobicity – similar to C₁₈ Gravity – while simultaneously showing distinctive polar selectivity, without having polar embedded groups or polar endcapping. As a result the column displays better retention of early eluting analytes and high performance under strongly aqueous conditions. Additionally the column is suitable for LC/MS due to low bleeding characteristics. These features are achieved through side chains (isobutyl) of the monomeric C₁₈ phase.

In the TANAKA plot the NUCLEODUR[®] Gravity-SB shows similar hydrophobicity than the Gravity, however with a reduced capacity. The ion exchange capacity under basic conditions (pH 7.6) is high, which favors good retention of early eluting, polar substances.

Due to the broad selectivity and stability the base deactivated NUCLEODUR[®] C₁₈ Gravity-SB is versatile applicable, especially for polar analytes like nucleobases or pesticides the column shows good separation efficiency.

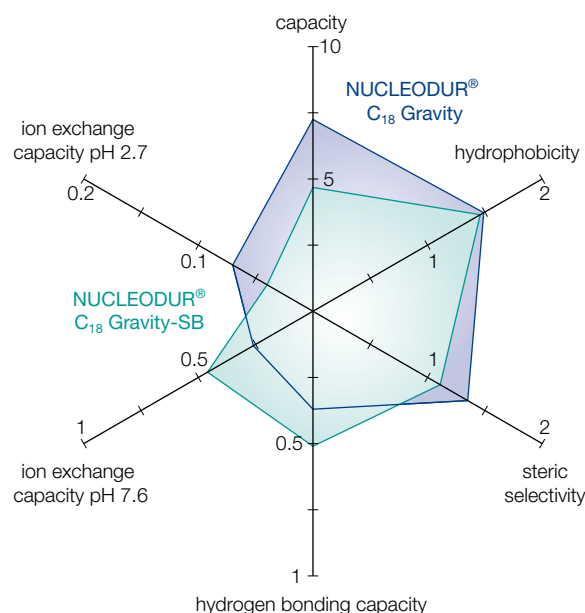

Pesticide mix (Ehrenstorfer, 17 components)

MN Appl. No. 127330

Column: EC 250/4.6 NUCLEODUR[®] C₁₈ Gravity-SB, 3 µm
 Eluent: A) acetonitrile
 B) 5 mmol/L NH₄Ac;
 10–37.5 % A in 50 min, 37.5–75 % A in 25 min
 Flow rate: 1.1 mL/min
 Temperature: 35 °C
 Detection: UV, 230 nm
 Injection: 3 µL

Peaks:

- | | | |
|-----------------------|------------------|-------------------|
| 1. Desethylatrazine | 7. Chlortoluron | 13. Metazachlor |
| 2. Metoxuron | 8. Atrazine | 14. Sebutylazin |
| 3. Hexazinone | 9. Monolinuron | 15. Terbutylazine |
| 4. Simazine | 10. Isoproturon | 16. Linuron |
| 5. Cyanazine | 11. Diuron | 17. Metolachlor |
| 6. Methabenzthiazuron | 12. Metobromuron | |

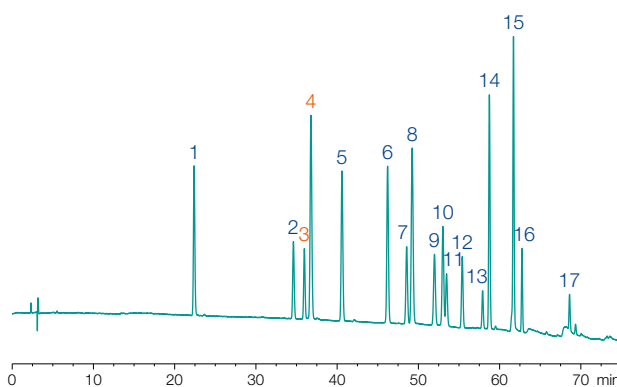

Good separation of the critical pair hexazinone/simazine



Comparing of selectivity for nucleobases

MN Appl. No. 127270

Columns: EC 150/4.6 mm
 NUCLEODUR® C₁₈ Gravity-SB, 5 µm
 NUCLEODUR® C₁₈ Gravity, 5 µm
 NUCLEODUR® C₁₈ Pyramid, 5 µm

Eluent: 25 mmol/L KH₂PO₄, pH 3 – methanol (95:5, v/v)
 Flow rate: 1.0 mL/min, Temperature: 20 °C
 Detection: UV, 220 nm, Injection: 2.5 µL (1 mg/mL)

Peaks:
 1. Cytosine 4. Guanine
 2. Adenine 5. Thymine
 3. Uracil

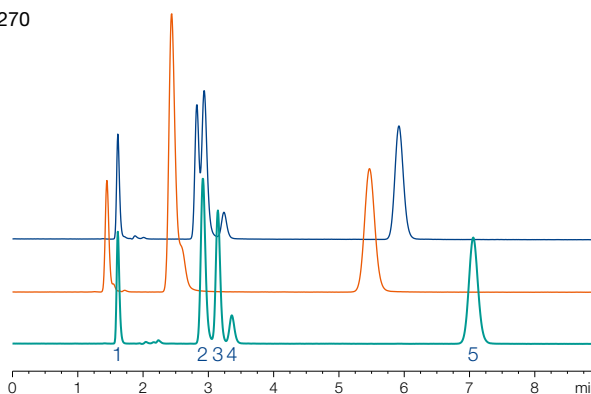

Better resolution of early eluting analyte

Ordering information

Eluent in column acetonitrile – water

ID	Length → 30 mm	50 mm	75 mm	100 mm	125 mm	150 mm	250 mm
----	-------------------	-------	-------	--------	--------	--------	--------

NUCLEODUR® C₁₈ Gravity-SB, 1.8 µm particle size 1.8 µm · UHPLC

Analytical EC columns

	2 mm	760591.20	760593.20	760595.20	760596.20		760598.20
	3 mm	760591.30	760593.30		760596.30		
	4 mm	760591.40	760593.40		760596.40		
	4.6 mm	760591.46	760593.46		760596.46		

EC guard columns* 4 x 2 mm: 761990.20 4 x 3 mm: 761990.30

NUCLEODUR® C₁₈ Gravity-SB, 3 µm particle size 3 µm

Analytical EC columns

	2 mm		760603.20		760606.20	760607.20	760608.20	760609.20
	3 mm		760603.30		760606.30	760607.30	760608.30	760609.30
	4 mm		760603.40		760606.40	760607.40	760608.40	760609.40
	4.6 mm		760603.46	760605.46	760606.46	760607.46	760608.46	760609.46

EC guard columns* 4 x 2 mm: 761991.20 4 x 3 mm: 761991.30

NUCLEODUR® C₁₈ Gravity-SB, 5 µm particle size 5 µm

Analytical EC columns

	2 mm		760613.20		760616.20	760617.20	760618.20	760619.20
	3 mm		760613.30		760616.30	760617.30	760618.30	760619.30
	4 mm		760613.40		760616.40	760617.40	760618.40	760619.40
	4.6 mm		760613.46	760615.46	760616.46	760617.46	760618.46	760619.46

EC guard columns* 4 x 2 mm: 761992.20 4 x 3 mm: 761992.30

Preparative VarioPrep columns

	10 mm		762350.100			762351.100		762353.100
	21 mm		762350.210			762351.210		762353.210
	32 mm							762353.320
	40 mm						762352.400	762353.400

VP guard columns** 10 x 8 mm: 762354.80 10 x 16 mm: 762354.160 15 x 32 mm: 762355.320

EC and VarioPrep columns in packs of 1, guard columns see below.

Guard column systems

Guard columns for EC columns with ID		2 mm	3 mm	4 mm	4.6 mm	Guard column holder
* Column Protection System (pack of)	EC	4/2 (3)	4/3 (3)	4/3 (3)	4/3 (3)	718966
Guard columns for VarioPrep columns with ID		8, 10 mm	16, 21 mm	32, 40 mm	≥ 50 mm	
** VP guard columns (pack of)	VP	10/8 (2)	10/16 (2)	15/32 (1)	15/50 (1)	
VP guard column holder		718251	718256	718253	718255	

For details of our column systems see page 250.



NUCLEODUR[®] C₁₈ Isis phase with high steric selectivity · USP L1

★ Key feature

- Exceptional steric selectivity
- Outstanding surface deactivation
- Suitable for LC/MS and HPLC at pH 1–10

🔧 Technical data

- C₁₈ phase with special polymeric, crosslinked surface modification; pore size 110 Å; particle sizes 1.8 μm, 3 μm and 5 μm; carbon content 20 %

✓ Recommended application

- Steroids, (*o,p,m*)-substituted aromatics, fat-soluble vitamins

Surface modification

By use of specific C₁₈ silanes and polymeric bonding technologies a dense shield of alkyl chains protects the subjacent silica matrix. Elemental analysis of NUCLEODUR[®] C₁₈ Isis shows a carbon load of 20 %. The target crosslinking of the C₁₈ chains on the surface enables the separation of compounds with similar molecular structure but different stereochemical properties. The technical term for this feature is steric selectivity.

Slot Model

Sander and Wise [5] proposed a model for the retention of aromatic compounds based on molecular shape, which is referred to as “Slot Model”. This model pictures the bonded C₁₈ phase on the silica surface with slots which the analytes have to penetrate during retention. Planar molecules are able to penetrate these slots deeper than non-planar molecules of similar molecular weight and length-to-width ratio. Thus triphenylene (lower structure) is longer retained than *o*-terphenyl (upper structure).

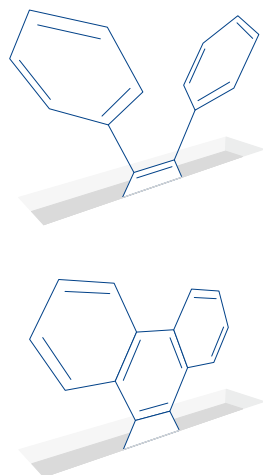

Steric selectivity

The following chromatograms reveal the improved resolution for positional isomers in a test mixture of aromatic compounds on NUCLEODUR[®] C₁₈ Isis (green) in direct comparison with monomerically coated (blue) and polar endcapped (orange) C₁₈ columns.

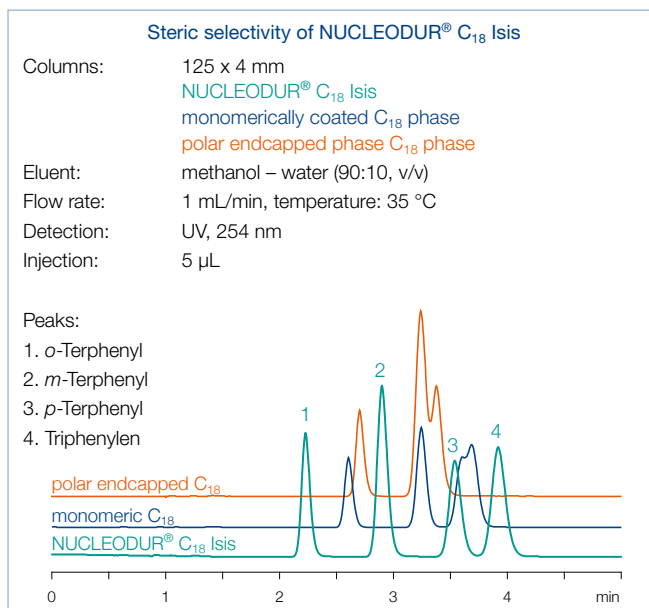

The separation of *o*-terphenyl and triphenylene is a good example to evaluate the selectivity of a RP column in terms of the shape of two molecules. The phenyl rings of *o*-terphenyl are twisted out of plane while triphenylene has a planar geometry. The separation factor α is a measure for the steric selectivity. As is shown below the α value is considerable larger on NUCLEODUR[®] C₁₈ Isis compared to a conventional C₁₈ column.

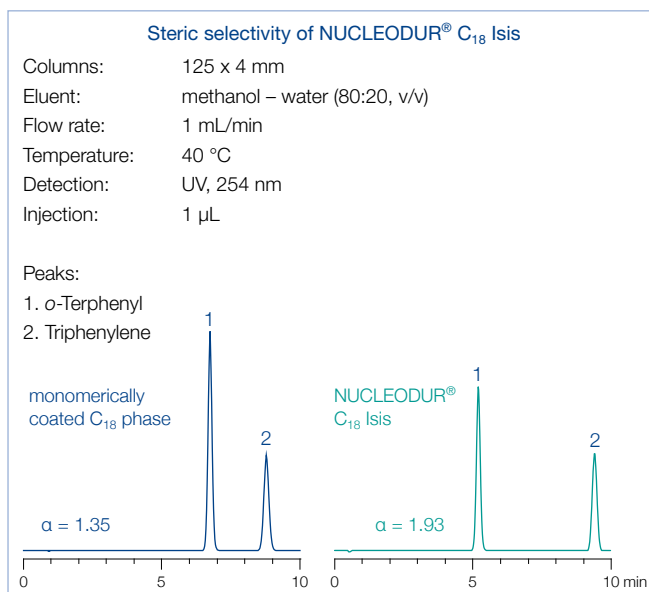

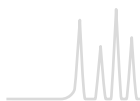





The surface bonding technology also provides improved stability features for the NUCLEODUR[®] C₁₈ Isis phase.

Surface deactivation

The chromatography of basic analytes requires a high density of surface-bonded C₁₈ silanes combined with a thorough endcapping procedure to keep silanol activity at a minimum. This ensures tailing-free elution of even strongly basic amino-containing compounds (see application 121210 at www.mn-net.com/apps).

Ordering information

Eluent in column acetonitrile – water

ID	Length → 30 mm							
		50 mm	75 mm	100 mm	125 mm	150 mm	250 mm	
NUCLEODUR[®] C₁₈ Isis, 1.8 μm particle size 1.8 μm · UHPLC								
Analytical EC columns								
	2 mm	760406.20	760405.20	760396.20	760407.20		760409.20	
	3 mm	760406.30	760405.30		760407.30			
	4 mm	760406.40	760405.40		760407.40			
	4.6 mm	760406.46	760405.46		760407.46			
EC guard columns*		4 x 2 mm: 761910.20		4 x 3 mm: 761910.30				
NUCLEODUR[®] C₁₈ Isis, 3 μm particle size 3 μm								
Analytical EC columns								
	2 mm		760400.20		760401.20	760402.20	760403.20	760404.20
	3 mm		760400.30		760401.30	760402.30	760403.30	760404.30
	4 mm		760400.40		760401.40	760402.40	760403.40	760404.40
	4.6 mm		760400.46	760397.46	760401.46	760402.46	760403.46	760404.46
EC guard columns*		4 x 2 mm: 761911.20		4 x 3 mm: 761911.30				
NUCLEODUR[®] C₁₈ Isis, 5 μm particle size 5 μm								
Analytical EC columns								
	2 mm		760410.20		760415.20	760412.20	760413.20	760414.20
	3 mm		760410.30		760415.30	760412.30	760413.30	760414.30
	4 mm		760410.40		760415.40	760412.40	760413.40	760414.40
	4.6 mm		760410.46	760416.46	760415.46	760412.46	760413.46	760414.46
EC guard columns*		4 x 2 mm: 761912.20		4 x 3 mm: 761912.30				
Preparative VarioPrep columns								
	10 mm		762404.100			762405.100		762403.100
	21 mm		762404.210			762405.210		762403.210
	32 mm							762403.320
	40 mm						762406.400	762403.400
VP guard columns**		10 x 8 mm: 762420.80		10 x 16 mm: 762420.160		15 x 32 mm: 762422.320		

EC and VarioPrep columns in packs of 1, guard columns see below.

Guard column systems

Guard columns for EC columns with ID		2 mm	3 mm	4 mm	4.6 mm	Guard column holder
* Column Protection System (pack of)	EC	4/2 (3)	4/3 (3)	4/3 (3)	4/3 (3)	718966
Guard columns for VarioPrep columns with ID		8, 10 mm	16, 21 mm	32, 40 mm	≥ 50 mm	
** VP guard columns (pack of)	VP	10/8 (2)	10/16 (2)	15/32 (1)	15/50 (1)	
VP guard column holder		718251	718256	718253	718255	

For details of our column systems see page 250.

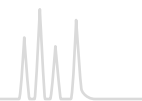

NUCLEODUR[®] C₁₈ Pyramid phase for highly aqueous eluents · USP L1

★ Key feature

- Stable in 100 % aqueous mobile phase systems
- Interesting polar selectivity features
- Excellent base deactivation; suitable for LC/MS due to low bleeding characteristics

🔧 Technical data

- Special phase with polar endcapping; pore size 110 Å; particle sizes 1.8 µm, 3 µm and 5 µm (7 and 10 µm particles for preparative purposes on request); carbon content 14 %; pH stability 1–9

✓ Recommended application

- Analgesics, penicillin antibiotics, nucleic acid bases, water-soluble vitamins, complexing agents, organic acids

RP-HPLC with highly aqueous mobile phases

The efforts to neutralize unwanted silanol activity often results in well base-deactivated RP phases with high carbon load, but a limited scope of selectivity beyond non-polar interactions. Polar compounds like carboxylic acids or drug metabolites show only weak retention on densely bonded RP columns due to distinct hydrophobic properties but low polar interactions. Very polar analytes require highly aqueous mobile phases for solubility and retention. Conventional reversed phase columns often display stability problems in eluent systems with high percentage of water (> 95 %) as evidenced by a sudden decrease of retention time and overall poor reproducibility. This phenomenon is described as phase collapse caused by the mobile phase expelled from the pores due to the fact, that hydrophobic RP phases are incompletely wetted with the mobile phase [6].

Different approaches can be used to increase column stability with highly aqueous mobile phase systems. The most promising concepts are incorporating a polar group in the hydrophobic alkyl chain, or using hydrophilic endcapping procedures to improve the wettability of the reversed phase modification. NUCLEODUR[®] PolarTec may be taken as an example for the embedded polar group strategy, in which a C₁₈ silane with a polar function is successfully linked to the silica surface.

Stability features

NUCLEODUR[®] C₁₈ Pyramid is a silica phase with hydrophilic endcapping, designed especially for use in eluent systems of up to 100 % water. The upper figure shows the retention behavior of tartaric, acetic and maleic acid under purely aqueous conditions on NUCLEODUR[®] C₁₈ Pyramid in comparison with a conventionally bonded C₁₈ phase.

It can be shown that the retention times for NUCLEODUR[®] C₁₈ Pyramid remain nearly unchanged between initial injection and restart after the flow has been stopped for 12 h, whilst the performance of the conventional RP column already collapsed totally after 5 min.

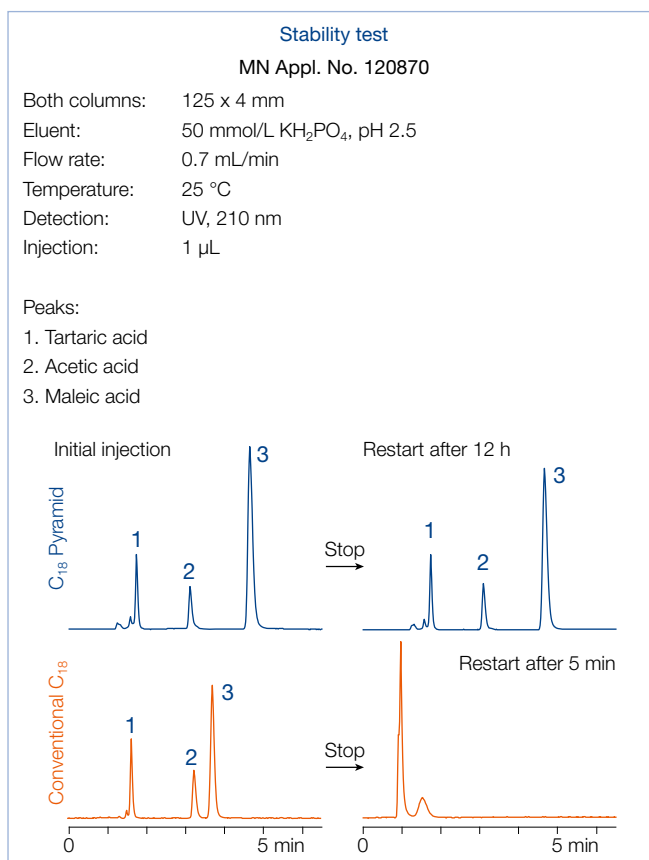

Retention characteristics

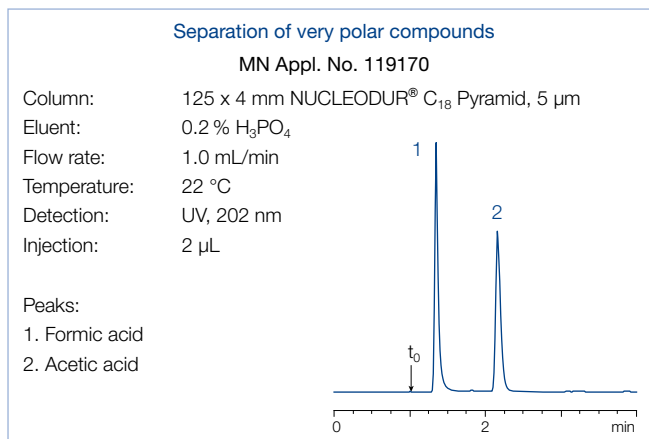

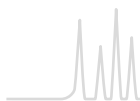





The polar surface exhibits retention characteristics different from conventional C₁₈ phases. Application 119170 shows the improved retention behavior of the very polar short chain organic acids, which are insufficiently retained on RP columns with predominantly hydrophobic surface properties. In addition to the exceptional polar selectivity NUCLEODUR® C₁₈ Pyramid also provides adequate hydrophobic retention (see applicati-

on No. 19190 at www.mn-net.com). The perceptible increase in polarity has no impact on the retention behavior of ionizable analytes. Even with the strongly basic compounds of the tricyclic antidepressant drug test mixture, no unwanted interactions or a so-called lack in base deactivation are observed (see application 119200 at www.mn-net.com/apps).

Ordering information

Eluent in column acetonitrile – water

ID	Length → 30 mm	50 mm	75 mm	100 mm	125 mm	150 mm	250 mm
NUCLEODUR® C₁₈ Pyramid, 1.8 μm particle size 1.8 μm · UHPLC							
Analytical EC columns							
	2 mm	760271.20	760272.20	760275.20	760273.20	760274.20	
	3 mm	760271.30	760272.30		760273.30		
	4 mm	760271.40	760272.40		760273.40		
	4.6 mm	760271.46	760272.46		760273.46		
EC guard columns*		4 x 2 mm: 761915.20		4 x 3 mm: 761915.30			
NUCLEODUR® C₁₈ Pyramid, 3 μm particle size 3 μm							
Analytical EC columns							
	2 mm	760263.20		760264.20	760260.20	760261.20	760262.20
	3 mm	760263.30		760264.30	760260.30	760261.30	760262.30
	4 mm	760263.40		760264.40	760260.40	760261.40	760262.40
	4.6 mm	760263.46	760259.46	760264.46	760260.46	760261.46	760262.46
EC guard columns*		4 x 2 mm: 761916.20		4 x 3 mm: 761916.30			
NUCLEODUR® C₁₈ Pyramid, 5 μm particle size 5 μm							
Analytical EC columns							
	2 mm	760200.20		760204.20	760201.20	760203.20	760202.20
	3 mm	760200.30		760204.30	760201.30	760203.30	760202.30
	4 mm	760200.40		760204.40	760201.40	760203.40	760202.40
	4.6 mm	760200.46	760205.46	760204.46	760201.46	760203.46	760202.46
EC guard columns*		4 x 2 mm: 761917.20		4 x 3 mm: 761917.30			
Preparative VarioPrep columns							
	10 mm	762271.100			762273.100		762272.100
	21 mm	762271.210			762273.210		762272.210
	32 mm						762272.320
	40 mm					762269.400	762272.400
VP guard columns**		10 x 8 mm: 762291.80		10 x 16 mm: 762291.160		15 x 32 mm: 762293.320	

EC and VarioPrep columns in packs of 1, guard columns see below.

Guard column systems

Guard columns for EC columns with ID		2 mm	3 mm	4 mm	4.6 mm	Guard column holder
* Column Protection System (pack of)	EC	4/2 (3)	4/3 (3)	4/3 (3)	4/3 (3)	718966
Guard columns for VarioPrep columns with ID		8, 10 mm	16, 21 mm	32, 40 mm	≥ 50 mm	
** VP guard columns (pack of)	VP	10/8 (2)	10/16 (2)	15/32 (1)	15/50 (1)	
VP guard column holder		718251	718256	718253	718255	

For details of our column systems see page 250.



NUCLEODUR[®] PolarTec RP phase with embedded polar group · USP L1 and L60

★ Key feature

- Excellent base deactivation
- Suitable for LC/MS and 100 % aqueous eluents
- Pronounced steric selectivity

🔧 Technical data

- Phase with embedded polar group; pore size 110 Å; particle sizes 1.8 µm, 3 µm and 5 µm; carbon content 17 %; pH stability 1–9

✓ Recommended application

- Exceptional selectivity for phenols and nitrogen containing compounds, polar compounds like basic pharmaceuticals, organic acids, pesticides, amino acids, water-soluble vitamins, etc.

RP-HPLC under 100 % aqueous conditions

The dominant form of interactions of conventional C₁₈ phases are nonpolar London dispersion forces. Besides nonpolar interactions phases with embedded polar groups possess the ability to show polar interactions (dipole-dipole, hydrogen bonds, π-π, etc.). These interactions enhance retention and selectivity for polar compounds like carboxylic acids, phenols and nitrogen containing compounds.

Due to the shielding effect of the embedded group NUCLEODUR[®] PolarTec shows an excellent base deactivation, which is at the top-notch of embedded polar group phases on the market. The pronounced steric selectivity (see Tanaka plot) is an additional tool for the separation of complex mixtures.

Due to low bleeding characteristics NUCLEODUR[®] PolarTec is also suitable for LC/MS.

Even after days or weeks of operation in purely aqueous eluents the C₁₈ chains of NUCLEODUR[®] PolarTec are neither folded nor show any collapsing. A significant reduction of retention time cannot be observed.

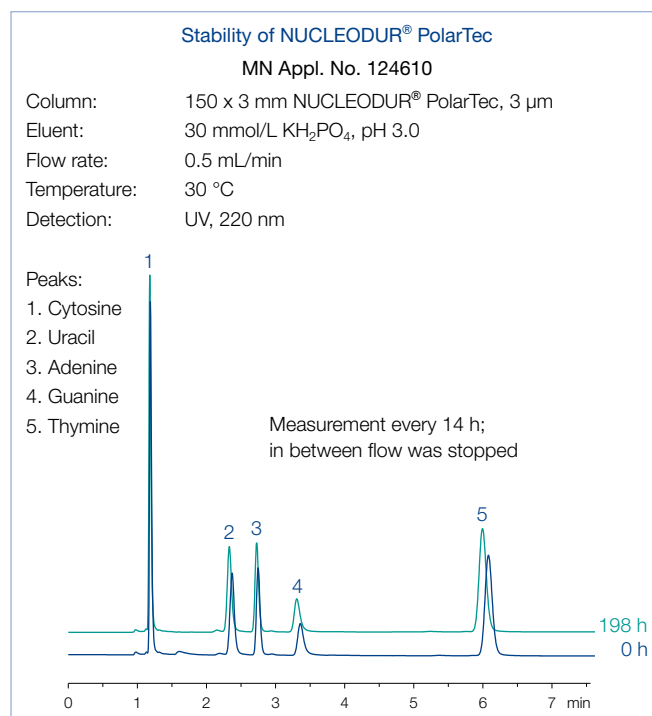
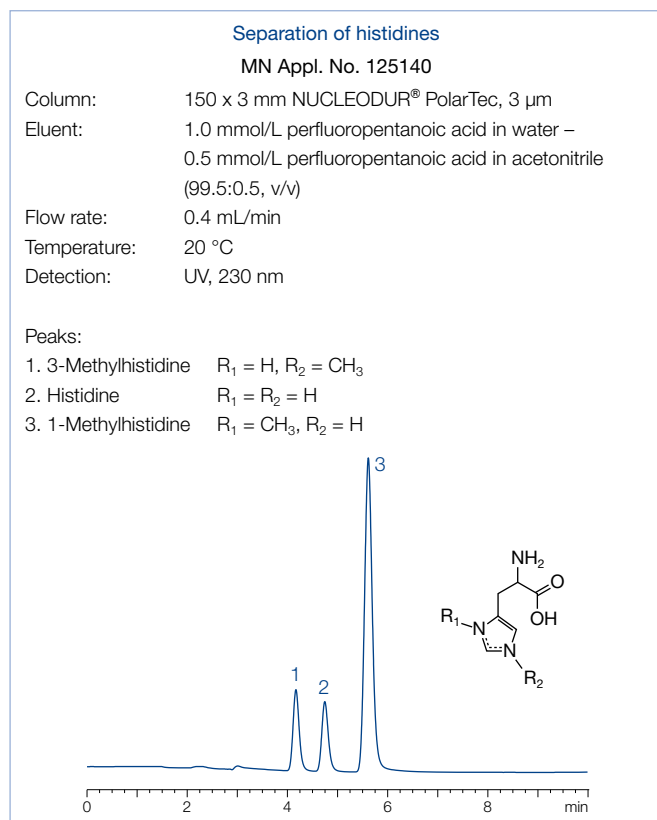

In order to increase retention for polar compounds it is often necessary to decrease the organic ratio of the mobile phase to zero. Under these conditions many conventional C₁₈ phases display the so-called dewetting effect which means that the mobile phase is expelled from the pores. This phenomenon leads to a dramatic loss in retention. NUCLEODUR[®] PolarTec is stable in 100 % aqueous mobile phases and therefore especially suited for the separation of polar compounds like organic acids.

In spite of the polar character of the embedded functional group NUCLEODUR[®] PolarTec exhibits sufficient hydrophobic properties and is very well suited for analyzing basic compounds.



Ordering information

Eluent in column acetonitrile – water

ID	Length →						
	30 mm	50 mm	75 mm	100 mm	125 mm	150 mm	250 mm

NUCLEODUR® PolarTec, 1.8 µm particle size 1.8 µm · UHPLC

Analytical EC columns

	2 mm	760461.20	760463.20	760465.20	760466.20		760468.20
	3 mm	760461.30	760463.30		760466.30		
	4 mm	760461.40	760463.40		760466.40		
	4.6 mm	760461.46	760463.46		760466.46		

EC guard columns*

4 x 2 mm: 761980.20 4 x 3 mm: 761980.30

NUCLEODUR® PolarTec, 3 µm particle size 3 µm

Analytical EC columns

	2 mm		760473.20		760476.20	760477.20	760478.20	760479.20
	3 mm		760473.30		760476.30	760477.30	760478.30	760479.30
	4 mm		760473.40		760476.40	760477.40	760478.40	760479.40
	4.6 mm		760473.46	760475.46	760476.46	760477.46	760478.46	760479.46

EC guard columns*

4 x 2 mm: 761981.20 4 x 3 mm: 761981.30

NUCLEODUR® PolarTec, 5 µm particle size 5 µm

Analytical EC columns

	2 mm		760483.20		760486.20	760487.20	760488.20	760489.20
	3 mm		760483.30		760486.30	760487.30	760488.30	760489.30
	4 mm		760483.40		760486.40	760487.40	760488.40	760489.40
	4.6 mm		760483.46	760485.46	760486.46	760487.46	760488.46	760489.46

EC guard columns*

4 x 2 mm: 761982.20 4 x 3 mm: 761982.30

Preparative VarioPrep columns

	10 mm		762220.100			762221.100		762223.100
	21 mm		762220.210			762221.210		762223.210
	32 mm							762223.320
	40 mm						762222.400	762223.400

VP guard columns**

10 x 8 mm: 762224.80 10 x 16 mm: 762224.160 15 x 32 mm: 762226.320

EC and VarioPrep columns in packs of 1, guard columns see below.

Guard column systems

Guard columns for EC columns with ID		2 mm	3 mm	4 mm	4.6 mm	Guard column holder
* Column Protection System (pack of)	EC	4/2 (3)	4/3 (3)	4/3 (3)	4/3 (3)	718966
Guard columns for VarioPrep columns with ID		8, 10 mm	16, 21 mm	32, 40 mm	≥ 50 mm	
** VP guard columns (pack of)	VP	10/8 (2)	10/16 (2)	15/32 (1)	15/50 (1)	
VP guard column holder		718251	718256	718253	718255	

For details of our column systems see page 250.

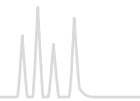

NUCLEODUR[®] Phenyl-Hexyl productive for polar/aromatic compounds · USP L11

★ Key feature

- Hydrophobic phase with alternative selectivity compared to classical C₁₈ modifications
- Separation principle based on 2 retention mechanisms: π-π interactions and hydrophobic interactions
- Suitable for LC/MS due to low bleeding characteristics

🔧 Technical data

- Phase with phenyl-hexyl modification and multi-endcapping; pore size 110 Å; particle sizes 1.8 μm, 3 μm and 5 μm; carbon content 10 %; pH stability 1–10

✓ Recommended application

- Aromatic and unsaturated compounds, polar compounds like pharmaceuticals, antibiotics

Phenylhexyl modified phases are an interesting alternative to classical C₁₈ phases due to an excellent separation of aromatic and unsaturated compounds especially with electron withdrawing groups.

The combination of hydrophobic and polar π-π interactions result in an interesting and alternate selectivity in comparison to C₁₈ and C₈ modified phases.

Through short phenylhexyl chains the NUCLEODUR[®] Phenyl-Hexyl is more polar than the bifunctional modified NUCLEODUR[®] Sphinx RP. Therefore shorter analysis times can be achieved with mixtures of structural similar aromatic and aliphatic unsaturated compounds.

With NUCLEODUR[®] Phenyl-Hexyl e.g., tricyclic antidepressants or water soluble vitamins can be separated in good resolution.

Separation of water-soluble vitamins on NUCLEODUR[®] Phenyl-Hexyl

MN Appl. No. 125920

Column: 100 x 3 mm NUCLEODUR[®] Phenyl-Hexyl, 3 μm
Eluent: A) 0.1 % phosphoric acid in water
B) 0.1 % phosphoric acid in acetonitrile
0 % B for 2 min, then to 60 % B in 7 min
Flow rate: 0.56 mL/min
Temperature: 35 °C
Detection: UV, 215 nm
Injection: 0.8 μL, 1.0 mg/mL each compound 1 mg/mL in eluent

- Peaks:
1. Thiamine
 2. Pyridoxine
 3. p-aminobenzoic acid
 4. Panthothenic acid
 5. Folic acid
 6. Biotin

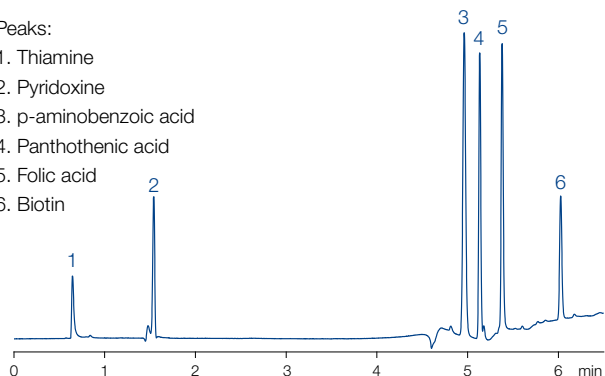

Tricyclic antidepressant (TCA)

MN Appl. No. 126020

Columns: 150 x 3 mm
NUCLEODUR[®] Phenyl-Hexyl, 3 μm
Agilent ZORBAX[®] Eclipse Phenyl-Hexyl, 3.5 μm
Phenomenex Luna[®] Phenyl-Hexyl, 3 μm
Eluent: A) 0.1 % formic acid in acetonitrile
B) 0.1 % formic acid in water
20–32.5 % A in 40 min
Flow rate: 0.56 mL/min
Temperature: 40 °C
Detection: UV, 254 nm
Injection: 0.2 μL, each compound 1 mg/mL in eluent

- Peaks:
1. Protriptyline
 2. Nortriptyline
 3. Imipramine
 4. Amitriptyline
 5. Trimipramine

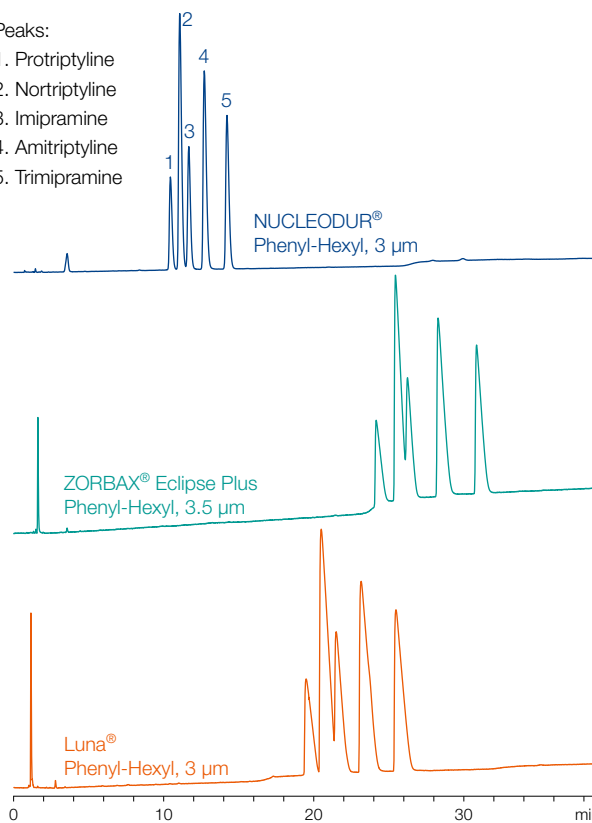



Ordering information

Eluent in column acetonitrile – water

ID	Length →							
	30 mm	50 mm	75 mm	100 mm	125 mm	150 mm	250 mm	

NUCLEODUR® Phenyl-Hexyl, 1.8 µm particle size 1.8 µm · UHPLC

Analytical EC columns

	2 mm	760561.20	760563.20	760565.20	760566.20		760568.20
	3 mm	760561.30	760563.30		760566.30		
	4 mm	760561.40	760563.40		760566.40		
	4.6 mm	760561.46	760563.46		760566.46		

EC guard columns*

4 x 2 mm: 761985.20 4 x 3 mm: 761985.30

NUCLEODUR® Phenyl-Hexyl, 3 µm particle size 3 µm

Analytical EC columns

	2 mm		760573.20		760576.20	760577.20	760578.20	760579.20
	3 mm		760573.30		760576.30	760577.30	760578.30	760579.30
	4 mm		760573.40		760576.40	760577.40	760578.40	760579.40
	4.6 mm		760573.46	760575.46	760576.46	760577.46	760578.46	760579.46

EC guard columns*

4 x 2 mm: 761986.20 4 x 3 mm: 761986.30

NUCLEODUR® Phenyl-Hexyl, 5 µm particle size 5 µm

Analytical EC columns

	2 mm		760583.20		760586.20	760587.20	760588.20	760589.20
	3 mm		760583.30		760586.30	760587.30	760588.30	760589.30
	4 mm		760583.40		760586.40	760587.40	760588.40	760589.40
	4.6 mm		760583.46	760585.46	760586.46	760587.46	760588.46	760589.46

EC guard columns*

4 x 2 mm: 761987.20 4 x 3 mm: 761987.30

Preparative VarioPrep columns

	10 mm		762210.100			762211.100		762213.100
	21 mm		762210.210			762211.210		762213.210
	32 mm							762213.320
	40 mm						762212.400	762213.400

VP guard columns**

10 x 8 mm: 762234.80 10 x 16 mm: 762234.160 15 x 32 mm: 762236.320

EC and VarioPrep columns in packs of 1, guard columns see below.

Guard column systems

Guard columns for EC columns with ID		2 mm	3 mm	4 mm	4.6 mm	Guard column holder
* Column Protection System (pack of)	EC	4/2 (3)	4/3 (3)	4/3 (3)	4/3 (3)	718966
Guard columns for VarioPrep columns with ID		8, 10 mm	16, 21 mm	32, 40 mm	≥ 50 mm	
** VP guard columns (pack of)	VP	10/8 (2)	10/16 (2)	15/32 (1)	15/50 (1)	
VP guard column holder		718251	718256	718253	718255	

For details of our column systems see page 250.

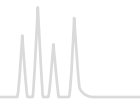

NUCLEODUR[®] π^2 hydrophobic biphenylpropyl phase · USP L11

★ Key feature

- Hydrophobic phase with alternative selectivity compared to classical C₁₈ modifications
- Separation principle based on 2 retention mechanisms (π - π interactions and hydrophobic interactions)
- Better retention of aromatic and unsaturated substances
- Excellent performance under highly aqueous conditions

🔧 Technical data

- Phase with biphenylpropyl modification and multi-endcapping; pore size 110 Å; particle size 5 μ m; carbon content 17 %; pH stability 1.5–10

✓ Recommended application

- Overall sophisticated analytical separations, especially aromatic and unsaturated compounds, polar compounds like pharmaceuticals, antibiotics, steroids

Stationary HPLC phases with biphenyl ligands like NUCLEODUR[®] π^2 provide an interesting alternative to classical alkyl modified C₁₈ and C₈ HPLC phases due to their remarkable orthogonal selectivity.

Furthermore the NUCLEODUR[®] π^2 provides an excellent separation performance for aromatic and unsaturated analytes by combination of hydrophobic and π - π interactions.

A unique feature is the predominant separation mechanism (π - π or hydrophobic interactions) and thus the selectivity can be controlled by selection of the eluent. In acetonitrile/water

NUCLEODUR[®] π^2 shows similar retention strength then C₁₈ modified phases and thereby displays a significantly stronger retention than phenyl phases. These interactions are even further enhanced in a methanol/water eluent.

NUCLEODUR[®] π^2 exceeds other aryl phases in terms of stability under strongly aqueous conditions. Therefore i.a. steroids, sulfonamides and acidic pharmaceuticals are separated in good resolution with NUCLEODUR[®] π^2 . NUCLEODUR[®] π^2 is the stationary phase with the highest aromatic analyte selectivity.

Sulfonamide antibiotics MN Appl. No. 127920

Columns: 100x3 mm each
NUCLEODUR[®] π^2 , 5 μ m
Pinnacle[®] DB Biphenyl, 5 μ m
Ultra Biphenyl, 5 μ m

Eluent: A) 0.1 % TFA in water
B) 0.1 % TFA in methanol
20 % B for 2 min, 20–60 % B in 2 min, 60 % B for 10 min

Flow rate: 0.56 mL/min
Temperature: 30 °C
Detection: UV, 280 nm
Injection: 1 μ L

Peaks:

1. Sulfathiazole
2. Sulfadiazine
3. Sulfachloropyridazine
4. Sulfamerazine
5. Sulfadimidine
6. Sulfamethoxazole
7. Sulfadimethoxine
8. Sulfaquinoxaline

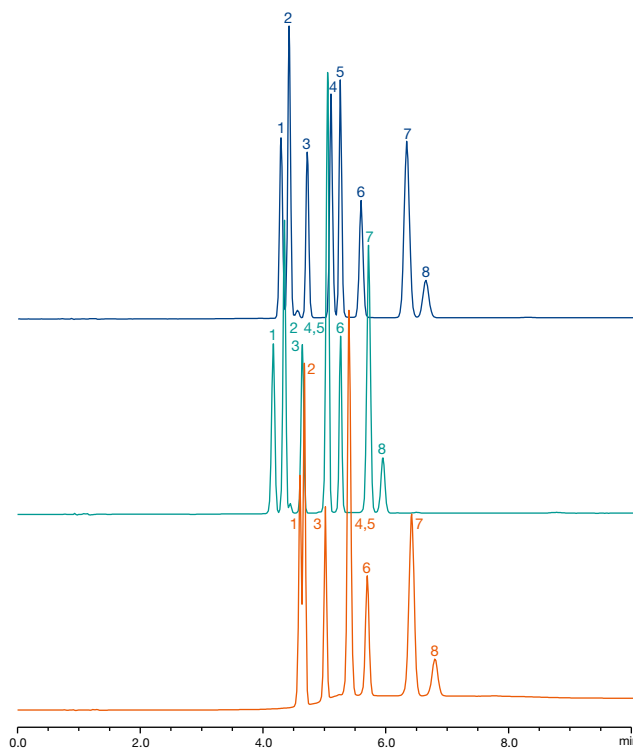



Steroids

MN Appl. No. 127910

Columns: 125 x 4 mm each
 NUCLEODUR® π², 5 μm
 NUCLEODUR® Phenyl-Hexyl, 5 μm
 NUCLEODUR® C₁₈ Gravity, 5 μm

Eluent: acetonitrile – water (45:55, v/v)
 Injection: 1 μL
 Flow rate: 1 mL/min
 Temperature: 25 °C
 Detection: UV, 230 nm

- Peaks:
1. Estriol
 2. Hydrocortisone
 3. Prednisone
 4. β-Estradiol
 5. Corticosterone
 6. Cortisonacetate
 7. Testosterone

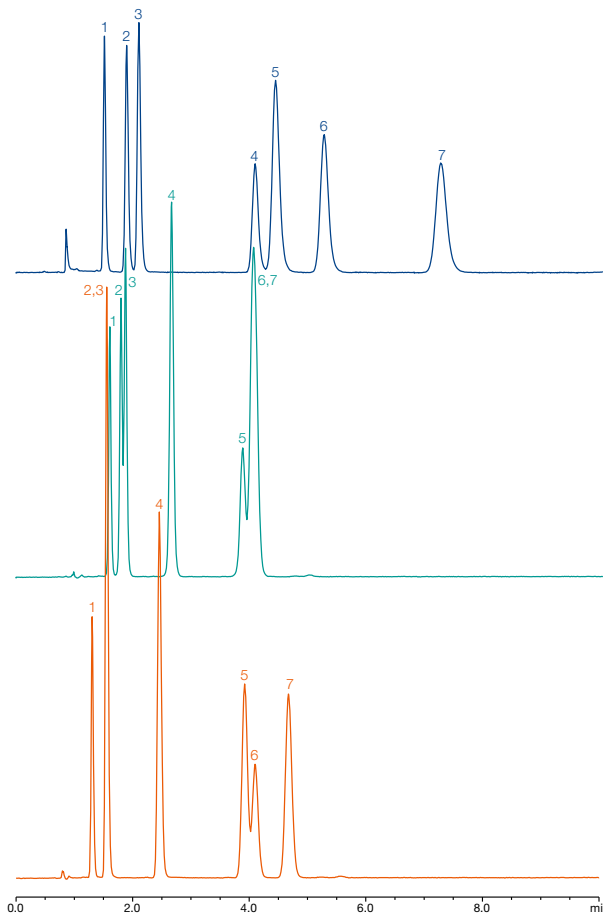

Ordering information

Eluent in column acetonitrile – water

ID	Length → 50 mm	75 mm	100 mm	125 mm	150 mm	250 mm	
NUCLEODUR® π², 5 μm particle size 5 μm							
Analytical EC columns							
	2 mm	760620.20	760621.20	760622.20	760623.20	760624.20	760625.20
	3 mm	760620.30	760621.30	760622.30	760623.30	760624.30	760625.30
	4 mm	760620.40	760621.40	760622.40	760623.40	760624.40	760625.40
	4.6 mm	760620.46	760621.46	760622.46	760623.46	760624.46	760625.46
EC guard columns*	4 x 2 mm: 761810.20		4 x 3 mm: 761810.30				

EC columns in packs of 1, guard columns in packs of 3.

Guard column systems

Guard columns for EC columns with ID	2 mm	3 mm	4 mm	4.6 mm	Guard column holder
* Column Protection System (pack of)	EC 4/2 (3)	4/3 (3)	4/3 (3)	4/3 (3)	718966

For details of our column systems see page 250.



NUCLEODUR[®] PFP hydrophobic pentafluorophenyl phase · USP L43

★ Key feature

- Hydrophobic phase with alternative selectivity in comparison to classical C₁₈ modifications
- Separation principle based on 4 retention mechanisms (polar interactions (H bonds), dipole-dipole, π-π, and hydrophobic interactions)
- Suitable for LC/MS due to low bleeding characteristics

🔧 Technical data

- Phase with pentafluorophenyl-propyl modification and multi-encapsulation; pore size 110 Å; particle sizes 1.8 μm, 3 μm and 5 μm; carbon content 8 %; pH stability 1–9

✓ Recommended application

- Aromatic and unsaturated compounds, phenols, halogen compounds, isomers, polar compounds like pharmaceuticals, antibiotics; strong retention of basic compounds

Orthogonality in selectivity

Fluorinated stationary phases in HPLC have gained increasing interest over the last years. Most common representative of fluorinated silica phases is the pentafluorophenyl modification (PFP or F₅). Especially the orthogonal selectivity compared to traditional alkyl phases widens the scope in analytical HPLC.

Thus NUCLEODUR[®] PFP offers an excellent selectivity especially for highly polar analytes like aromatic and unsaturated compounds, phenols or halogenated hydrocarbons.

While a typical C₁₈ phase just provides hydrophobic interactions between stationary phase and analyte NUCLEODUR[®] PFP offers four different retention mechanisms: polar interactions (H bonds), dipole-dipole, π-π, and hydrophobic interactions. Especially the pronounced ion exchange capacity and distinct steric selectivity are typical for fluorinated phases.

Due to low bleeding characteristics NUCLEODUR[®] PFP is also suitable for LC/MS. Based on a special surface modification procedure NUCLEODUR[®] PFP offers highest stability also at low pH values.

NUCLEODUR[®] PFP offers a completely different retention behavior compared to alkyl modified silica and is often used for separations which provide insufficient results on traditional C₁₈ phases.

Applications in the areas of (bio-)pharma, natural compounds and environment show the broad applicability of this phase.

Separation of antihistamines

MN Appl. No. 124861

Columns: 250 x 3 mm NUCLEODUR[®] PFP, 5 μm
250 x 3 mm NUCLEODUR[®] C₁₈ Gravity, 5 μm
Eluent: acetonitrile – 20 mmol/L KH₂PO₄ (30:70, v/v)
Flow rate: 1.3 mL/min
Temperature: 30 °C
Detection: UV, 210 nm

Peaks:

1. Maleic acid
2. Chlorpheniramine
3. Brompheniramine
4. Triprolidine
5. Diphenhydramine
6. Promethazine
7. Cetirizine
8. Hydroxyzine

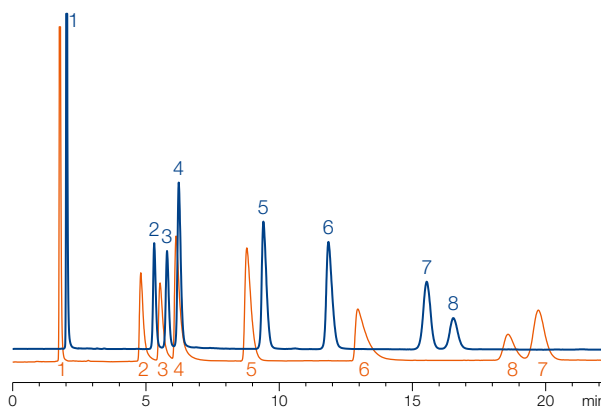



Separation of phenol isomers

MN Appl. No. 124531

Column: 125 x 4 mm NUCLEODUR® PFP, 5 µm
 125 x 4 mm NUCLEODUR® C₁₈ HTec, 5 µm
 Eluent: acetonitrile, 0.1 % formic acid – water, 0.1 %
 formic acid (35:65, v/v)
 Flow rate: 1 mL/min
 Temperature: 35 °C
 Detection: UV, 280 nm



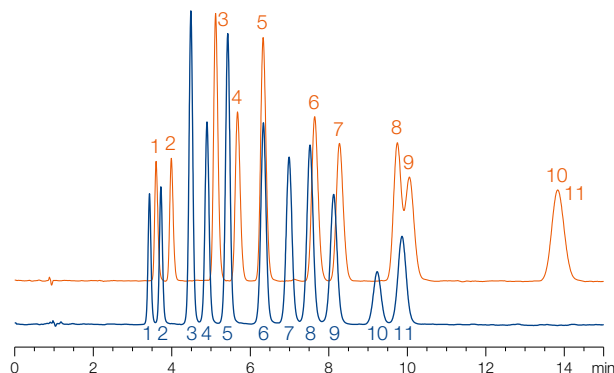

Peaks:

1. <i>o</i> -Kresol	5. 2,5-Dimethylphenol	9. 3,4-Dichlorophenol
2. <i>m</i> -Kresol	6. 2,6-Dichlorophenol	10. 2,4-Dibromophenol
3. 3,4-Dimethylphenol	7. 2,3-Dichlorophenol	11. 3,5-Dibromophenol
4. 3,5-Dimethylphenol	8. 2,4-Dichlorophenol	



Ordering information

Eluent in column acetonitrile – water

ID	Length → 30 mm	50 mm	75 mm	100 mm	125 mm	150 mm	250 mm
NUCLEODUR® PFP, 1.8 µm particle size 1.8 µm · UHPLC							
Analytical EC columns							
	2 mm	760431.20	760433.20	760435.20	760436.20	760438.20	
	3 mm	760431.30	760433.30		760436.30		
	4 mm	760431.40	760433.40		760436.40		
	4.6 mm	760431.46	760433.46		760436.46		
EC guard columns*		4 x 2 mm: 761975.20		4 x 3 mm: 761975.30			
NUCLEODUR® PFP, 3 µm particle size 3 µm							
Analytical EC columns							
	2 mm		760443.20		760446.20	760447.20	760448.20
	3 mm		760443.30		760446.30	760447.30	760448.30
	4 mm		760443.40		760446.40	760447.40	760448.40
	4.6 mm		760443.46	760445.46	760446.46	760447.46	760448.46
EC guard columns*		4 x 2 mm: 761976.20		4 x 3 mm: 761976.30			
NUCLEODUR® PFP, 5 µm particle size 5 µm							
Analytical EC columns							
	2 mm		760453.20		760456.20	760457.20	760458.20
	3 mm		760453.30		760456.30	760457.30	760458.30
	4 mm		760453.40		760456.40	760457.40	760458.40
	4.6 mm		760453.46	760455.46	760456.46	760457.46	760458.46
EC guard columns*		4 x 2 mm: 761977.20		4 x 3 mm: 761977.30			
Preparative VarioPrep columns							
	10 mm		762210.100		762211.100		762213.100
	21 mm		762210.210		762211.210		762213.210
	32 mm						762213.320
	40 mm					762212.400	762213.400
VP guard columns**		10 x 8 mm: 762214.80		10 x 16 mm: 762214.160		15 x 32 mm: 762216.320	
EC and VarioPrep columns in packs of 1, guard columns see below.							

Guard column systems

Guard columns for EC columns with ID		2 mm	3 mm	4 mm	4.6 mm	Guard column holder
* Column Protection System (pack of)	EC	4/2 (3)	4/3 (3)	4/3 (3)	4/3 (3)	718966
Guard columns for VarioPrep columns with ID		8, 10 mm	16, 21 mm	32, 40 mm	≥ 50 mm	
** VP guard columns (pack of)	VP	10/8 (2)	10/16 (2)	15/32 (1)	15/50 (1)	
VP guard column holder		718251	718256	718253	718255	

For details of our column systems see page 250.

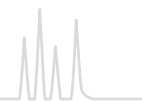

NUCLEODUR[®] Sphinx RP bifunctional RP phase · USP L1 and L11

★ Key feature

- Distinct selectivity based on well-balanced bifunctional surface coverage
- Widens the scope for method development based on additional π - π interactions
- Suitable for LC/MS due to low bleeding characteristics

🔧 Technical data

- Octadecyl and propylphenyl modified silica; pore size 110 Å; particle sizes 1.8 μ m, 3 μ m and 5 μ m; carbon content 15 %; pH stability 1–10; high reproducibility and consistent quality

✓ Recommended application

- Quinolone antibiotics, sulfonamides, xanthenes, substituted aromatics

Alternative RP selectivity

NUCLEODUR[®] Sphinx RP is characterized by exceptional selectivity features generated by a well-balanced ratio of covalently bonded octadecyl and phenyl groups. The combination of classical hydrophobic with π - π interactions (aromatic ring system) expands the scope of selectivity in comparison with conventional reversed phase packings. NUCLEODUR[®] Sphinx RP is particularly suited for the separation of molecules containing aromatic and multiple bonds.

For the separation of polar compounds NUCLEODUR[®] Sphinx RP can be especially recommended and can also outperform many customary C₁₈ phases. In addition, exhaustive endcapping steps minimize unwanted surface silanol activity and guarantee excellent peak shapes even for strong basic analytes.

Stability of NUCLEODUR[®] Sphinx RP at pH 10

MN Appl. No. 120900

Column: 50 x 4.6 mm NUCLEODUR[®] Sphinx RP, 5 μ m
 Eluent: methanol – dil. NH₃, pH 10 (20:80, v/v)
 Flow rate: 1.0 mL/min, temperature 30 °C
 Detection: UV, 275 nm
 Injection: 3 μ L

Peaks:
 1. Theophylline
 2. Caffeine

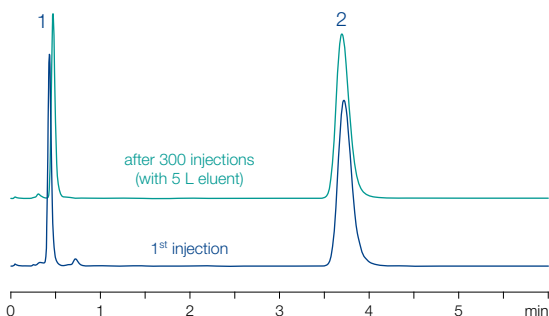

Different from standard phenyl phases, NUCLEODUR[®] Sphinx RP is far more stable towards hydrolysis, and is also suggested for LC/MS applications. Due to the additional intermolecular interactions NUCLEODUR[®] Sphinx RP is an interesting replenishment to the high density bonded phases NUCLEODUR[®] C₈/C₁₈ Gravity and the polar endcapped NUCLEODUR[®] C₁₈ Pyramid.

Separation of flavonoids on three different NUCLEODUR[®] phases

MN Appl. No. 119830

Columns: 150 x 4.6 mm
 NUCLEODUR[®] Sphinx RP, 5 μ m
 NUCLEODUR[®] C₁₈ Gravity, 5 μ m
 NUCLEODUR[®] C₈ Gravity, 5 μ m
 Eluent: water – methanol (40:60, v/v)
 Flow rate: 1 mL/min
 Temperature: 30 °C
 Detection: UV, 270 nm
 Injection: 3 μ L

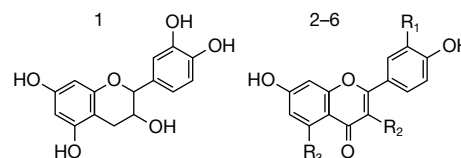

Peaks:
 1. Catechin
 2. Rutin R₁ = R₃ = OH, R₂ = O-Rutinoside
 3. Fisetin R₁ = R₂ = OH, R₃ = H
 4. Quercetin R₁ = R₂ = R₃ = OH
 5. Kaempferol R₁ = H, R₂ = R₃ = OH
 6. Isorhamnetin R₁ = OCH₃, R₂ = R₃ = OH

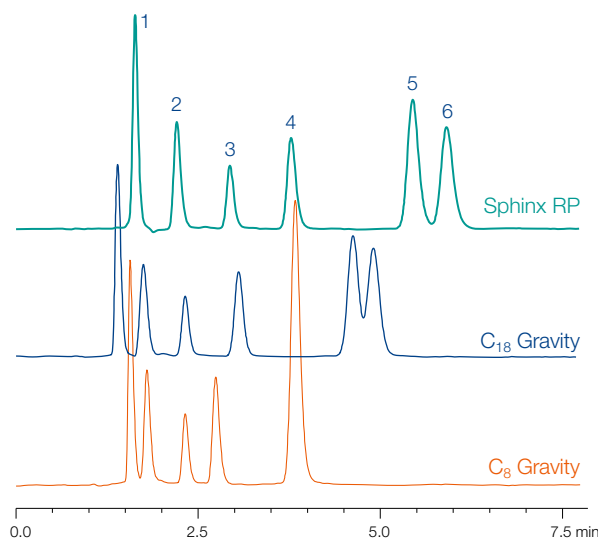



Ordering information

Eluent in column acetonitrile – water

ID	Length →						
	30 mm	50 mm	75 mm	100 mm	125 mm	150 mm	250 mm

NUCLEODUR® Sphinx RP, 1.8 µm particle size 1.8 µm · UHPLC

Analytical EC columns

	2 mm	760821.20	760822.20	760825.20	760823.20	760824.20	
	3 mm	760821.30	760822.30		760823.30		
	4 mm	760821.40	760822.40		760823.40		
	4.6 mm	760821.46	760822.46		760823.46		

EC guard columns*

4 x 2 mm: 761920.20 4 x 3 mm: 761920.30

NUCLEODUR® Sphinx RP, 3 µm particle size 3 µm

Analytical EC columns

	2 mm	760806.20		760812.20	760807.20	760805.20	760808.20
	3 mm	760806.30		760812.30	760807.30	760805.30	760808.30
	4 mm	760806.40		760812.40	760807.40	760805.40	760808.40
	4.6 mm	760806.46	760813.46	760812.46	760807.46	760805.46	760808.46

EC guard columns*

4 x 2 mm: 761921.20 4 x 3 mm: 761921.30

NUCLEODUR® Sphinx RP, 5 µm particle size 5 µm

Analytical EC columns

	2 mm	760800.20		760809.20	760801.20	760802.20	760803.20
	3 mm	760800.30		760809.30	760801.30	760802.30	760803.30
	4 mm	760800.40		760809.40	760801.40	760802.40	760803.40
	4.6 mm	760800.46	760815.46	760809.46	760801.46	760802.46	760803.46

EC guard columns*

4 x 2 mm: 761922.20 4 x 3 mm: 761922.30

Preparative VarioPrep columns

	10 mm	762372.100		762375.100		762373.100	
	21 mm	762372.210		762375.210		762373.210	
	32 mm						762373.320
	40 mm						762373.400

VP guard columns**

10 x 8 mm: 762390.80 10 x 16 mm: 762390.160 15 x 32 mm: 762392.320

EC and VarioPrep columns in packs of 1, guard columns see below.

Guard column systems

Guard columns for EC columns with ID		2 mm	3 mm	4 mm	4.6 mm	Guard column holder
* Column Protection System (pack of)	EC	4/2 (3)	4/3 (3)	4/3 (3)	4/3 (3)	718966
Guard columns for VarioPrep columns with ID		8, 10 mm	16, 21 mm	32, 40 mm	≥ 50 mm	
** VP guard columns (pack of)	VP	10/8 (2)	10/16 (2)	15/32 (1)	15/50 (1)	
VP guard column holder		718251	718256	718253	718255	

For details of our column systems see page 250.

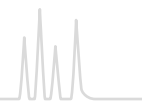

NUCLEODUR[®] C₁₈ HTec base-deactivated preparative octadecyl phase · USP L1

★ Key feature

- Reliable and durable standard RP phase for up-scaling to preparative scale, suited for LC/MS
- High loading capacity and excellent stability
- Outstanding base deactivation

🔧 Technical data

- High density octadecyl modification (C₁₈); pore size 110 Å; particle sizes 1.8 µm, 3 µm, 5 µm, 7 µm and 10 µm for analytical and preparative separations; carbon content 18 %, pH stability 1–11

✓ Recommended application

- Sophisticated analytical and preparative separations of basic, neutral and acidic pharmaceuticals, derivatized amino acids, pesticides, fat-soluble vitamins, aldehydes, ketones and phenolic compounds

Preparative separations place high demands on silica based HPLC materials. Apart from excellent selectivity and base deactivation, robustness (pH, pressure stability, ...) and capacity are vital criteria for optimal and efficient separation at the preparative scale.

Selectivity and base deactivation

The innovative endcapping procedure leads to exceptionally good base deactivation – the Engelhardt test demonstrates superb selectivity, peak symmetry and peak shape over the entire polarity range. In addition NUCLEODUR[®] C₁₈ HTec scores in low bleed characteristics and is therefore highly suitable for LC/MS.

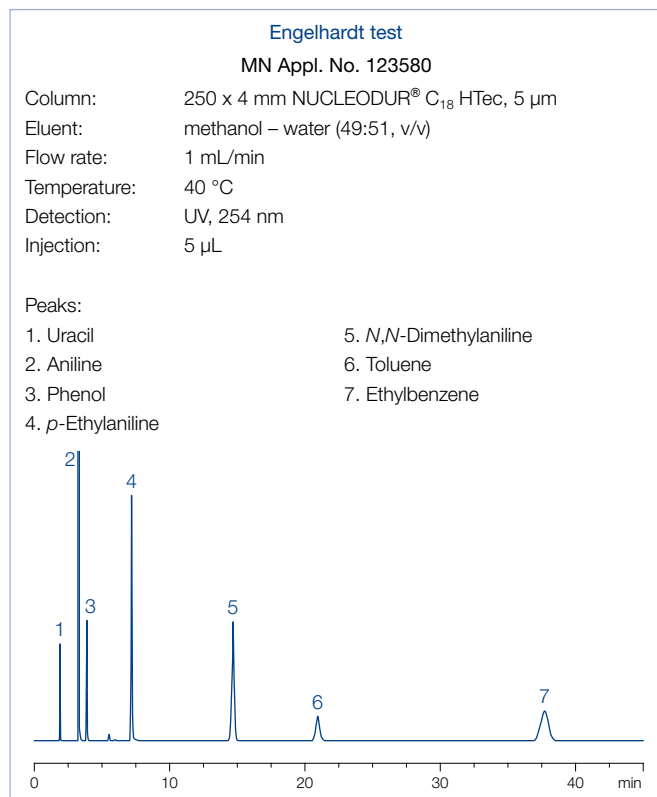

Stability and lifetime

Based on fully synthetic and extremely robust totally spherical NUCLEODUR[®] silica, NUCLEODUR[®] C₁₈ HTec offers outstanding mechanical rigidity and is thus the perfect choice also for self-packing of prep-columns. The special surface modification and endcapping procedure results in high chemical stability even at extreme chromatographic conditions like high flow rates, temperature or critical solvents (DMSO). Furthermore, NUCLEODUR[®] C₁₈ HTec columns show a remarkably long lifetime in acidic (pH 1) as well as basic (pH 10) mobile phases.

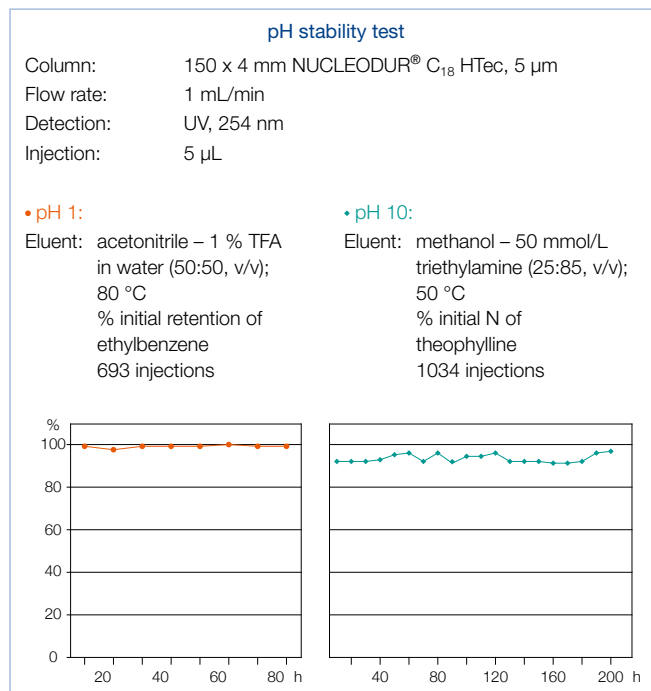

Due to innovative surface coating procedures NUCLEODUR[®] C₁₈ HTec offers excellent analytical separation properties and is the first choice for up-scaling to preparative column dimensions.

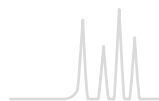

Up-scaling

Due to highest quality standards in silica production and phase chemistry combined with optimized packing technology, NUCLEODUR[®] C₁₈ HTec allows exceptional transferability from analytical to preparative scale with respect to different particle sizes (e.g., 5, 7 or 10 µm) as well as column dimensions (e.g., ID 4.6 to 21 mm).

Up-scaling with NUCLEODUR[®] C₁₈ HTec

MN Appl. No. 123780

Columns: EC 250 x 4,6 mm NUCLEODUR[®] C₁₈ HTec, 5 µm
 VP 250 x 21 mm NUCLEODUR[®] C₁₈ HTec, 5 µm
 Eluent: acetonitrile – water (80:20, v/v)
 Flow rate: 1.3 mL/min / 27 mL/min
 Temperature: 22 °C
 Pressure: 84 bar / 109 bar
 Detection: UV, 254 nm
 Injection: 3 µL / 60 µL

Peaks: (1 mg/mL each)

1. Phenol
2. Naphthalene
3. Anthracene

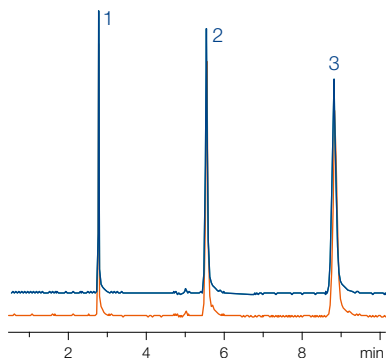

Capacity

A vital criterion for efficiency in preparative HPLC is the capacity of the separation medium. NUCLEODUR[®] C₁₈ HTec is characterized by a notably high loading capacity under both basic and acidic conditions, while competitor columns show overload effects even at lower loads (x).

Loading capacity under acidic conditions

MN Appl. No. 123890

Columns: VP 100 x 21 mm NUCLEODUR[®] C₁₈ HTec, 5 µm
 100 x 21.2 mm AXIA™ Gemini[®] 5 µm C18 110 Å
 Eluent: acetonitrile – formic acid in H₂O pH 3.0
 (30:70, v/v)
 Flow rate: 28 mL/min
 Temperature: 22 °C
 Pressure: 124 bar
 Detection: UV, 254 nm

Peaks:

- total load 40 mg
 (sample dissolved in DMSO)
1. 4-Acetamidophenol (5 mg)
 2. 2-Acetamidophenol (10 mg)
 3. Acetylsalicylic acid (25 mg)

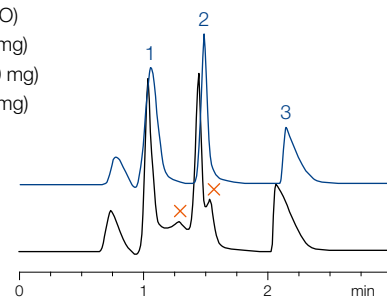

Ordering information

Eluent in column acetonitrile – water

ID	Length →	30 mm	50 mm	75 mm	100 mm	125 mm	150 mm	250 mm
----	----------	-------	-------	-------	--------	--------	--------	--------

NUCLEODUR[®] C₁₈ HTec, 1.8 µm particle size 1.8 µm · UHPLC

Analytical EC columns

	2 mm	760301.20	760305.20	760304.20	760306.20		760308.20	
	3 mm	760301.30	760305.30		760306.30			
	4 mm	760301.40	760305.40		760306.40			
	4.6 mm	760301.46	760305.46		760306.46			

EC guard columns*

4 x 2 mm: 761925.20 4 x 3 mm: 761925.30

NUCLEODUR[®] C₁₈ HTec, 3 µm particle size 3 µm

Analytical EC columns

	2 mm	760321.20		760323.20	760324.20	760325.20	760326.20
	3 mm	760321.30		760323.30	760324.30	760325.30	760326.30
	4 mm	760321.40		760323.40	760324.40	760325.40	760326.40
	4.6 mm	760321.46	760322.46	760323.46	760324.46	760325.46	760326.46

EC guard columns*

4 x 2 mm: 761926.20 4 x 3 mm: 761926.30

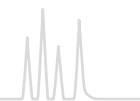

Ordering information

Eluent in column acetonitrile – water

ID	Length →							
	30 mm	50 mm	75 mm	100 mm	125 mm	150 mm	250 mm	

NUCLEODUR[®] C₁₈ HTec, 5 μm particle size 5 μm

Analytical EC columns

	2 mm	760311.20		760313.20	760314.20	760315.20	760316.20
	3 mm	760311.30		760313.30	760314.30	760315.30	760316.30
	4 mm	760311.40		760313.40	760314.40	760315.40	760316.40
	4.6 mm	760311.46	760312.46	760313.46	760314.46	760315.46	760316.46

EC guard columns*

4 x 2 mm: 761927.20 4 x 3 mm: 761927.30

Preparative VarioPrep columns

	10 mm	762551.100			762554.100		762556.100
	21 mm	762551.210		762553.210	762554.210		762556.210
	32 mm			762553.320		762555.320	762556.320
	40 mm					762555.400	762556.400
	50 mm			762553.500		762555.500	762556.500

VP guard columns**

10 x 8 mm: 762591.80 10 x 16 mm: 762591.160
15 x 32 mm: 762592.320 15 x 50 mm: 762592.500

NUCLEODUR[®] C₁₈ HTec, 7 μm particle size 7 μm

Preparative VarioPrep columns

	10 mm	762561.100			762564.100		762566.100
	21 mm	762561.210		762563.210	762564.210		762566.210
	32 mm			762563.320		762565.320	762566.320
	40 mm					762565.400	762566.400
	50 mm			762563.500		762565.500	762566.500

VP guard columns**

10 x 8 mm: 762591.80 10 x 16 mm: 762591.160
15 x 32 mm: 762592.320 15 x 50 mm: 762592.500

NUCLEODUR[®] C₁₈ HTec, 10 μm particle size 10 μm

Preparative VarioPrep columns

	10 mm	762571.100			762574.100		762576.100
	21 mm	762571.210		762573.210	762574.210		762576.210
	32 mm			762573.320		762575.320	762576.320
	40 mm					762575.400	762576.400
	50 mm			762573.500		762575.500	762576.500

VP guard columns**

10 x 8 mm: 762591.80 10 x 16 mm: 762591.160
15 x 32 mm: 762592.320 15 x 50 mm: 762592.500

EC and VarioPrep columns in packs of 1, guard columns see below.

Guard column systems

Guard columns for EC columns with ID		2 mm	3 mm	4 mm	4.6 mm	Guard column holder
* Column Protection System (pack of)	EC	4/2 (3)	4/3 (3)	4/3 (3)	4/3 (3)	718966
Guard columns for VarioPrep columns with ID		8, 10 mm	16, 21 mm	32, 40 mm	≥ 50 mm	
** VP guard columns (pack of)	VP	10/8 (2)	10/16 (2)	15/32 (1)	15/50 (1)	
VP guard column holder		718251	718256	718253	718255	

For details of our column systems see page 250.

NUCLEODUR[®] C₁₈ HTec bulk material in 7 and 10 μm for self-packing of preparative columns see page 256.



NUCLEODUR® C₁₈ ec · C₈ ec · C₄ ec nonpolar phases for routine analysis · USP L1 (C₁₈) · L7 (C₈) · L26 (C₄)

★ Key feature

- Ideal and reliable standard RP phase for daily routine analysis and up-scaling for preparative HPLC
- Medium density Octadecyl (C₁₈) and octyl (C₈) with pore size of 110 Å with exhaustive endcapping for a wide range of applications
- Octadecyl (C₁₈) and butyl (C₄) with pore size of 300 Å for the separation of biomolecules

🔧 Technical data

- Pore size 110 Å:
particle sizes 3 µm and 5 µm, 7 µm, 10 µm, 12 µm, 16 µm, 20 µm, 30 µm and 50 µm for preparative separations; carbon content 17.5 % for C₁₈, 10.5 % for C₈; pH stability 1–9; high reproducibility from lot to lot
- Pore size 300 Å:
technical data and applications in chapter “HPLC column for biochemical separations” (see page 241)

✓ Recommended application

- 110 Å:
basic, neutral or acidic drugs; derivatized amino acids; pesticides; fat-soluble vitamins; aldehydes and ketones; phenolic compounds
- 300 Å:
biomolecular macromolecules, like proteins and peptides

NUCLEODUR® C₁₈ ec for daily routine analysis

The efficiency of a separation is controlled by particle size and selectivity of the stationary phase. The exceptional surface coverage of monomeric bonded alkylsilanes, combined with an exhaustive endcapping, results in a surface with lowest silanol activity. This allows the tailing-free elution of polar compounds such as basic drugs. NUCLEODUR® C₁₈ ec is available in 9 different particle sizes (3, 5, 7, 10, 12, 16, 20, 30 and 50 µm) which cover the whole range from high speed analytical HPLC up to medium and low pressure prep LC. NUCLEODUR® C₁₈ ec is also an ideal tool for scale-up purposes.

Loading capacity

Loading capacity, probably the most important feature for preparative LC applications, is determined by pore size, pore volume and surface area of the packing. However, it can also be influenced by the molecular weight of the analytes. In the figure below the mass loading curve for acetophenone and butyrophenone on a NUCLEODUR® 100-20 C₁₈ ec column describes the correlation between the increase of column loading and the decrease of separation efficiency.

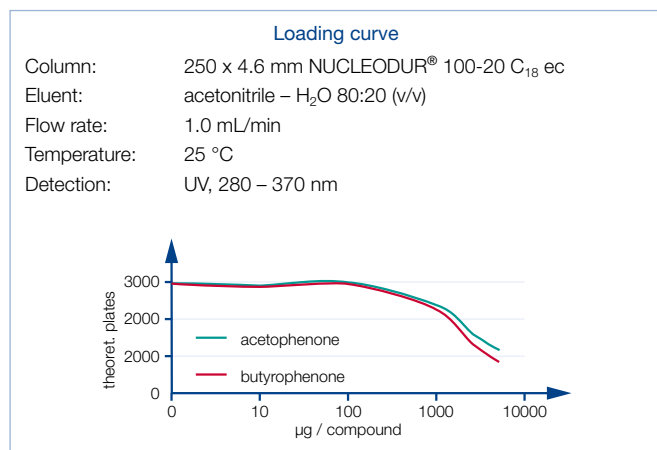

pH stability of NUCLEODUR® C₁₈ ec

Separation of theophylline and caffeine at pH 10

Column: 30 x 3 mm NUCLEODUR® 100-5 C₁₈ ec
 Eluent: methanol – aq. NH₃ (20:80, v/v), pH 10
 Flow rate: 0.5 mL/min
 Temperature: 25 °C
 Detection: UV, 254 nm

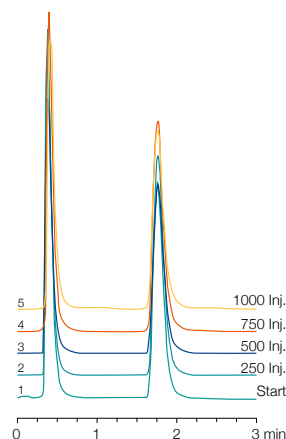

Separation of uracil, veratrol, toluene and ethylbenzene at pH 1.5

Column: 30 x 3 mm NUCLEODUR® 100-5 C₁₈ ec
 Eluent: acetonitrile – H₂O (65:35, v/v), TFA, pH 1.5
 Flow rate: 1.0 mL/min
 Temperature: 25 °C
 Detection: UV, 254 nm

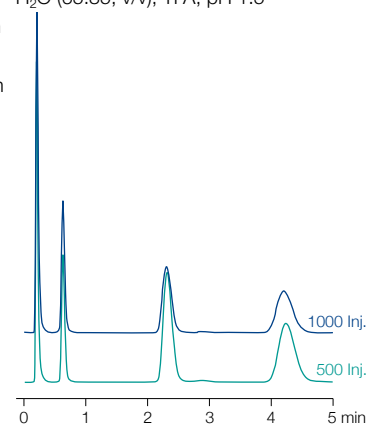



Ordering information

Eluent in column acetonitrile – water

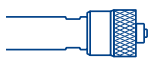
ID	Length →						
	50 mm	75 mm	100 mm	125 mm	150 mm	250 mm	
NUCLEODUR® 100-5 C₁₈ ec octadecyl phase, particle size 5 µm, 17.5 % C							
Analytical EC columns							
	2 mm	760004.20		760013.20	760001.20	760008.20	760002.20
	3 mm	760004.30		760013.30	760001.30	760008.30	760002.30
	4 mm	760004.40		760013.40	760001.40	760008.40	760002.40
	4.6 mm	760004.46	760035.46	760013.46	760001.46	760008.46	760002.46
EC guard columns*			4 x 2 mm: 761932.20		4 x 3 mm: 761932.30		
Preparative VarioPrep columns							
	10 mm	762003.100			762029.100		762022.100
	21 mm	762003.210			762029.210		762022.210
	32 mm						762022.320
	40 mm					762027.400	762022.400
VP guard columns**			10 x 8 mm: 762090.80		10 x 16 mm: 762090.160		
			15 x 32 mm: 762311.320		15 x 50 mm: 762311.500		



NUCLEODUR® 100-10 C₁₈ ec

octadecyl phase, particle size 10 µm, 17.5 % C

Preparative VarioPrep columns							
	10 mm	762011.100			762302.100		762010.100
	21 mm	762011.210			762302.210		762010.210
	32 mm						762010.320
	40 mm					762303.400	762010.400
	50 mm						762010.500
VP guard columns**			10 x 8 mm: 762090.80		10 x 16 mm: 762090.160		
			15 x 32 mm: 762311.320		15 x 50 mm: 762311.500		

Ordering information

Eluent in column acetonitrile – water

ID	Length →						
	50 mm	75 mm	100 mm	125 mm	150 mm	250 mm	
NUCLEODUR® 100-3 C₈ ec octyl phase, particle size 3 µm, 10.5 % C							
Analytical EC columns							
	2 mm	760063.20		760059.20	760060.20		760062.20
	3 mm	760063.30		760059.30	760060.30		760062.30
	4 mm	760063.40		760059.40	760060.40		760062.40
	4.6 mm	760063.46	760064.46	760059.46	760060.46	760061.46	760062.46
EC guard columns*			4 x 2 mm: 761936.20		4 x 3 mm: 761936.30		
NUCLEODUR® 100-5 C₈ ec octyl phase, particle size 5 µm, 10.5 % C							
Analytical EC columns							
	2 mm	760700.20		760704.20	760701.20		760703.20
	3 mm	760700.30		760704.30	760701.30		760703.30
	4 mm	760700.40		760704.40	760701.40		760703.40
	4.6 mm	760700.46	760706.46	760704.46	760701.46	760702.46	760703.46
EC guard columns*			4 x 2 mm: 761937.20		4 x 3 mm: 761937.30		
Preparative VarioPrep columns							
	10 mm	762072.100			762061.100		762062.100
	21 mm	762072.210			762061.210		762062.210
	32 mm						762062.320
	40 mm					762079.400	762062.400
VP guard columns**			10 x 8 mm: 762092.80		10 x 16 mm: 762092.160		15 x 32 mm: 762321.320

EC and VarioPrep columns in packs of 1, guard columns see previous NUCLEODUR® phases.

Guard column systems see previous NUCLEODUR® phases. For details of our column systems see page 250.

NUCLEODUR® C₁₈ ec bulk material with 10–50 µm for self-packing of preparative columns see page 256.

The ordering information for C₁₈ and C₄ modified 300 Å NUCLEODUR® widepore materials for the separation of biopolymers can be found in the chapter "HPLC column for biochemical separations" (see page 241).

* and ** for corresponding guard column systems see page 180.

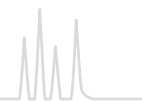

NUCLEODUR® HILIC zwitterionic phase

★ Key feature

- Ideal for reproducible and stable chromatography of highly polar analytes
- Suitable for analytical and preparative applications
- Very short column conditioning period

🔧 Technical data

- Ammonium - sulfonic acid modified silica; pore size 110 Å; particle sizes 1.8, 3 and 5 µm; carbon content 7 %; pH stability 2–8.5

✓ Recommended application

- Hydrophilic compounds such as organic polar acids and bases, polar natural compounds, nucleosides, oligonucleotides, amino acids, peptides, water soluble vitamins

Hydrophilic interaction chromatography

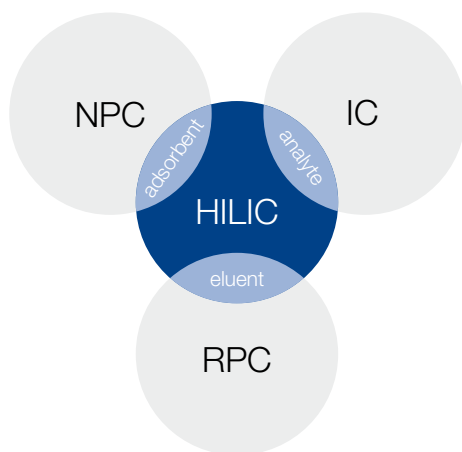

Especially for polar compounds reversed phase HPLC – the most common analytical method – is often limited. Here, hydrophilic stationary phases provide an additional tool for the separation of polar analytes in HPLC.

The expression HILIC (Hydrophilic Interaction Chromatography) was firstly published by Andrew Alpert in 1990 – since then it took quite some efforts to develop robust and reproducible hydrophilic HPLC phases for HILIC chromatography [7].

HILIC combines the characteristics of the 3 major methods in liquid chromatography – reversed phase (RPC), normal phase (NPC) and ion chromatography (IC):

- Stationary phases (adsorbents) are mostly polar modifications of silica or polymers (SiOH, NH₂, Diol, (zwitter) ions, ...) – like in NPC.
- Mobile phases (eluent) are mixtures of aqueous buffer systems and organic modifier like acetonitrile or methanol - like in RPC.
- Fields of application include quite polar compounds as well as organic and inorganic ions – like in IC.

Summarized: “HILIC is NP chromatography of polar and ionic compounds under RP conditions.”

NUCLEODUR® HILIC is a special zwitterionic modified stationary phase based on ultra spherical NUCLEODUR® particles. The betaine character of the ammoniumsulfonic acid ligands results in total charge equalization and in an overall neutrally charged but highly polar surface

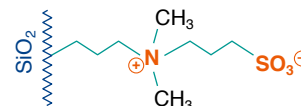

Retention characteristic

Commonly HILIC is described as partition chromatography or liquid-liquid extraction system between mobile and stationary phases. Versus a water-poor mobile phase a water-rich layer on the surface of the polar stationary phase is formed. Thus, a distribution of the analytes between these two layers will occur. Furthermore HILIC includes weak electrostatic mechanisms as well as hydrogen donor interactions between neutral polar molecules under high organic elution conditions. This distinguishes HILIC from ion exchange chromatography - main principle for HILIC separation is based on compound's polarity and degree of solvation.

Separation of uracil and naphthalene

MN Appl. Nos. 122911 / 122912

Columns: A) 125 x 4 mm NUCLEODUR® C₁₈ Pyramid, 3 µm
B) 125 x 4 mm NUCLEODUR® HILIC, 3 µm
Eluent: acetonitrile – water (90:10, v/v)
Flow rate: 1.0 mL/min, temperature 25 °C
Detection: UV, 254 nm

Peaks:
1. Uracil
2. Naphthalene

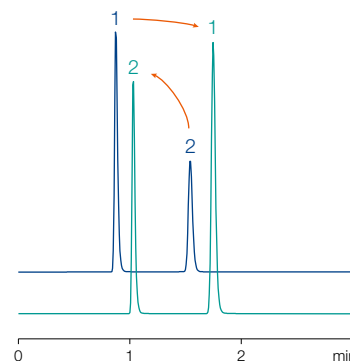

More polar compounds will have stronger interaction with the stationary aqueous layer than less polar compounds – resulting in a stronger retention. Nonpolar compounds exhibit faster elution profiles due to minor hydrophobic interactions. In the separation of uracil and naphthalene the elution order is quite often inverse on HILIC columns compared to RP columns.



Stability features

Due to an advanced and unique surface modification procedure (pat. pend.) NUCLEODUR[®] HILIC columns provide short equilibration times – after just 20 min equilibration already the 2nd injection shows stable and reproducible results.

Beyond this, NUCLEODUR[®] HILIC columns are characterized by an outstanding column life time - even after nearly 800 runs the columns show no loss of pristine performance - peak shape and retention are still immaculate. Due to its high loading capacity NUCLEODUR[®] HILIC is absolutely suitable for preparative and semi-preparative applications.

Overall NUCLEODUR[®] HILIC provides excellent chromatographic features and is hereby the perfect choice for separation of polar or charged compounds.

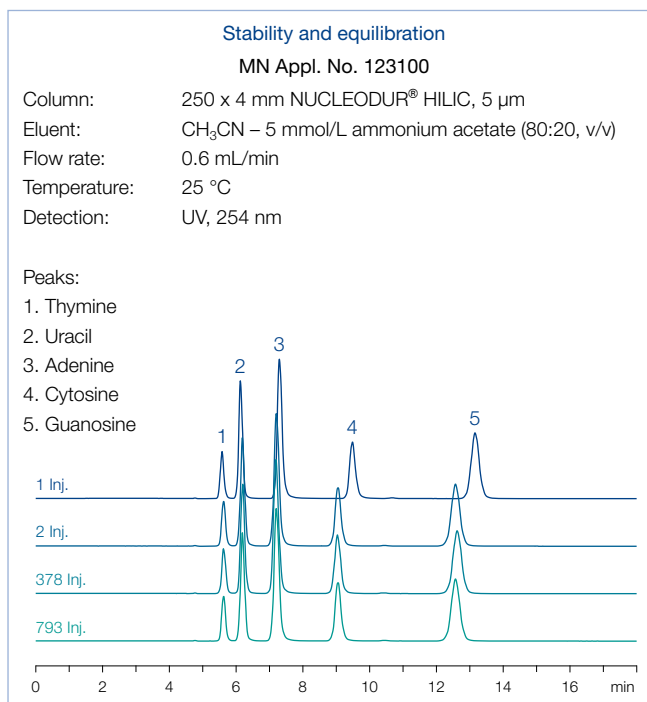

Ordering information

Eluent in column acetonitrile – water (80:20, v/v)

ID	Length → 30 mm	50 mm	75 mm	100 mm	125 mm	150 mm	250 mm
----	-------------------	-------	-------	--------	--------	--------	--------

NUCLEODUR[®] HILIC, 1.8 µm particle size 1.8 µm · UHPLC

Analytical EC columns

	2 mm	760521.20	760523.20	760525.20	760526.20		760528.20
	3 mm	760521.30	760523.30		760526.30		
	4 mm	760521.40	760523.40		760526.40		
	4.6 mm	760521.46	760523.46		760526.46		

EC guard columns*

4 x 2 mm: 761960.20 4 x 3 mm: 761960.30

NUCLEODUR[®] HILIC, 3 µm particle size 3 µm

Analytical EC columns

	2 mm		760532.20		760534.20	760531.20	760533.20	760530.20
	3 mm		760532.30		760534.30	760531.30	760533.30	760530.30
	4 mm		760532.40		760534.40	760531.40	760533.40	760530.40
	4.6 mm		760532.46		760534.46	760531.46	760533.46	760530.46

EC guard columns*

4 x 2 mm: 761961.20 4 x 3 mm: 761961.30

NUCLEODUR[®] HILIC, 5 µm particle size 5 µm

Analytical EC columns

	2 mm		760552.20		760554.20	760551.20	760553.20	760550.20
	3 mm		760552.30		760554.30	760551.30	760553.30	760550.30
	4 mm		760552.40		760554.40	760551.40	760553.40	760550.40
	4.6 mm		760552.46		760554.46	760551.46	760553.46	760550.46

EC guard columns*

4 x 2 mm: 761962.20 4 x 3 mm: 761962.30

Guard column system

Guard columns for EC columns with ID		2 mm	3 mm	4 mm	4.6 mm	Guard column holder
* Column Protection System (pack of)	EC	4/2 (3)	4/3 (3)	4/3 (3)	4/3 (3)	718966

For details of our column systems see page 250.



NUCLEODUR[®] CN / CN-RP cyano-modified high purity silica phase · USP L10

★ Key feature

- High retention capacity especially for very polar and unsaturated compounds
- Multi-mode column (RP and NP) widens scope of selectivity
- Stable against hydrolysis at low pH (working range pH 1–8)

🔧 Technical data

- Cyanopropyl-modified high purity silica; pore size 110 Å; particle sizes 3 µm and 5 µm; carbon content 7 %; special endcapping
- High reproducibility from lot to lot; different retention characteristics in comparison to C₈ and C₁₈

✓ Recommended application

- Tricyclic antidepressants, steroids, organic acids

Alternative bonded-phase functionality

In reversed phase HPLC it is fairly common to start with C₁₈ or C₈ columns, if new methods have to be developed. However, superior polarity and selectivity properties often required for more sophisticated separations, are not always sufficiently provided by classical RP phases, which are usually characterized by a hydrophobic layer of monomeric or polymeric bonded alkylsilanes.

One approach to improve the resolution of compounds poorly separated on nonpolar stationary phases, is to change bonded-phase functionality.

The fully endcapped and highly reproducible NUCLEODUR[®] 100-5 CN-RP phase has cyanopropyl groups on the surface able to generate a clearly recognizable different retention behavior compared to purely alkyl-functionalized surface modifications (see figure below).

The polarity of NUCLEODUR[®] 100-5 CN-RP can be classified as intermediate based on multiple retention mechanisms such as dipole-dipole, π-π, and also hydrophobic interactions [8]. Therefore, this phase shows a distinct selectivity for polar organic compounds as well as for molecules containing π electron systems (e.g., analytes with double bonds, tricyclic antidepressants) [9].

Short-chain bonded phases are sometimes suspected of revealing shortcomings in stability towards hydrolysis at low pH [10]. Application 119350 shows that even after 100 sample injections and four weeks storage at pH 1 (blue curve), neither a considerable shift in retention, nor a visible change in peak symmetry could be noticed (green curve = new column)

Separation of cold medicine ingredients on two different NUCLEODUR[®] phases

MN Appl. No. 119340

Columns: 250 x 4 mm NUCLEODUR[®] 100-5 C₁₈ ec
250 x 4 mm NUCLEODUR[®] 100-5 CN-RP
Eluent: acetonitrile – 100 mmol/L sodium citrate pH 2.5 (15:85, v/v)
Flow rate: 1.0 mL/min, temperature 25 °C
Detection: UV, 254 nm, injection 10 µL

Peaks:

1. Maleic acid
2. Norephedrine
3. Ephedrine
4. Acetaminophen
5. Chlorpheniramine
6. Brompheniramine

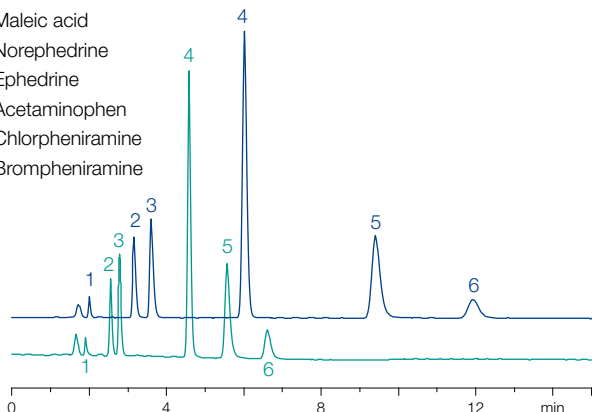

Stability of NUCLEODUR[®] CN-RP at pH 1

MN Appl. No. 119350

Columns: 125 x 4 mm NUCLEODUR[®] 100-5 CN-RP
Eluent: acetonitrile – water, 2 % TFA pH 1 (50:50, v/v)
Flow rate: 1.0 mL/min
Temperature: 25 °C
Detection: UV, 254 nm
Injection: 5 µL

Peaks:

1. Benzamide
2. Dimethyl phthalate
3. Phenetole
4. o-Xylene
5. Biphenyl

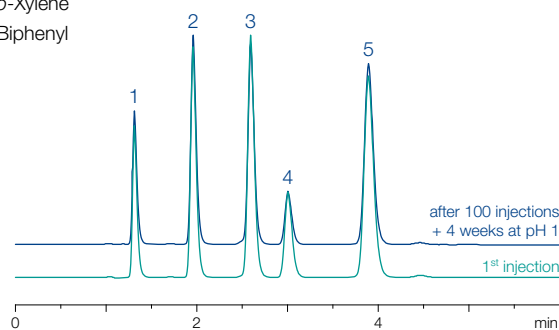



Multi-mode columns

Due to its polarity the cyano phase can also be run in normal phase mode. NUCLEODUR® CN columns for NP applications are shipped in *n*-heptane. The change in selectivity and order of elution for a mixture of various steroids in NP and RP mode is

displayed below. The high coverage combined with a thorough endcapping makes NUCLEODUR® 100-5 CN-RP suitable for separation of ionizable compounds such as basic drugs.

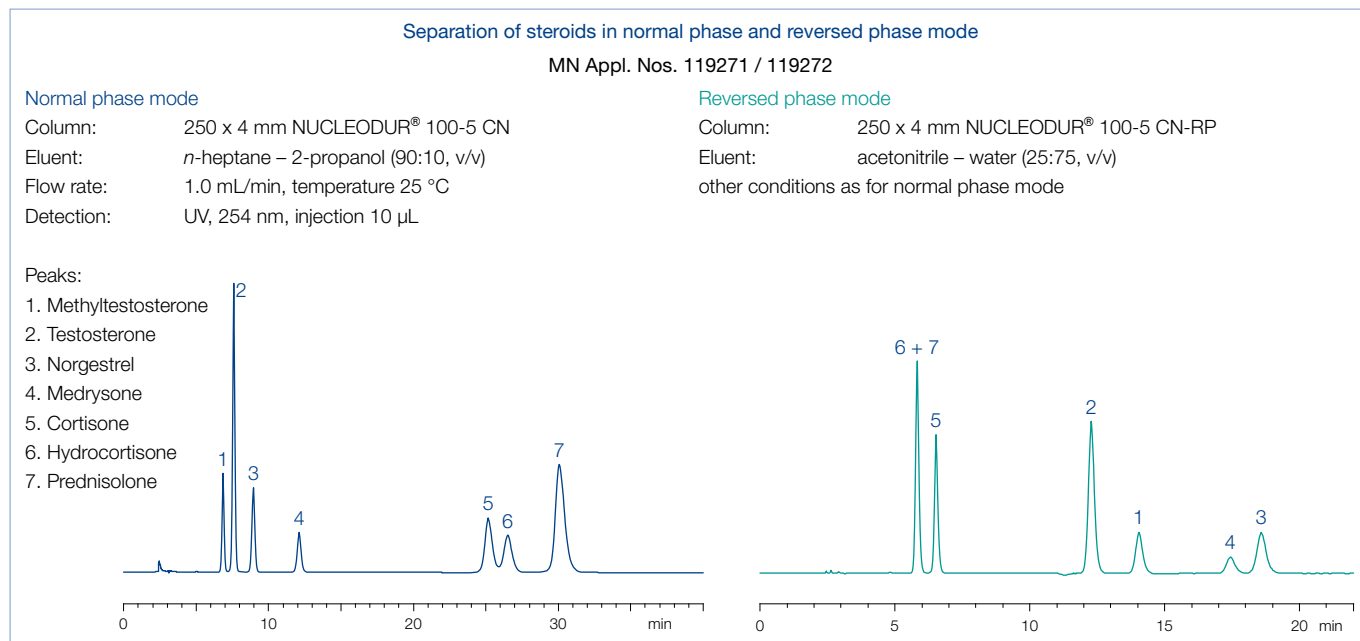

Ordering information

ID	Length →			
	50 mm	125 mm	150 mm	250 mm
NUCLEODUR® 100-3 CN-RP particle size 3 µm; eluent in column acetonitrile – water				
Analytical EC columns				
	2 mm	760159.20	760157.20	
	3 mm		760157.30	
	4 mm			760156.40
	4.6 mm			760156.46
EC guard columns*	4 x 2 mm: 761941.20		4 x 3 mm: 761941.30	
NUCLEODUR® 100-5 CN-RP particle size 5 µm; eluent in column acetonitrile – water				
Analytical EC columns				
	4 mm	760153.40		760152.40
	4.6 mm	760153.46	760154.46	760152.46
EC guard columns*	4 x 3 mm: 761944.30			
NUCLEODUR® 100-5 CN particle size 5 µm; eluent in column <i>n</i> -heptane				
Analytical EC columns				
	4 mm	760151.40	760149.40	760150.40
	4.6 mm	760151.46	760149.46	760150.46
EC guard columns*	4 x 3 mm: 761943.30			

EC columns in packs of 1, guard columns in packs of 3.

Guard column system

Guard columns for EC columns with ID	2 mm	3 mm	4 mm	4.6 mm	Guard column holder
* Column Protection System (pack of)	EC 4/2 (3)	4/3 (3)	4/3 (3)	4/3 (3)	718966

For details of our column systems see page 250.

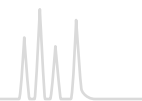

NUCLEODUR[®] NH₂ / NH₂-RP amino-modified high purity silica · USP L8

★ Key feature

- Multi-mode columns (for RP, NP and IC)
- Stable against hydrolysis at low pH (working range pH 2–8), 100 % stable in water; suitable for LC/MS
- Widens scope of analytical HPLC into the polar range

🔧 Technical data

- Aminopropyl modified high purity silica; pore size 110 Å; particle sizes 3, 5 and 7 µm; carbon content 2.5 %; not endcapped

✓ Recommended application

- Polar compounds under RP conditions (sugars, DNA bases), hydrocarbons under NP conditions

- Normal phase chromatography (NP) with hexane, dichloromethane or 2-propanol as mobile phase for polar compounds such as substituted anilines, esters, chlorinated pesticides
- Reversed phase chromatography (RP) of polar compounds in aqueous-organic eluent systems
- Ion exchange chromatography of anions and organic acids using conventional buffers and organic modifiers

Some compounds, especially polar substances, cannot be sufficiently resolved on C₁₈ phases. Polar-modified silica phases offer alternative selectivities thus expanding the spectrum of analytical HPLC into the polar range.

Multi-mode columns

Besides cyano modifications, amino modifications belong to the most frequently used polar silica phases – both feature the important advantage, that they can be run in the RP mode using aqueous-organic eluent mixtures as well as in the NP mode, e.g., with hexane as mobile phase.

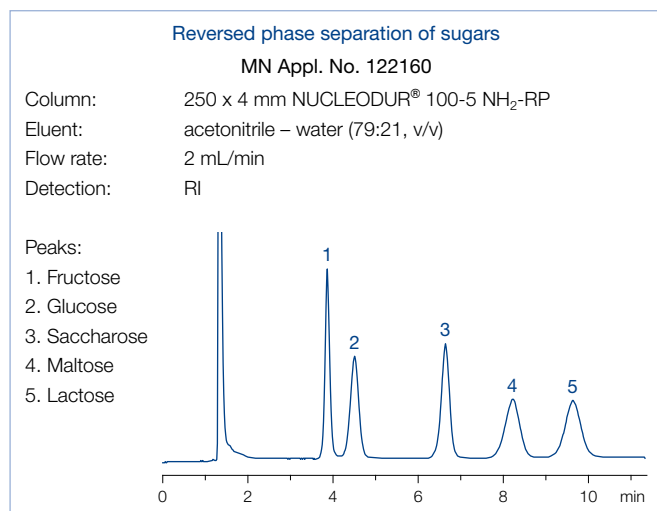

NUCLEODUR[®] NH₂, too, belongs to the so-called multimode columns. It can be used for RP chromatography of polar compounds such as sugars in aqueous-organic eluent systems, for NP chromatography of substituted aromatics or chlorinated pesticides with organic mobile phases such as hexane, dichloromethane or 2-propanol, but also for ion exchange chromatography of anions and organic acids using conventional buffers and organic modifiers.

Main field of application of NUCLEODUR[®] NH₂ is the separation of simple and complex sugars, sugar alcohols and other hydroxy compounds under RP conditions as well as hydrocarbons under NP conditions.

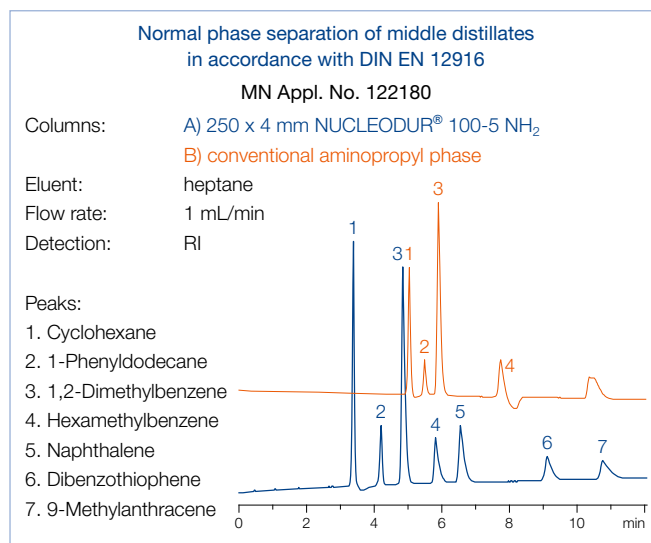

Due to the special method of surface modification NUCLEODUR[®] NH₂ features a pronounced stability at higher as well as at lower pH values. The following figure shows, that even after several days of exposure of the column material at pH 1.75 good separation efficiency and peak symmetry are maintained. The resulting high column life allows cost reduction due to lower column consumption.

This example shows the enhanced pH stability of NUCLEODUR[®] NH₂ and the outstanding suitability for the separation of total herbicides (AMPA, glyphosate, glufonate, ...) - see application 122190 in our online data base at www.mn-net.com/apps.



Hydrolytical resistance of NUCLEODUR® NH₂-RP

Column: 250 x 4 mm NUCLEODUR® 100-5 NH₂-RP
 Eluent: acetonitrile – 50 mmol/L KH₂PO₄, pH 1.75 (50:50, v/v)
 Flow rate: 0.6 mL/min
 Detection: UV, 254 nm

Peaks:
 1. Aminomethylphosphonic acid (AMPA)

after 3872 min
 1st injection

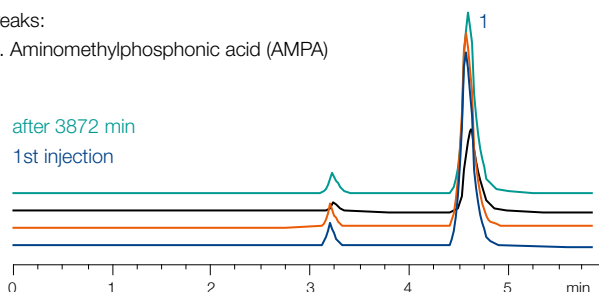

Separation of DNA bases

MN Appl. No. 122170

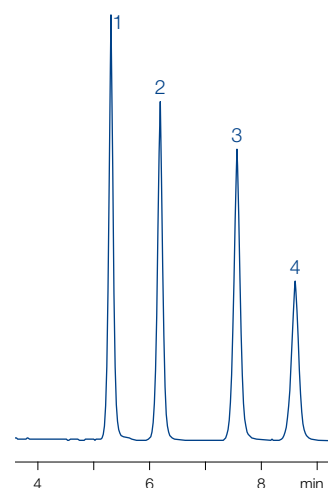

Column: 250 x 4 mm
 NUCLEODUR®
 100-5 NH₂-RP
 Eluent: acetonitrile – water (80:20, v/v)
 Flow rate: 0.6 mL/min
 Temperature: 35 °C
 Pressure: 30 bar
 Detection: UV, 254 nm

Peaks:
 1. Thymine
 2. Uracil
 3. Cytosine
 4. Adenine



Based on superspherical NUCLEODUR® this phase features a high pressure stability, which makes it the perfect choice for preparative separations as well as for LC/MS. Additionally, the high batch-to-batch reproducibility of NUCLEODUR® NH₂ enables reliable analyses especially for routine work.

Ordering information

ID	Length →			
	100 mm	125 mm	150 mm	250 mm
NUCLEODUR® 100-3 NH₂-RP particle size 3 µm; eluent in column acetonitrile – water				
Analytical EC columns				
	2 mm	760740.20	760741.20	
	4.6 mm			760742.46 760739.46
EC guard columns*		4 x 2 mm: 761951.20	4 x 3 mm: 761951.30	
NUCLEODUR® 100-5 NH₂-RP particle size 5 µm; eluent in column acetonitrile – water				
Analytical EC columns				
	2 mm		760730.20	760732.20
	3 mm		760730.30	760732.30
	4 mm		760730.40	760732.40
	4.6 mm		760730.46	760731.46 760732.46
EC guard columns*		4 x 2 mm: 761953.20	4 x 3 mm: 761953.30	
NUCLEODUR® 100-5 NH₂ particle size 5 µm; eluent in column <i>n</i> -heptane				
Analytical EC columns				
	4 mm		760720.40	760722.40
	4.6 mm		760720.46	760721.46 760722.46
EC guard columns*			4 x 3 mm: 761952.30	

EC columns in packs of 1, guard columns in packs of 3.

Guard column system

Guard columns for EC columns with ID	2 mm	3 mm	4 mm	4.6 mm	Guard column holder
* Column Protection System (pack of)	EC 4/2 (3)	4/3 (3)	4/3 (3)	4/3 (3)	718966

For details of our column systems see page 250.



NUCLEODUR[®] SiOH unmodified silica for normal phase · USP L3

★ Key feature

- Totally spherical high purity silica
- Pressure stable up to 600 bar
- Suitable for analytical and preparative separation of polar and midpolar compounds

🔧 Technical data



- Unmodified high purity silica; pore size 110 Å; particle sizes 3 to 50 µm; pore volume 0.9 mL/g; surface area (BET) 340 m²/g; pH stability 2–8; metal content < 10 ppm (see page 150)

✓ Recommended application

- Polar and midpolar compounds under normal phase conditions

Ordering information

Eluent in column *n*-heptane

ID	Length →			
	50 mm	125 mm	150 mm	250 mm
NUCLEODUR[®] 100-3 particle size 3 µm				
Analytical EC columns				
	4.6 mm	760170.46	760172.46	760173.46
EC guard columns*	4 x 3 mm: 761966.30			
NUCLEODUR[®] 100-5 particle size 5 µm				
Analytical EC columns				
	4 mm			760007.40
	4.6 mm	760023.46	760012.46	760007.46
EC guard columns*	4 x 3 mm: 761967.30			
Preparative VarioPrep columns				
	10 mm	762077.100	762078.100	762007.100
	21 mm	762077.210	762078.210	762007.210
	40 mm		762075.400	762007.400
VP guard columns*	10 x 8 mm: 762094.80		10 x 16 mm: 762094.160	
	15 x 32 mm: 762330.320			

EC and VarioPrep columns in packs of 1, guard columns see below.

Guard column systems

Guard columns for EC columns with ID		2 mm	3 mm	4 mm	4.6 mm	Guard column holder
* Column Protection System (pack of)	EC	4/2 (3)	4/3 (3)	4/3 (3)	4/3 (3)	718966
Guard columns for VarioPrep columns with ID		8, 10 mm	16, 21 mm	32, 40 mm	≥ 50 mm	
** VP guard columns (pack of)	VP	10/8 (2)	10/16 (2)	15/32 (1)	15/50 (1)	
VP guard column holder		718251	718256	718253	718255	

For details of our column systems see page 250.

Unmodified NUCLEODUR[®] bulk material in 10–50 µm for self-packing of preparative columns see page 256.



MACHEREY-NAGEL

your partner in HPLC · also online

Besides to this catalog our website provides useful information

- Applications
Database without registration, with more than 3000 free chromatography applications for your separation task.
- Instruction manuals
General advises for column care and individual column cleaning are available in the attached instruction manual or online.
- HPLC troubleshooting
Sometimes during chromatographic separation unexpected effects occur. We give advise of possible reasons and how to avoid or remedy these.
- Flyers, brochures, catalogs
Our product information is available online as PDF file at any time.



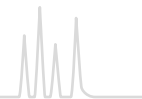

Core-shell technology

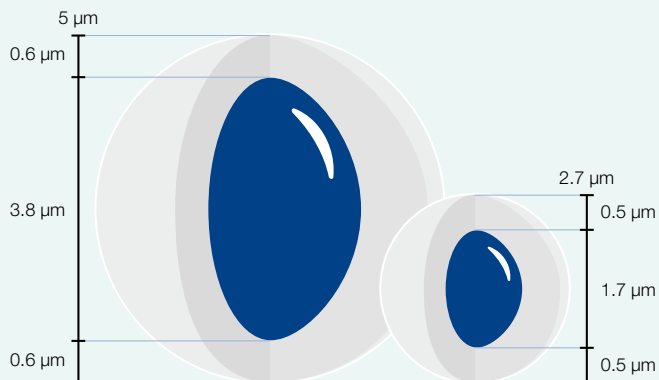

Key feature

- Solid core of silicon dioxide, homogeneous shell of porous silica
- Highest efficiency compared to traditional totally porous materials
- Pore size 90 Å; particle size 2.7 µm (core 1.7 µm) and 5 µm (core 3.8 µm); specific surface 130 (2.7 µm) and 90 (5 µm) m²/g lower back pressure enables use on conventional LC systems
- Pressure stability 600 bar

Demands on HPLC separations are constantly increasing with respect to separation efficiency, detection limits, and the time requirements for each analysis.

Several approaches have been made to achieve fast separations without losing chromatographic performance. HPLC columns packed with particles < 2 µm show very high efficiencies (plates/meter) and allow the use of smaller column sizes with the positive side effect of significant solvent saving. However they generate a high back pressure of the mobile phase during column runs which requires specifically designed equipment.

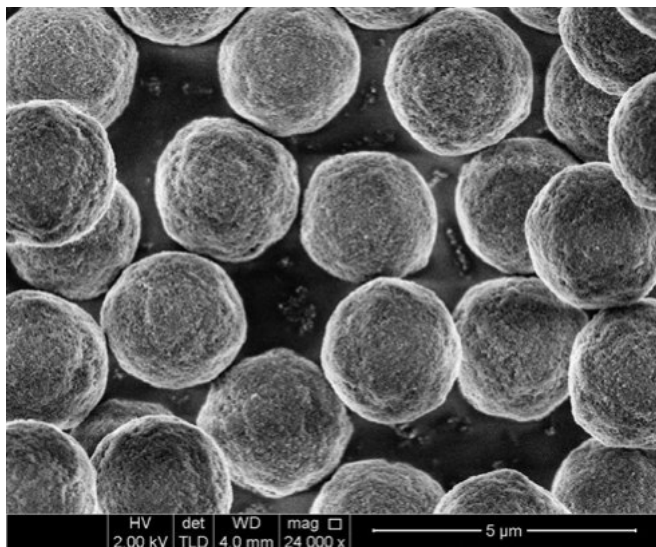

Electron microscopic image of NUCLEOSHELL®

NUCLEOSHELL® silica particles consist of a non-porous solid core of 1.7 µm diameter and a porous outer shell of 0.5 µm thickness. Accordingly the total diameter of the particle is 2.7 µm.

Utilizing a proprietary process of synthesis, NUCLEOSHELL® particles exhibit a distinct narrow particle size distribution (d₉₀/d₁₀ ~ 1.1). Columns packed with NUCLEOSHELL core shell particles feature exceptional separation efficiencies with theoretical plate numbers easily comparable to totally porous sub 2 micron particles.

$$R_s = \frac{\sqrt{N}}{4} \left(\frac{\alpha - 1}{\alpha} \right) \left(\frac{k'_i}{k'_i + 1} \right)$$

R_s = resolution, α = selectivity (separation factor), k'_i = retention
 N = plate number with $N \propto 1/d_p$, d_p = particle diameter

Resolution R_s as function of particle size

MN Appl. No. 125270

Columns: 50 x 4 mm
 NUCLEOSHELL® RP 18, 2.7 µm
 NUCLEODUR® C₁₈ Gravity, 3 µm
 NUCLEODUR® C₁₈ Gravity, 1.8 µm
 Eluent: acetonitrile – water (60:40, v/v)
 Flow rate: 1 mL/min
 Temperature: 25 °C
 Detection: UV, 254 nm

Peaks:
 1. Naphthalene
 2. Ethylbenzene

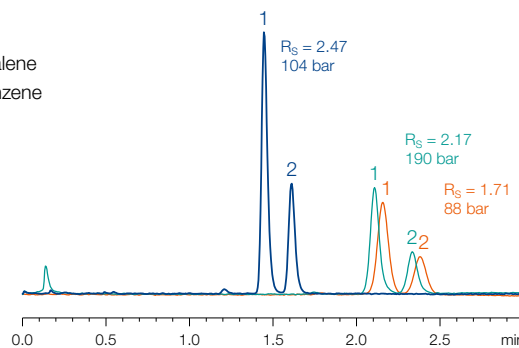



Theoretical column efficiency (optimal conditions)

Silica	d _p [μm]	L [m]	HETP [μm]	Efficiency [plates/m]	L [mm]	N	R _s	Analysis time
NUCLEOSHELL®	2.7	1	4	250 000	100	25 000	112 %	40 %
	5	1	6.5	154 000	150	23 000	115 %	60 %
NUCLEODUR®	1.8	1	4.5	222 222	100	22 000	105 %	40 %
	3	1	7.5	133 333	150	20 000	100 %	60 %
	5	1	12.5	80 000	250	20 000	100 %	100 %

Benefits of core-shell technology

Core-shell particles vs. totally porous silica

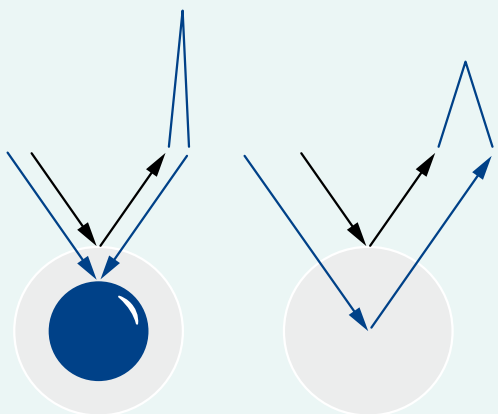

Short diffusion paths

- Fast mass transfer (term C of Van Deemter equation)
- High flow velocity without peak broadening for fast LC

Narrow particle size distribution (d₉₀/d₁₀ ~ 1.1)

- Stable packing

High heat transfer

- Minimized influence of frictional heat
- Efficiency of NUCLEOSHELL® ~ 250 000 m⁻¹ (HETP ~ 4 μm)

With conventional fully porous particles the mass transfer between stationary and mobile phase usually results in peak broadening at higher flow rates (C-term in van Deemter equation). The short diffusion paths in the core-shell particles reduce the

dwelt time of the analyte molecules in the stationary phase, so that even at high flow velocities of the mobile phase, optimal separation results can be obtained.

The van Deemter plots demonstrate how efficiency is affected by flow rate.

In comparison with fully porous silicas, core-shell particles from various manufacturers maintain the efficiency optimum (max. plates/m) over a long range of increasing linear mobile phase velocity.

$$H = A + \frac{B}{u} + C \cdot u$$

A term = eddy-diffusion, B term = longitudinal diffusion coefficient, C term = mass transfer coefficient

Van Deemter curves

MN Appl. No. 125500

Column: 50 x 4.6 mm
 Eluent: CH₃CN – H₂O (70:30, v/v)
 Temperature: 25 °C
 Sample: Acenaphthene

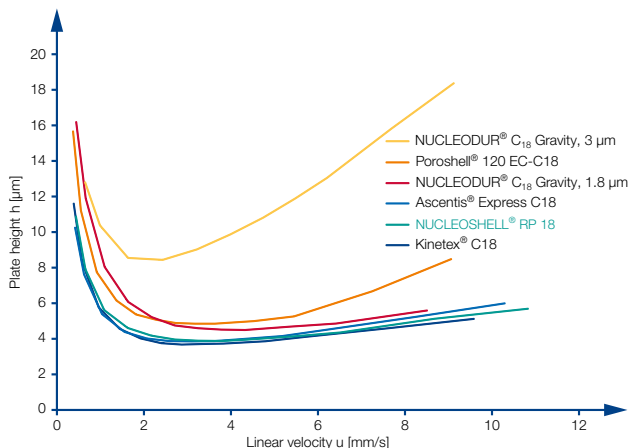



NUCLEOSHELL® core-shell silica for HPLC

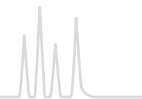

In direct comparison with conventional sub 2 micron phases, NUCLEOSHELL® columns only generate about 60% of the back pressure and can be operated with the majority of conventional HPLC systems. In order to develop the maximum performance of NUCLEOSHELL® columns, we recommend reducing extra column voids by using suitable capillaries (< 0.15 mm inner diameter) and specially adapted detector cells. Moreover detector settings should be optimized by increasing the measuring rate or by decrease of the time constant.

$$\Delta_p = \frac{\Phi \cdot L_C \cdot \eta \cdot u}{d_p^2}$$

Δ_p = pressure drop, Φ = flow resistance (nondimensional), L_C = column length, η = viscosity, u = linear velocity, d_p = particle diameter

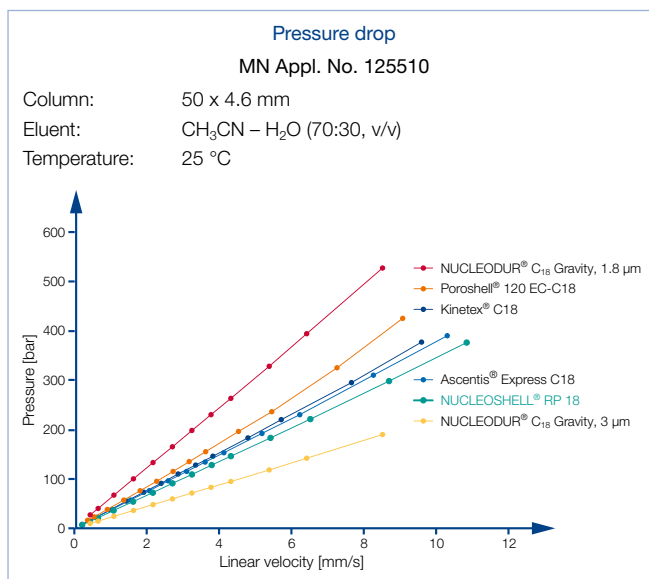

Core-shell particle technology from MACHEREY-NAGEL is an alternate route to gain highest column efficiency and resolution in HPLC at short run time, but with moderate back pressure.

Features of NUCLEOSHELL® particles

A criterion for the long-term stability of the column at pH extremes is the percentage decrease of initial retention and initial plates, respectively.

The following figure shows a column stability test of NUCLEOSHELL® RP 18 at mobile phase levels pH 1 and pH 10 compared with three competing phases.

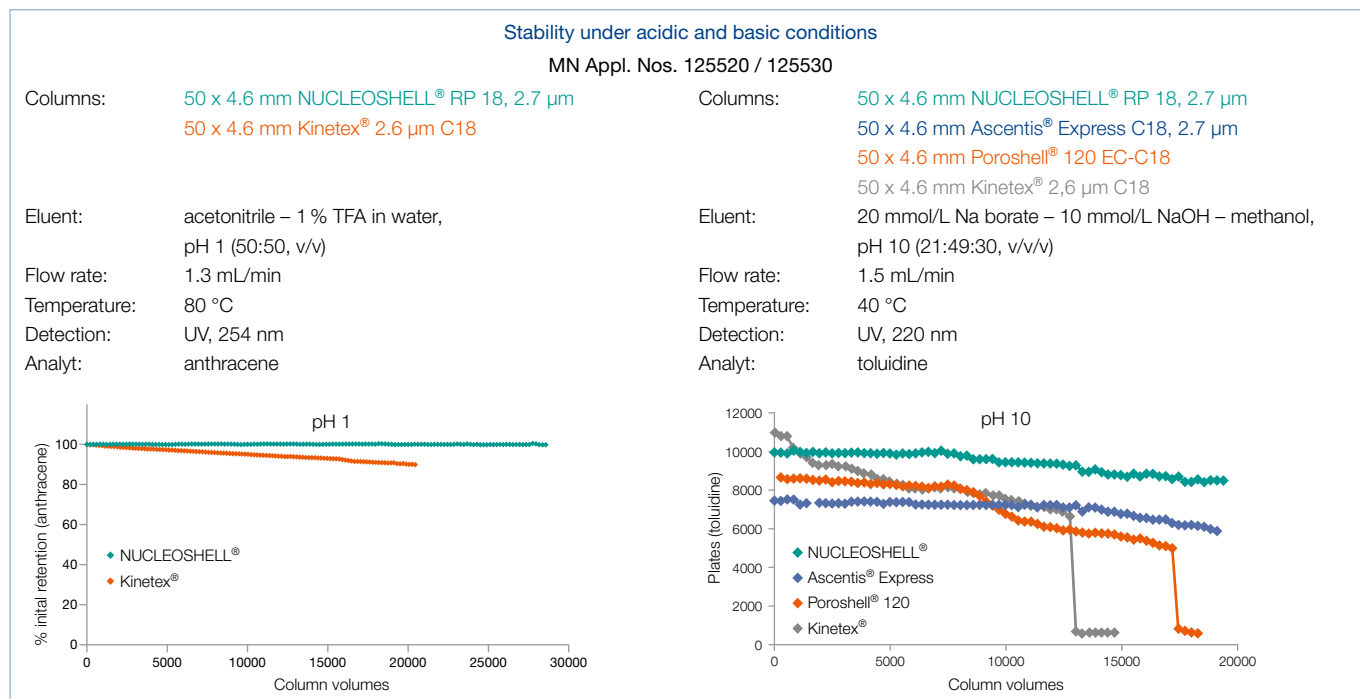



Columns can be operated at elevated temperatures without loss in retention, efficiency or peak symmetry.

Uniformly shaped NUCLEOSHELL® particles combined with optimized bonding technology safeguard tightly packed columns for 100 % reproducible results.

Temperature stability

MN Appl. No. 125400

Stability test:

Column: 50 x 2 mm NUCLEOSHELL® RP 18, 2.7 µm
 Eluent: A) 10 mmol/L ammonium formate – methanol (9:1, v/v) + 120 µL formic acid, ~ pH 4
 B) 10 mmol/L ammonium formate – methanol (1:9, v/v) + 120 µL formic acid, ~ pH 4
 0–100 % B in 7 min
 Flow rate: 0.5 mL/min,
 Temperature: 100 °C
 Detection: UV, 220 nm

Peaks:

1. Phenol
2. Naphthalene

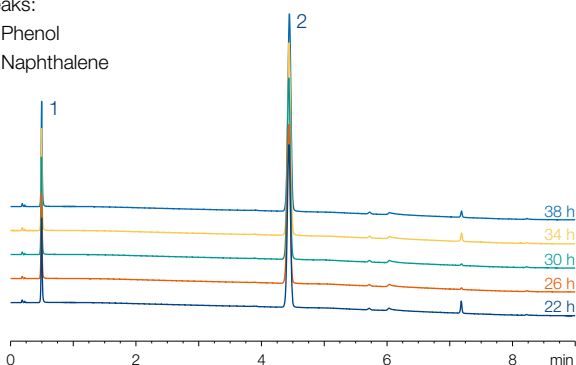

Efficiency test:

Eluent: Acetonitrile – water (60:40, v/v)
 Flow rate: 0.33 mL/min;
 Temperature: 25 °C
 Detection: UV, 254 nm
 Analyte: Anthracene

	HETP [µm]	Asymmetry
Start (t = 0)	5.2	0.98
End (t = 40 h)	5.2	1.01

Batch-to-batch reproducibility

MN Appl. No. 125410

Column: 50 x 4 mm NUCLEOSHELL® RP 18, 2.7 µm
 Eluent: methanol – 25 mmol/L KH₂PO₄, pH 7 (70:30, v/v)
 Flow rate: 1 mL/min
 Temperature: 40 °C
 Detection: UV, 254 nm

Peaks:

1. Uracil
2. Toluene
3. Ethylbenzene
4. Acenaphthene
5. Amitriptyline
6. o-Terphenyl
7. Triphenylene

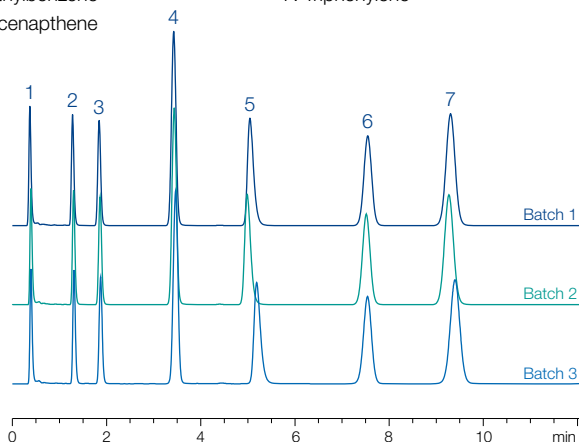

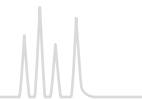

Peak capacity

The peak capacity is a measure for the number of sample analytes that can be separated on HPLC columns per time unit. Narrow peaks increase the peak capacity and thus the efficiency of the analytical column.

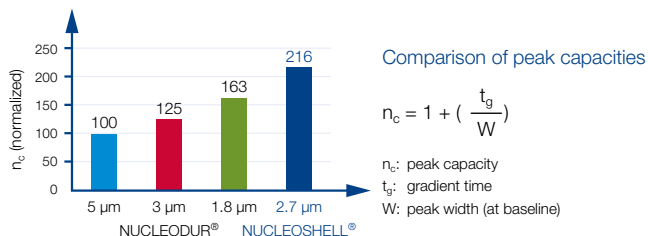

The example shows, that in comparison with totally porous NUCLEODUR® silica (1.8 µm) NUCLEOSHELL® provides 33 % higher peak capacity.

Peak capacity
 MN Appl. No. 125540

Columns: 100 x 4.6 mm each
 NUCLEOSHELL® RP 18, 2.7 µm
 NUCLEODUR® C₁₈ Gravity, 1.8 µm
 NUCLEODUR® C₁₈ Gravity, 3 µm
 NUCLEODUR® C₁₈ Gravity, 5 µm

Eluent: A) acetonitrile, B) water, 40–100 % A in 4 min
 Flow rate: 1.5 mL/min
 Temperature: 25 °C
 Detection: UV, 230 nm

Peaks:
 1. Acetophenone
 2. Benzoin
 3. Propiophenone
 4. Butyrophenone
 5. Benzophenone
 6. Valerophenone

	Max. pressure [bar]	Resolution (4.5)
NUCLEOSHELL®, 2.7 µm	255	5.45
NUCLEODUR®, 1.8 µm	450	4.14
NUCLEODUR®, 3 µm	214	2.97
NUCLEODUR®, 5 µm	142	2.30

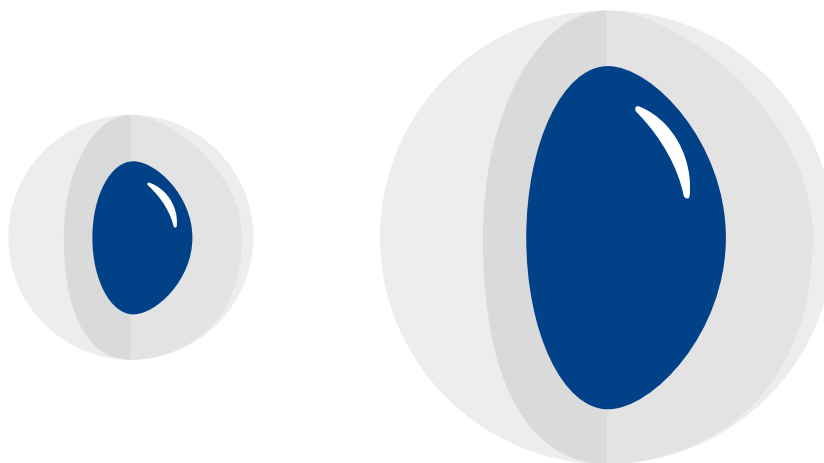



Loading capacity

NUCLEOSHELL® columns allow reliable quantification in a wide analytical detection range. Retention time and peak width at 50 % height remain constant with increasing columns load although core-shell particles are suspected of showing a slightly lower loading capacity compared to fully porous silica materials.

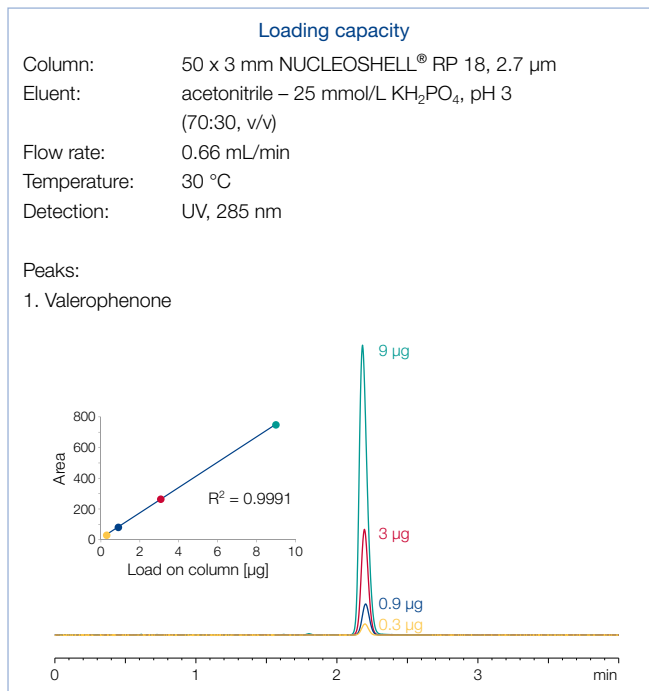
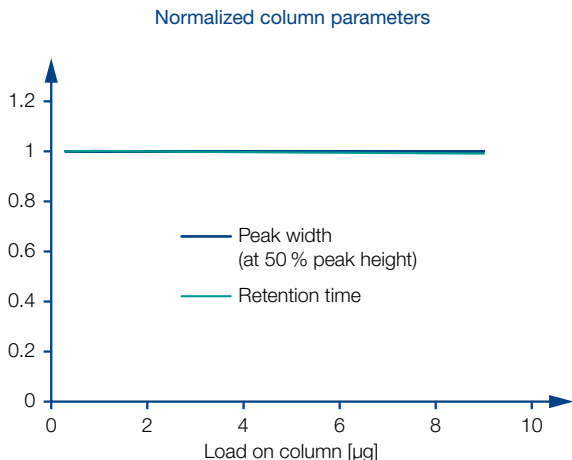

Method transfer of 5 µm particle columns

NUCLEOSHELL® is also available in 5 µm particle size to offer all benefits of core-shell technology to all applications which are bound to particle size.

Separation of cephalosporin antibiotics

MN Appl. No. 126630

Comparison of 5 µm core-shell and totally porous phase

Columns: each 100 x 4.6 mm
 A) NUCLEOSHELL® RP 18plus, 5 µm
 B) NUCLEODUR® Gravity C₁₈, 5 µm

Eluent: methanol – water + 0.1 % formic acid (35:65, v/v)

Flow rate: 1.3 mL/min

Pressure: 182 bar, 219 bar

Temperature: 25 °C

Detection: UV, 254 nm

Injection: 4.0 µL

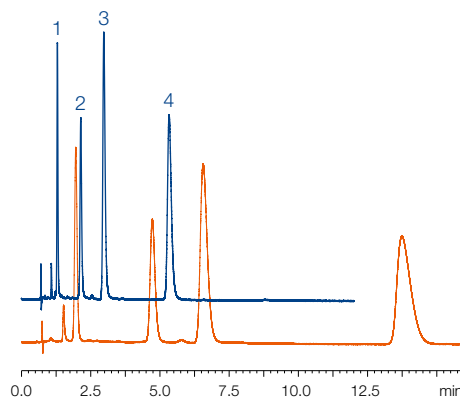

Peaks:	Ret. time [min]		Asymmetry (EP)		Plates (EP)	
	A	B	A	B	A	B
1 Cefotaxime	1.30	1.96	1.19	1.12	6800	2218
2 Cefoxitin	2.14	4.72	1.22	1.20	6599	3471
3 Cefamandole	2.97	6.57	1.24	1.25	6259	3367
4 Cefalotine	5.33	13.73	1.32	1.61	6948	3672



NUCLEOSHELL® phase overview

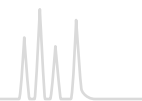

Overview of NUCLEOSHELL® HPLC phases

Phase	Specification	Page	Characteristic*	Stability	Structure
 RP 18	octadecyl, multi-encapping 7.8 % C (2.7 µm particles) 6.1 % C (5 µm particles) USP L1	200	A ●●●●● B ● C ●●●	pH 1–11, suitable for LC/MS	NUCLEOSHELL® (Si-O) ₂ n
 RP 18plus	octadecyl (monomeric), multi-encapping 5.7 % C (2.7 µm particles) 4.4 % C (5 µm particles) USP L1	202	A ●●●●● B ●●●● C -	pH 2–9, suitable for LC/MS	NUCLEOSHELL® (Si-O) ₂ n
 Phenyl-Hexyl	phenylhexyl, multi-encapping 4.5 % C (2.7 µm particles) USP L11	204	A ●● B ●●●● C ●	pH 1–10, suitable for LC/MS	NUCLEOSHELL® (Si-O) ₂ n
 PFP	pentafluorophenyl, multi-encapping ~ 3 % C (2.7 µm particles) USP L43	206	A ●● B ●●●●● C ●●●●●	pH 1–9, suitable for LC/MS	NUCLEOSHELL® (Si-O) ₂ n
 HILIC	zwitterionic ammonium – sulfonic acid 1.3 % C (2.7 µm particles)	208	A ● B ●●●●● C -	pH 2–8.5, suitable for LC/MS	NUCLEOSHELL® (Si-O) ₂ n

* A = ● hydrophobic selectivity, B = ● polar / ionic selectivity, C = ● steric selectivity

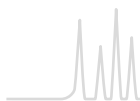

NUCLEOSHELL[®] phase overview

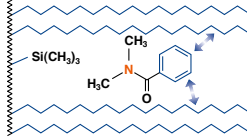
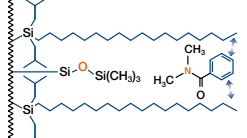
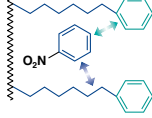
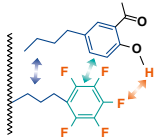
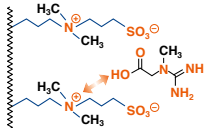

Application	Similar phases**	Interactions · retention mechanism
overall sophisticated analytical separations, e.g., analgesics, anti-inflammatory drugs, antidepressants; herbicides; phytopharmaceuticals; immunosuppressants	Kinetex [®] C18; Cortecs [®] C18; Raptor [®] C18; Accucore [®] C18; Ascentis [®] Express C18	hydrophobic (van der Waals interactions) 
overall sophisticated analytical separations, especially for polar compounds, e.g., pharmaceuticals like antibiotics, water-soluble vitamins, organic acids	Kinetex [®] XB-C18; Bonshell [®] ASB-C18; Raptor [®] ARC-C18;	hydrophobic (van der Waals interactions) 
aromatic and unsaturated compounds, polar compounds like pharmaceuticals, antibiotics	Ascentis [®] Express Phenyl-Hexyl; Kinetex [®] Phenyl-Hexyl; Accucore [®] Phenyl-Hexyl; Ultracore [®] Phenyl-Hexyl; Poroshell [®] Phenyl-Hexyl	π - π and hydrophobic 
aromatic and unsaturated compounds, phenols, halogenated hydrocarbons, isomers, polar compounds like pharmaceuticals, antibiotics	Kinetex [®] PFP; Ascentis [®] Express F5; Accucore [®] PFP	polar (H bond), dipole-dipole, π - π and hydrophobic 
hydrophilic compounds such as organic polar acids and bases, polar natural compounds	–	ionic / hydrophilic and electrostatic 

** phases which provide a similar selectivity based on chemical and physical properties

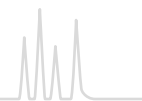

NUCLEOSHELL® RP 18 nonpolar high density phase · USP L1

★ Key feature

- Core-shell technology for fast and efficient HPLC
- Suitable for LC/MS and HPLC at pH extremes (pH 1–11)
- Superior base deactivation, ideal for method development

🔧 Technical data

- Octadecyl modification, multi-end-capped; pore size 90 Å, particle size 2.7 and 5 µm, carbon content 7.8 % for 2.7 µm, 6.1 % for 5 µm; pH stability 1–11; suitable for LC/MS

✓ Recommended application

- Overall sophisticated analytical separations, e.g., analgesics, anti-inflammatory drugs, antidepressants; herbicides; phytopharmaceuticals; immunosuppressants

NUCLEOSHELL® RP 18 is based on core-shell silica. A unique derivatization process generates a homogeneous surface with a high density of bonded silanes. The following thorough endcapping suppresses any unwanted polar interactions between the silica surface and the sample, which makes NUCLEOSHELL® RP 18 particularly suitable for the separation of basic and other

ionizable analytes. The extremely reduced silanol activity of the phase can be demonstrated by applying basic analytes, such as tricyclic antidepressants. The chromatogram below shows a sharp elution profile (superior resolution!) of these highly polar compounds with an excellent asymmetry value for amitriptyline of 1.12.

Tricyclic antidepressants · comparison of selectivity and resolution

MN Appl. No. 124960

Columns: 50 x 4.6 mm each
 NUCLEOSHELL® RP 18, 2.7 µm
 Ascentis® Express C18
 Kinetex® 2.6 µm C18
 Poroshell® 120 EC-C18

Eluent: methanol – acetonitrile – 25 mmol/L KH₂PO₄, pH 7
 (22.5:22.5:55, v/v/v)

Flow rate: 2 mL/min

Pressure: 224 bar, 239 bar, 248 bar, 212 bar

Temperature: 40 °C

Detection: UV, 220 nm

- Peaks:
1. Protriptyline
 2. Desipramine
 3. Maprotiline
 4. Nortriptyline
 5. Doxepin
 6. Imipramine
 7. Amitriptyline
 8. Clomipramine
 9. Trimipramine

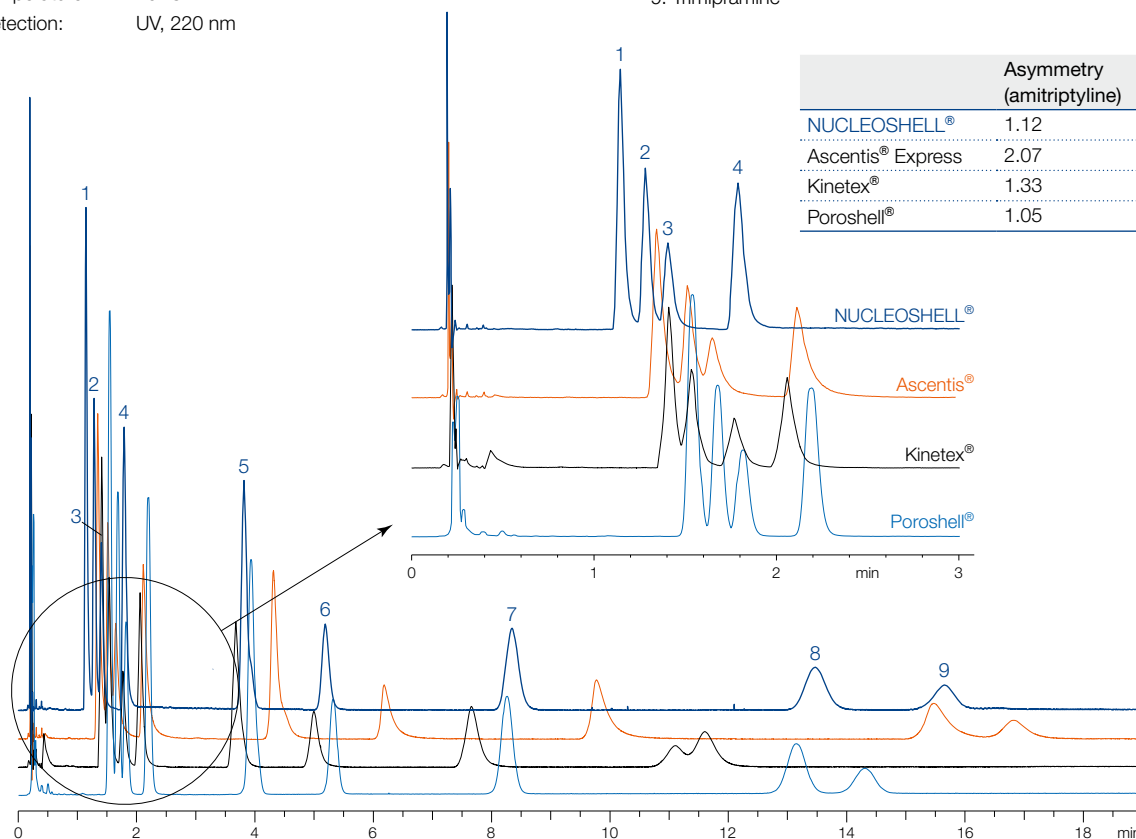

	Asymmetry (amitriptyline)	Resolution (8, 9)
NUCLEOSHELL®	1.12	3.35
Ascentis® Express	2.07	1.91
Kinetex®	1.33	n.a.
Poroshell®	1.05	1.95

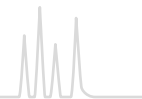

NUCLEOSHELL® RP 18plus C₁₈ phase with polar selectivity · USP L1

★ Key feature

- Based on core-shell particle technology for fast and efficient HPLC
- Hydrophobic C₁₈ phase with distinct polar selectivity, ideal for method development
- Excellent performance under highly aqueous conditions

🔧 Technical data

- Monomeric octadecyl modification, multi-encapped; pore size 90 Å, available particle sizes 2.7 µm and 5 µm, carbon content 5.7 % for 2.7 µm, 4.4 % for 5 µm; pH stability 2–9; suitable for LC/MS

✓ Recommended application

- Overall sophisticated analytical separations, especially for polar compounds, e.g., pharmaceuticals like antibiotics, water-soluble vitamins, organic acids

NUCLEOSHELL® RP 18plus is a C₁₈ modified core-shell silica. Due to a monomeric bonding chemistry this HPLC phase offers hydrophobic characteristics with distinct polar selectivity. A special derivatization process generates a medium density of bonded silanes with reduced steric selectivity compared to NUCLEOSHELL® RP 18.

Bleeding characteristics

MN Appl. No. 126640

Column: 50 x 2 mm NUCLEOSHELL® RP 18plus, 2.7 µm
Eluent: A) 0.1 % formic acid in water
B) 0.1 % formic acid in acetonitrile
95 % A → 5 % A in 4.5 min (0.5 min) → 95 % A in 0.5 min (4.5 min)
Flow rate: 0.5 mL/min
Temperature: 25 °C
Detection: MS

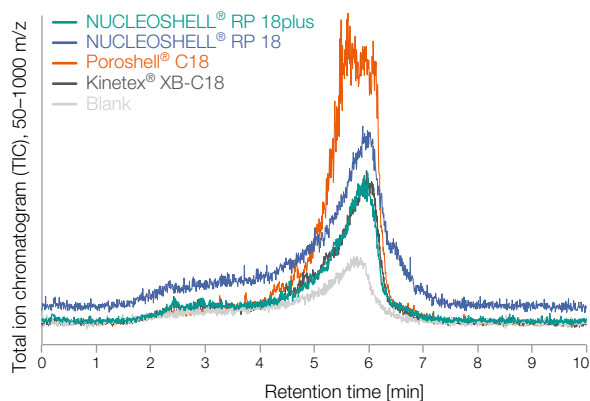

NUCLEOSHELL® RP 18plus combines superbly hydrophobic and polar selectivity – so it is a useful tool for method development in RP chromatography. Good pH stability and low bleeding characteristics make it ideal especially for LC/MS applications.

pH stability of NUCLEOSHELL® RP 18plus

MN Appl. No. 126650

Column: 100 x 4 mm NUCLEOSHELL® RP 18plus, 2.7 µm
Eluent pH 1: 1 % TFA in water - acetonitrile (50:50, v/v)
Eluent pH 9: 50 mmol/L triethylammonium acetate adjusted to pH 9
Flow rate: for pH 1: 0.8 mL/min, for pH 9: 0.56 mL/min
Temperature: for pH 1: 60 °C, for pH 9: 50 °C
Detection: UV, 254 nm
Injection: 1 µL

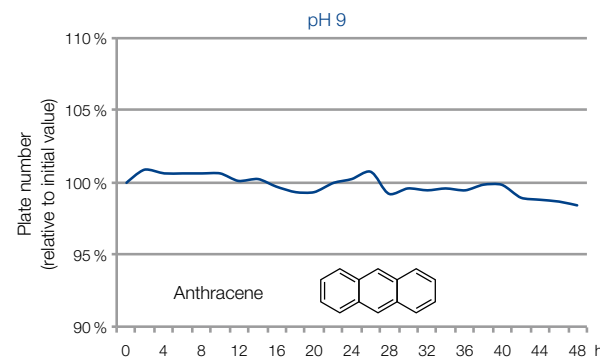
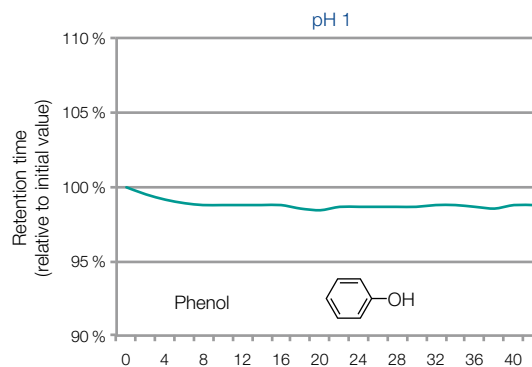

Also a comparison of retention of the glycopeptide antibiotic vancomycin on several octadecyl modified core-shell phases underlines the polar selectivity of NUCLEOSHELL® RP 18plus.



Polar selectivity shown for vancomycin

MN Appl. No. 126660

Columns: 50 x 3 mm each
 NUCLEOSHELL® RP 18plus, 2.7 µm
 NUCLEOSHELL® RP 18, 2.7 µm
 Kinetex® 2.6 µm C18

Eluent: water – methanol – acetonitrile – glacial acetic acid (100:8:2:0.3, v/v/v/v) adjusted to pH 3.2 with sodium hydroxide solution

Flow rate: 0.9 mL/min
 Temperature: 35 °C
 Detection: UV, 240 nm
 Injection: 10 µL

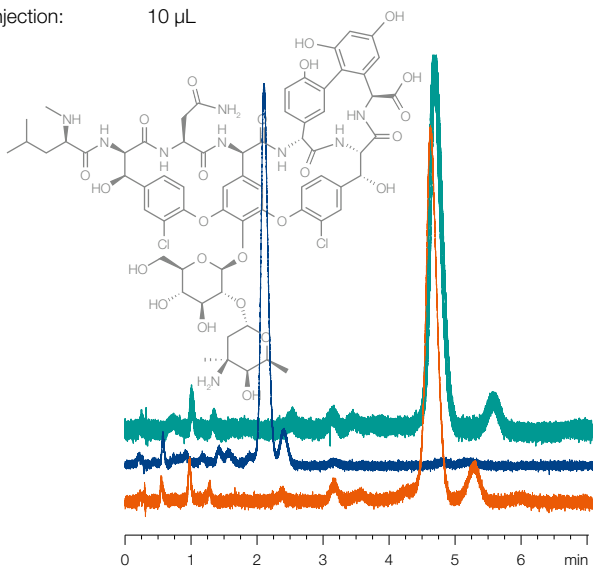

In addition NUCEOSHELL® RP 18plus provides a good stability under highly aqueous conditions. Even by long term usage or storage of the phase phase collapse and loss of retention are hardly observed. The original performance can be regained after a short regeneration procedure.

Phase collapse and regeneration

MN Appl. No. 126670

Column: 100 x 4 mm NUCLEOSHELL® RP 18plus, 2.7 µm
 Eluent: 20 mmol/L KH₂PO₄, pH 2.6
 Flow rate: 0.5 mL/min
 Temperature: 20 °C
 Detection: UV, 215 nm
 Injection: 0.5 µL

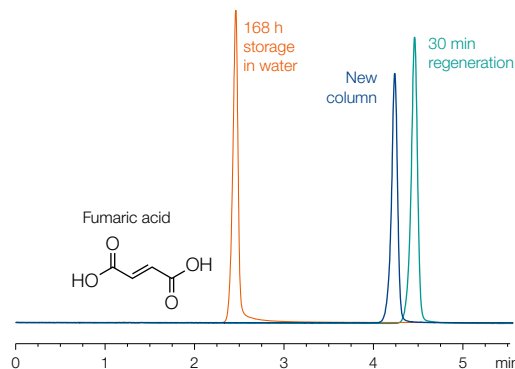

Ordering information

Eluent in column acetonitrile – water

ID	Length → 50 mm	100 mm	150 mm	250 mm	EC guard columns*
----	-------------------	--------	--------	--------	-------------------

NUCLEOSHELL® RP 18plus, 2.7 µm particle size 2.7 µm

Analytical EC columns

	2 mm	763232.20	763234.20	763236.20	763238.20
	3 mm	763232.30	763234.30	763236.30	763238.30
	4 mm	763232.40	763234.40	763236.40	763238.30
	4.6 mm	763232.46	763234.46	763236.46	763238.30

NUCLEOSHELL® RP 18plus, 5 µm particle size 5 µm

Analytical EC columns

	2 mm	763252.20	763254.20	763256.20	763257.20	763258.20
	3 mm	763252.30	763254.30	763256.30	763257.30	763258.30
	4 mm	763252.40	763254.40	763256.40	763257.40	763258.30
	4.6 mm	763252.46	763254.46	763256.46	763257.46	763258.30

EC columns in packs of 1, guard columns in packs of 3.

Guard column system

Guard columns for EC columns with ID		2 mm	3 mm	4 mm	4.6 mm	Guard column holder
* Column Protection System (pack of)	EC	4/2 (3)	4/3 (3)	4/3 (3)	4/3 (3)	718966

For details of the EC column system please see page 250.

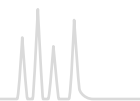

NUCLEOSHELL® Phenyl-Hexyl nonpolar high density phase · USP L11

★ Key feature

- Based on core-shell particle technology for fast and efficient HPLC
- Hydrophobic phase with alternative selectivity compared to classical C₁₈ modifications
- Separation principle based on 2 retention mechanisms: π-π interactions and hydrophobic interactions

🔧 Technical data

- Phenyl-Hexyl modification, multi-end-capped; pore size 90 Å, particle size 2.7 μm; carbon content 4.5 %; pH stability 1–10; suitable for LC/MS

✓ Recommended application

- Aromatic and unsaturated compounds, polar compounds like pharmaceuticals, antibiotics

Phenyl-Hexyl modified phases offer an excellent separation efficiency especially for aromatic and unsaturated compounds with electron-withdrawing groups. The combination of hydrophobic and π-π interactions results in an alternative and interesting selectivity profile compared to C₁₈ or C₈ modifications. NUCLEOSHELL® Phenyl-Hexyl is based on a unique surface bonding chemistry - therefore it is suitable for LC/MS due to low bleeding characteristics and offers high temperature stability and pH stability from 1 to 10.

Stability of NUCLEOSHELL® Phenyl-Hexyl at pH 10

MN Appl. No. 126420

Column: 50 x 4 mm NUCLEOSHELL® Phenyl-Hexyl, 2.7 μm
Eluent: acetonitrile – 50 mmol/L TEA pH 10 (60:40, v/v); pH of the mixture 10.4
Flow rate: 1 mL/min
Temperature: 40 °C
Detection: UV, 254 nm
Injection: 1 μL

Peaks:

1. Phenol
2. Naphthalene
3. Anthracene

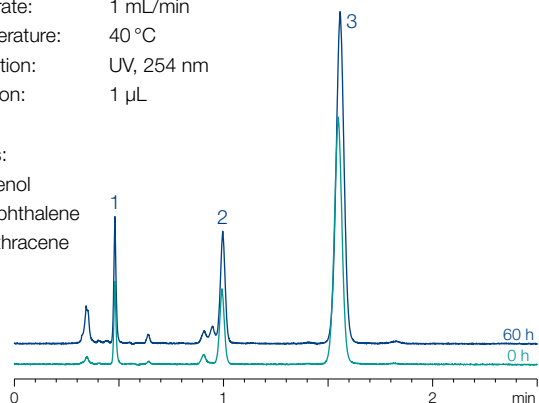

Relative plate numbers

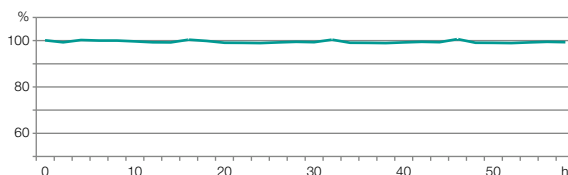

NUCLEOSHELL® Phenyl-Hexyl is a robust phase with an alternative RP selectivity for aromatic and unsaturated analytes compared to classical C₁₈ / C₈ phases – it is an additional and useful tool for all chromatography users.

Bleeding characteristics of NUCLEOSHELL® Phenyl-Hexyl

MN Appl. No. 126400

Columns: 50 x 2 mm each
NUCLEOSHELL® Phenyl-Hexyl, 2.7 μm
Kinetex® Phenyl-Hexyl
Eluent: A) acetonitrile, B) water
5–95 % A in 25 min
Flow rate: 0.2 mL/min
Temperature: 25 °C
Detection: MS

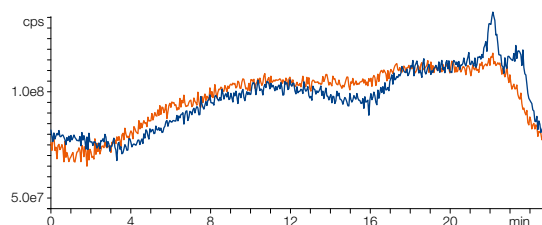

The pyridine-phenol test shows that NUCLEOSHELL® Phenyl-Hexyl provides a symmetrical peak for pyridine and higher resolution in comparison to other core-shell based Phenyl-Hexyl phases, which underlines the excellent base deactivation.

Pyridine-phenol test of NUCLEOSHELL® Phenyl-Hexyl

MN Appl. No. 126410

Columns: 50 x 2 mm each
NUCLEOSHELL® Phenyl-Hexyl, 2.7 μm
Kinetex® Phenyl-Hexyl
Ascentis® Express Phenyl-Hexyl
Eluent: acetonitrile – water (70:30, v/v)
Flow rate: 0.3 mL/min
Temperature: 40 °C
Detection: UV, 254 nm
Injection: 0.2 μL

- Peaks:
1. Pyridine
 2. Phenol

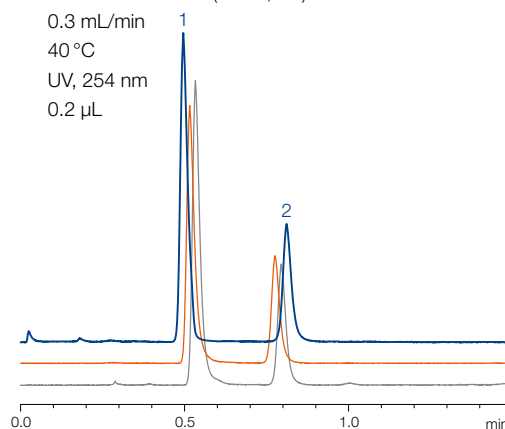



Comparing the separation of sulfonamides on NUCLEODUR® Phenyl-Hexyl with different particle sizes

MN Appl. No. 125860

Columns: 150 x 3 mm each
 NUCLEOSHELL® Phenyl-Hexyl, 2.7 µm
 NUCLEODUR® Phenyl-Hexyl, 1.8 µm
 NUCLEODUR® Phenyl-Hexyl, 3 µm
 NUCLEODUR® Phenyl-Hexyl, 5 µm

Eluent: A) methanol
 B) 0.1 % formic acid in water
 20–80 % A in 10 min

Flow rate: 0.56 mL/min
 Temperature: 40 °C
 Detection: UV, 254 nm
 Injection: 0.5 µL

- Peaks:
1. Sulfadiazine
 2. Sulfachlorpyridazine
 3. Sulfapyridine
 4. Sulfamerazine
 5. Sulfadimidine
 6. Sulfathiazole
 7. Sulfadimethoxine

On NUCLEOSHELL® Phenyl-Hexyl the resolution of the last two peaks is higher than on the fully porous 1.8 µm NUCLEODUR® Phenyl-Hexyl.

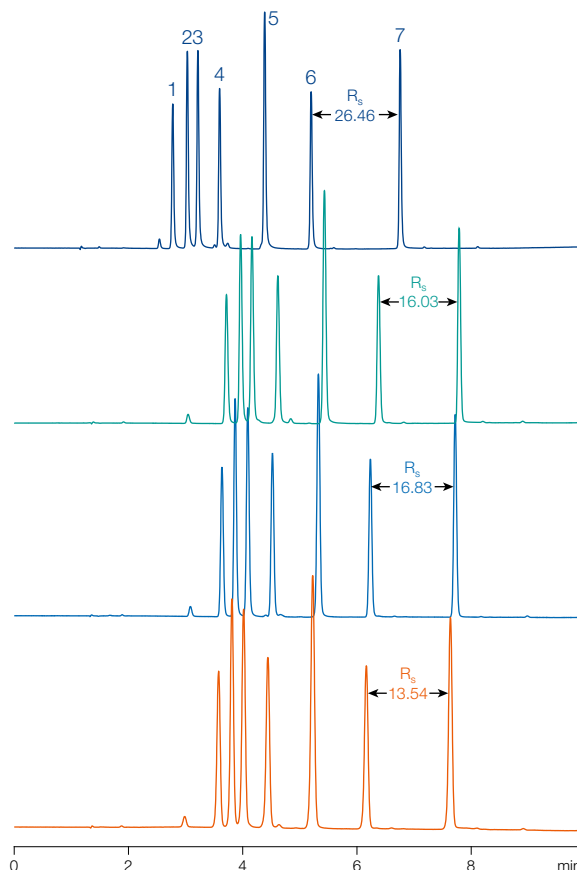

The separation of sulfonamides proves the scalability from fully porous NUCLEODUR® to NUCLEOSHELL® Phenyl-Hexyl. Hereby the core-shell silica exhibits identical selectivity, narrower peaks and slightly shorter retention under the same conditions.

Thus, method transferability between NUCLEODUR® and NUCLEOSHELL® is guaranteed, either for speeding up your methods or scaling up for preparative requirements.

Ordering information

Eluent in column acetonitrile – water

ID	Length →	100 mm			150 mm			EC guard columns*
		50 mm	100 mm	150 mm	50 mm	100 mm	150 mm	
NUCLEOSHELL® Phenyl-Hexyl, 2.7 µm particle size 2.7 µm								
Analytical EC columns								
	2 mm	763732.20	763734.20	763736.20				763738.20
	3 mm	763732.30	763734.30	763736.30				763738.30
	4 mm	763732.40	763734.40	763736.40				763738.30
	4.6 mm	763732.46	763734.46	763736.46				763738.30

EC columns in packs of 1, guard columns in packs of 3.

Guard column system

Guard columns for EC columns with ID		2 mm	3 mm	4 mm	4.6 mm	Guard column holder
* Column Protection System (pack of)	EC	4/2 (3)	4/3 (3)	4/3 (3)	4/3 (3)	718966

For details of the EC column system please see page 250.

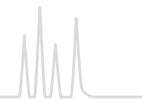

NUCLEOSHELL® PFP hydrophobic pentafluorophenyl phase · USP L43

★ Key feature

- Core-shell technology for fast and efficient HPLC
- Hydrophobic phase with alternative selectivity in comparison to classical C₁₈ modifications
- Separation principle based on 4 retention mechanisms (polar interactions (H bonds), dipole-dipole, π-π, hydrophobic interactions)

🔧 Technical data

- Phase with pentafluorophenylpropyl modification, multi-encapsulation; pore size 90 Å, particle size 2.7 µm; carbon content ~ 3%; pH stability 1–9; suitable for LC/MS

✓ Recommended application

- Aromatic and unsaturated compounds, phenols, halogen compounds, isomers, polar compounds like pharmaceuticals, antibiotics; strong retention of basic compounds

Orthogonality in selectivity

Fluorinated stationary phases in HPLC have gained increasing interest over the last years. Most common representative of fluorinated silica phases is the pentafluorophenyl modification (PFP or F₅). Especially the orthogonal selectivity compared to traditional alkyl phases widens the scope in analytical HPLC. Thus NUCLEOSHELL® PFP offers an excellent selectivity especially for highly polar analytes, aromatic and unsaturated compounds, phenols or halogenated hydrocarbons.

While a typical C₁₈ phase just provides hydrophobic interactions between stationary phase and analyte NUCLEOSHELL® PFP offers four different retention mechanisms: polar interactions (H bonds), dipole-dipole interactions, π-π interactions and hydrophobic interactions. Especially the pronounced ion exchange capacity and distinct steric selectivity are typical for the character of fluorinated phases.

Stability of NUCLEOSHELL® PFP at pH 1

MN Appl. No. 125560

Columns: 100 x 4.6 mm NUCLEOSHELL® PFP, 2.7 µm
100 x 4.6 mm Kinetex® PFP, 2.6 µm F5
Eluent: acetonitrile – 0.5 % TFA, pH 1 (50:50, v/v)
Flow rate: 1.3 mL/min
Temperature: 60 °C
Detection: UV, 254 nm
Sample: ethylbenzene

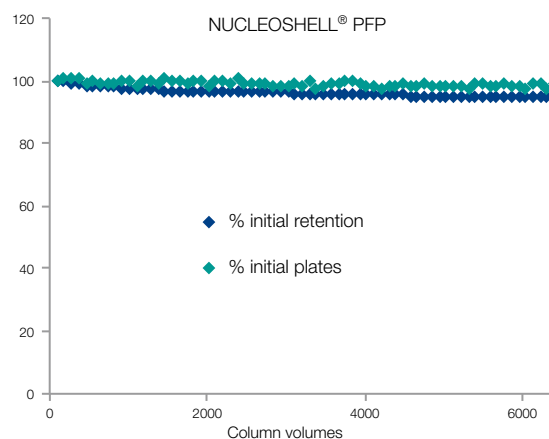

β-Blockers · orthogonal selectivity of NUCLEOSHELL® PFP

MN Appl. No. 125610

Columns: 100 x 4.6 mm
NUCLEOSHELL® RP 18, 2.7 µm
NUCLEOSHELL® PFP, 2.7 µm
Eluent: A) acetonitrile + 0.1 % formic acid
B) 0.1 % formic acid
10–35 % A in 2.5 min, 35–50 % A in 2 min
Flow rate: 1.7 mL/min
Temperature: 25 °C
Detection: UV, 280 nm

Peaks:

- | | |
|----------------|----------------|
| 1. Atenolol | 4. Labetalol |
| 2. Pindolol | 5. Alprenolol |
| 3. Metroprolol | 6. Propranolol |

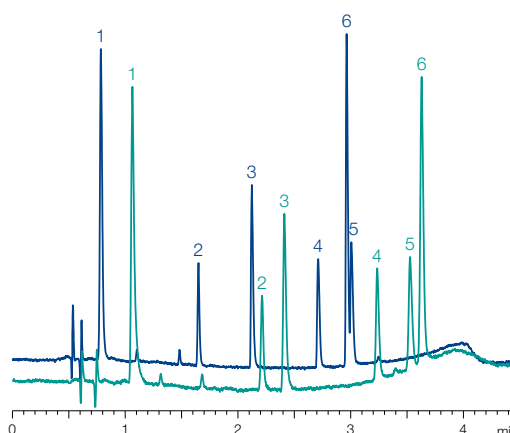

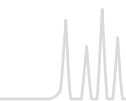

Methylacetophenones

MN Appl. No. 125590

Columns: 100 x 4.6 mm NUCLEOSHELL® PFP, 2.7 µm
 250 x 4 mm NUCLEODUR® PFP, 5 µm
 100 x 4.6 mm Kinetex® 2.6 µm F5
 Eluent: Methanol – water (35:65, v/v)
 Flow rate: 1.5 mL/min, 3 mL/min, 1 mL/min, 1.5 mL/min
 Temperature: 35 °C
 Detection: UV, 254 nm

Peaks:
 1. *o*-Methylacetophenone
 2. *p*-Methylacetophenone
 3. *m*-Methylacetophenone

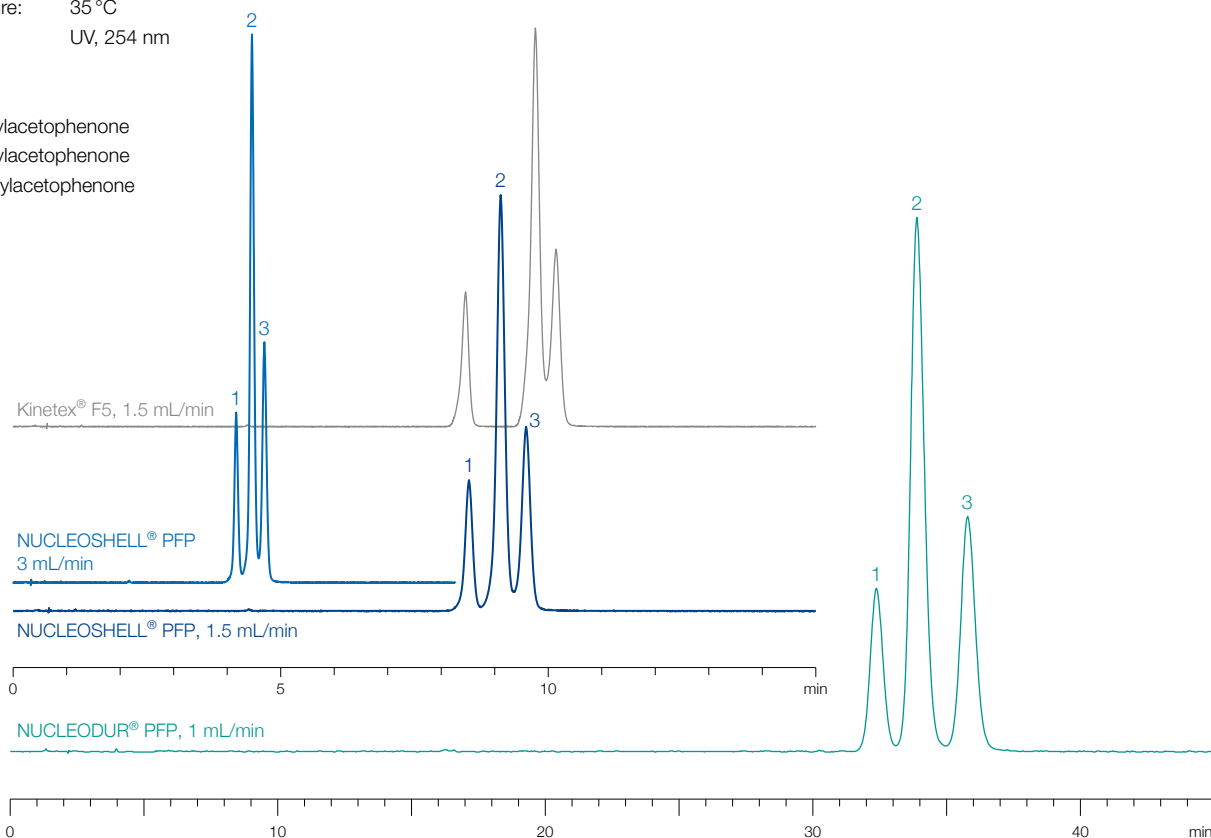

NUCLEOSHELL® PFP combines the benefits of core-shell technology, high stability, and orthogonal selectivity. Thus it is a useful complementary tool for highly efficient separations especially of isomers, halogenated, aromatic and / or polar compounds.

Ordering information

Eluent in column acetonitrile – water

ID	Length → 50 mm	100 mm			150 mm		EC guard columns*
NUCLEOSHELL® PFP, 2.7 µm particle size 2.7 µm							
Analytical EC columns							
	2 mm	763532.20	763534.20	763536.20	763538.20		763538.20
	3 mm	763532.30	763534.30	763536.30	763538.30		763538.30
	4 mm	763532.40	763534.40	763536.40	763538.30		763538.30
	4.6 mm	763532.46	763534.46	763536.46	763538.30		763538.30

EC columns in packs of 1, guard columns in packs of 3.

Guard column system

Guard columns for EC columns with ID		2 mm	3 mm	4 mm	4.6 mm	Guard column holder
* Column Protection System (pack of)	EC	4/2 (3)	4/3 (3)	4/3 (3)	4/3 (3)	718966

For details of the EC column system please see page 250.



NUCLEOSHELL® HILIC zwitterionic phase

★ Key feature

- Core-shell technology for fast and efficient HPLC
- Ideal for reproducible and stable chromatography of highly polar analytes
- Very short column equilibration times

🔧 Technical data

- Ammonium - sulfonic acid modified silica; pore size 90 Å, particle size 2.7 µm; carbon content 1.3 %; pH stability 2–8.5; suitable for LC/MS

✓ Recommended application

- Hydrophilic compounds such as polar organic acids and bases, polar natural compounds, nucleosides, oligonucleotides, amino acids, peptides, water-soluble vitamins

Hydrophilic interaction chromatography

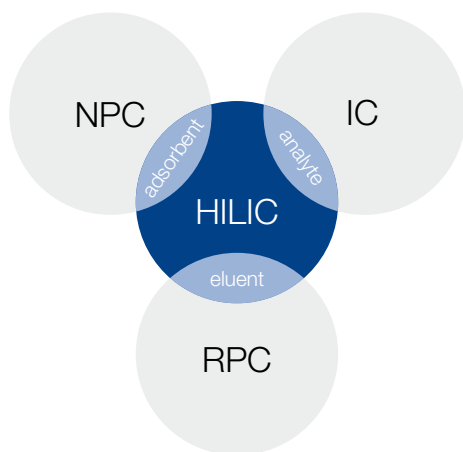

Hydrophilic interaction chromatography (HILIC) is a separation technique using polar stationary phases and organic-aqueous mobile phases. A minimum water content of at least 2 % is indispensable to provide a permanent water layer between the adsorbent surface and the organic fraction of the mobile phase. The sample molecules become separated in a partition chromatography, in which polar analytes are more strongly retained than neutral, less hydrophilic compounds. Consequently, increasing the aqueous part in the mobile phase will diminish retention of the polar sample constituents. In this way HILIC behaves inverse to classical RP chromatography. The particular retention profile of HILIC enables the chromatography of very polar and often small molecules, which won't show any retention on C₈ or C₁₈ reversed phases.

Ultra-fast separations at moderate back pressure

NUCLEOSHELL® HILIC is a core-shell technology based stationary phase with a covalently bonded 3-*N,N*-dimethylamino-propane sulfonic acid ligand (pat. p nd.). The betaine character of the strong ion-exchanger results in full charge balancing and facilitates fast equilibration times.

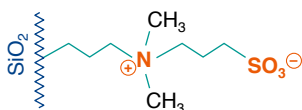

Good separation of polar compounds like the physiologically important substances creatine and creatinine can be achieved on NUCLEOSHELL® HILIC as well as on NUCLEODUR® HILIC, 1.8 µm at similar retention, but much lower back pressure.

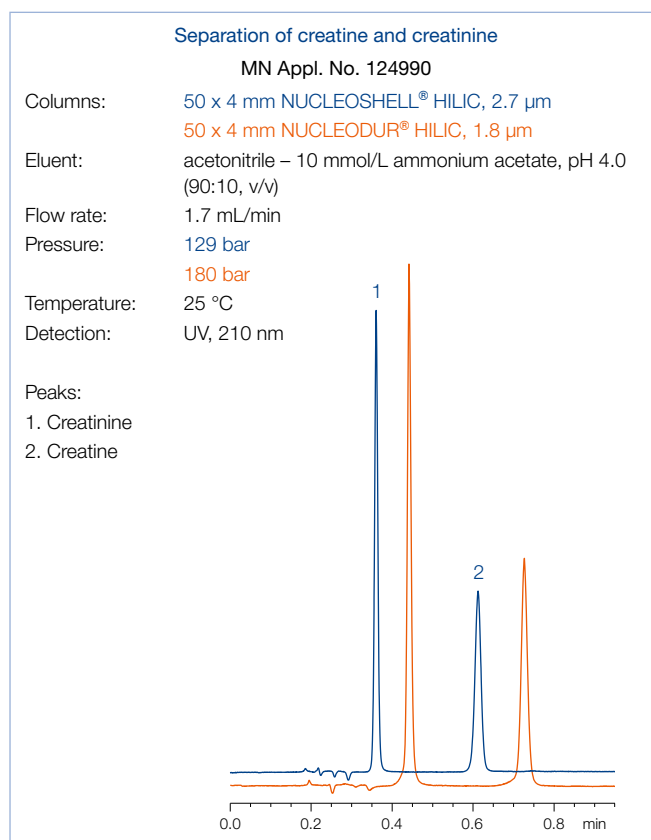

The following chromatograms show the method transfer from a fully porous 3 µm HILIC phase to 2.7 µm core-shell silica with equal selectivity features.

Run time has been cut down to 1 min. Column back pressure remains modest < 400 bar, while solvent demand is reduced to less than 35 %.



Separation of catecholamines

MN Appl. No. 125440

Columns: 100 x 4 mm NUCLEOSHELL® HILIC, 2.7 µm
 100 x 4 mm NUCLEOSHELL® HILIC, 2.7 µm
 250 x 4 mm NUCLEODUR® HILIC, 3 µm

Eluent: acetonitrile – 100 mmol/L ammonium formate, pH 3.2 (80:20, v/v)

Flow rate: 4 mL/min, 1 mL/min, 1 mL/min

Pressure: 395 bar, 95 bar, 116 bar

Temperature: 25 °C

Detection: UV, 280 nm

Peaks:

1. DOPAC	5. Norepinephrine
2. Serotonin	6. DOPA
3. Dopamine	7. DOPS
4. Epinephrine	

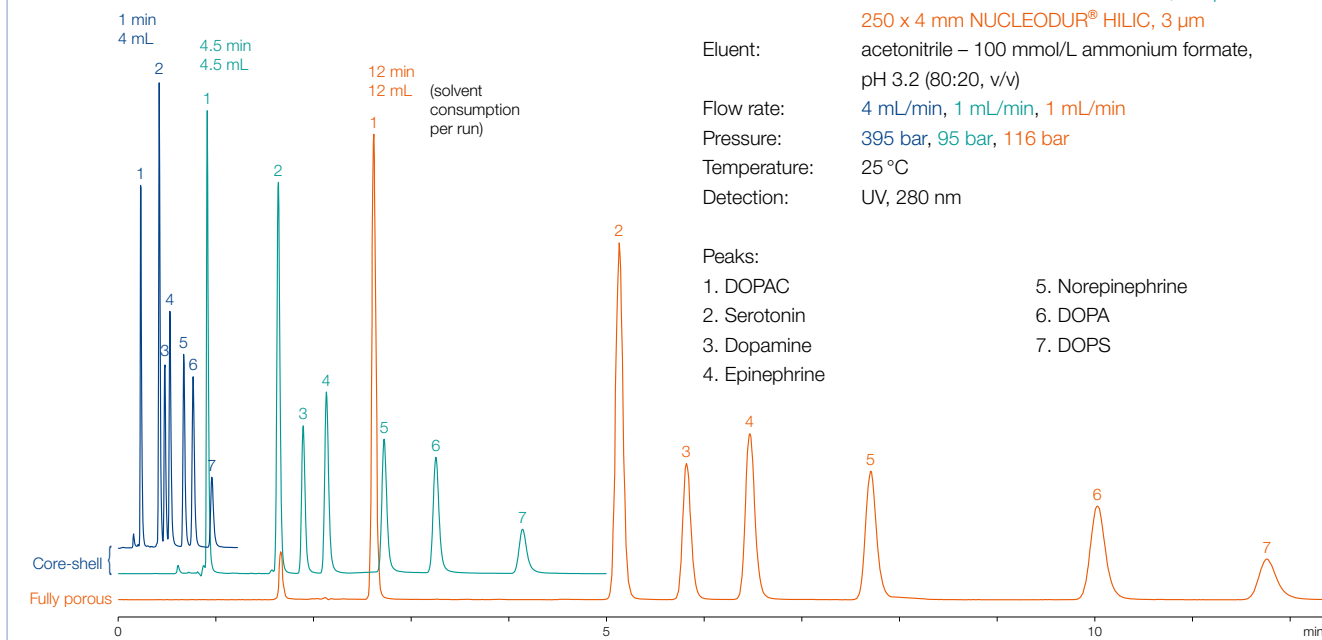

Core-shell silica: separation in 1 min pressure < 400 bar

NUCLEOSHELL® HILIC provides stable and reproducible chromatography, comprising all the benefits of a state-of-the-art core-shell silica.

Ordering information

Eluent in column acetonitrile – water

ID	Length → 50 mm	100 mm			150 mm			EC guard columns*
		NUCLEOSHELL® HILIC, 2.7 µm particle size 2.7 µm			NUCLEOSHELL® HILIC, 2.7 µm particle size 2.7 µm			
Analytical EC columns								
	2 mm	763332.20	763334.20	763336.20	763338.20			763338.20
	3 mm	763332.30	763334.30	763336.30	763338.30			763338.30
	4 mm	763332.40	763334.40	763336.40	763338.40			763338.40
	4.6 mm	763332.46	763334.46	763336.46	763338.46			763338.46

EC columns in packs of 1, guard columns in packs of 3.

Guard column system

Guard columns for EC columns with ID	2 mm	3 mm	4 mm	4.6 mm	Guard column holder
* Column Protection System (pack of)	EC 4/2 (3)	4/3 (3)	4/3 (3)	4/3 (3)	718966

For details of the EC column system please see page 250.

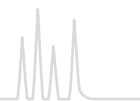

MACHEREY-NAGEL Column Protection System

The guard column system for HPLC / UHPLC from MN

- Ideal protection for your analytical main column:
significant increase in column lifetime
- Minimized void volume:
suitable also for ultra fast HPLC (UHPLC)
- Special ferrules:
pressure stability up to 1300 bar (18850 psi)
- Cartridges filled with NUCLEODUR[®], NUCLEOSIL[®] and NUCLEOSHELL[®] HPLC adsorbents.
- Universal screw-on guard column holder system
- Suitable for all analytical HPLC columns with 1/16" fittings

Further information on page 251.





NUCLEOSIL[®]

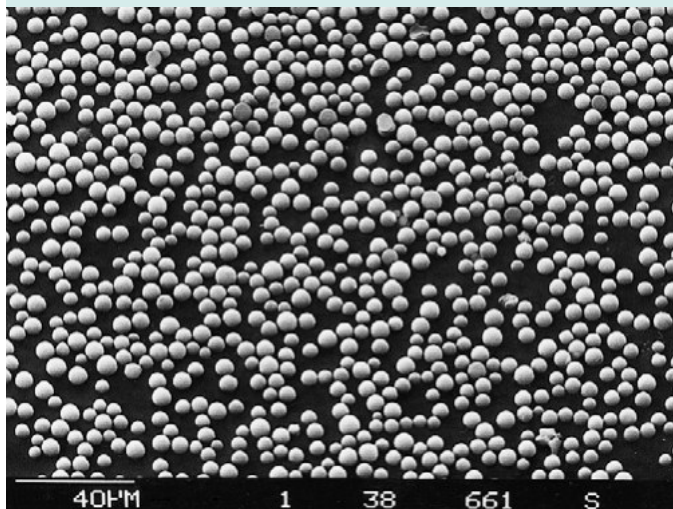

Key feature

- NUCLEOSIL[®] is a family of totally porous spherical silicas. They feature a very pure and uniform SiO₂ structure and have gained wide acceptance as routine chromatographic packings for very different fields of modern chromatography.
- One of the first spherical silicas used in HPLC
- Developed in the early seventies, it became a world-renowned HPLC packing
- Absolutely reliable choice for routine analyses
- Largest variety of modified HPLC silicas available
- pH stability 2–8 (for NUCLEOSIL[®] 100-5 C₁₈ AB 1–9)
- Due to its particle sizes NUCLEOSIL[®] finds application in analytical as well as in preparative columns.

Benefits of NUCLEOSIL[®] silica

- High efficiency due to narrow particle size distribution
- High separation performance due to optimized binding techniques
- High chemical and mechanical stability
- High load capacity and recovery rates
- High reproducibility from lot to lot

Physical properties

NUCLEOSIL[®] is manufactured with different pore diameters (50, 100, 120, 300, 500, 1000 and 4000 Å) and particle sizes from 3 μm (only NUCLEOSIL[®] 50, 100 and 120) to 10 μm with very narrow fractionation. All narrow-pore NUCLEOSIL[®] packings are stable up to 500 bar (7 250 psi), the wide-pore NUCLEOSIL[®] silicas are stable up to 300 or 400 bar (4 200 or 5 600 psi).

Physical properties of unmodified NUCLEOSIL[®] materials

Phase	Pore size	Pore volume	Surface (BET)	Density	Pressure stability*
NUCLEOSIL [®] 50	50 Å	0.8 mL/g	420 m ² /g	0.45 g/mL	500 bar
NUCLEOSIL [®] 100	100 Å	1 mL/g	350 m ² /g	0.36 g/mL	500 bar
NUCLEOSIL [®] 120	120 Å	0.65 mL/g	200 m ² /g	0.55 g/mL	500 bar
NUCLEOSIL [®] 300	300 Å	0.8 mL/g	100 m ² /g	0.45 g/mL	400 bar
NUCLEOSIL [®] 500	500 Å	0.8 mL/g	35 m ² /g	0.45 g/mL	400 bar
NUCLEOSIL [®] 1000	1000 Å	0.8 mL/g	25 m ² /g	0.45 g/mL	300 bar
NUCLEOSIL [®] 4000	4000 Å	0.7 mL/g	10 m ² /g	0.48 g/mL	300 bar

* Maximum packing pressure of NUCLEOSIL[®] bulk packings

NUCLEOSIL[®] modifications

- NUCLEOSIL[®] packings are available as unmodified silica or with numerous chemically bonded phases: RP phases like C₁₈ AB, C₁₈ HD, C₁₈ Nautilus, C₁₈, C₁₈ ec, Protect I, C₈ HD, C₈ ec, C₈, C₄, C₂ and C₆H₅ separate mainly by hydrophobic interactions (van der Waals forces). The less polar the sample molecules, the more they are retained – the more polar the sample, the weaker are the hydrophobic interactions and consequently the retention times are shorter.
- Phases with chemically bonded polar groups such as CN, NH₂, N(CH₃)₂, OH show selective separation properties. Due to the availability of different functional groups it is possible to vary the chemical characteristics of the surface and consequently the adsorption characteristics of the stationary phase.

sible to vary the chemical characteristics of the surface and consequently the adsorption characteristics of the stationary phase.

- Silica-based ion exchangers (NUCLEOSIL[®] SA and SB) are stable from pH 2 to 8 and do not swell. Compared to resin-based ion exchangers they offer the advantage of constant permeability, even when the ionic strength and/or pH of the eluent are changed. The separation can be influenced by
 - the type of buffer
 - the ionic strength and
 - the pH value.







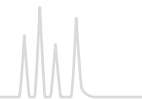



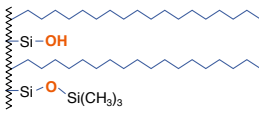

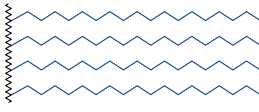

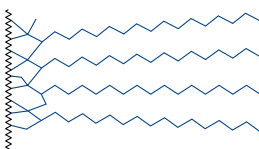

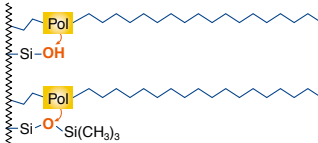
A tabular overview of NUCLEOSIL[®] phases can be found on page 212.

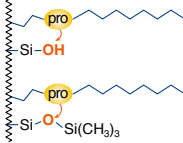

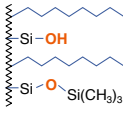
NUCLEOSIL[®] phase overview

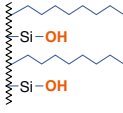

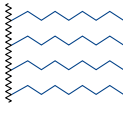
Overview of NUCLEOSIL[®] HPLC phases

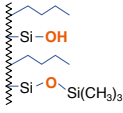

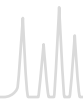







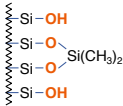

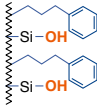

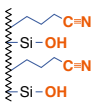

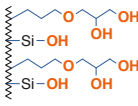
Phase	Specification	Page	Stability	Interactions	Structure
NUCLEOSIL [®] RP-Phasen					
 C ₁₈	octadecyl phase, medium density modification, endcapping 15% C · USP L1	214	pH 2–8	hydrophobic (van der Waals) interactions slight residual silanol interactions	NUCLEOSIL [®] (Si-O ₂) _n 
 C ₁₈ HD	octadecyl phase, high density monomeric modification, endcapping 20% C · USP L1	214	pH 2–8	hydrophobic (van der Waals) interactions	NUCLEOSIL [®] (Si-O ₂) _n 
 C ₁₈ AB	octadecyl phase, special crosslinked modification, endcapping 25% C · USP L1	214	pH 1–9	steric and hydrophobic interactions	NUCLEOSIL [®] (Si-O ₂) _n 
 C ₁₈ Nautilus	octadecyl phase, embedded polar group, endcapping 16% C · USP L60	214	pH 2–8 up to 100% H ₂ O	hydrophobic and polar interactions	NUCLEOSIL [®] (Si-O ₂) _n 
 Protect I	special RP phase, protective polar group, monomeric modification, endcapping 11% C	216	pH 2–8 up to 100% H ₂ O	hydrophobic and polar interactions	NUCLEOSIL [®] (Si-O ₂) _n 
 C ₈ ec	octyl phase, medium density modification, endcapping 9% C · USP L7	217	pH 2–8	hydrophobic (van der Waals) interactions slight residual silanol interactions	NUCLEOSIL [®] (Si-O ₂) _n 
 C ₈	octyl phase, no endcapping 8.5% C · USP L7	217	pH 2–8	hydrophobic (van der Waals) interactions interactions noticeable residual silanol interactions	NUCLEOSIL [®] (Si-O ₂) _n 
 C ₈ HD	octyl phase, high density modification, endcapping 13% C · USP L7	218	pH 2–8	hydrophobic (van der Waals) interactions	NUCLEOSIL [®] (Si-O ₂) _n 
 C ₄	butyl phase, medium density modification, endcapping ~ 2% C · USP L26	219	pH 2–8	hydrophobic (van der Waals) interactions residual silanol interactions	NUCLEOSIL [®] (Si-O ₂) _n 

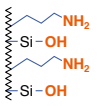

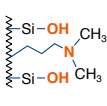
NUCLEOSIL[®] phase overview

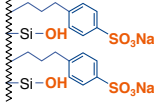

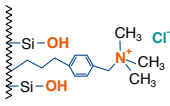
Overview of NUCLEOSIL[®] HPLC phases

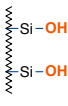
Phase	Specification	Page	Stability	Interactions	Structure
 C ₂	dimethyl phase 3.5% C · USP L16	219	pH 2–8	hydrophobic (van der Waals) interactions noticeable residual silanol interactions	NUCLEOSIL [®] (Si-O ₂) _n 
 C ₆ H ₅	phenyl phase, no endcapping 8% C · USP L11	220	pH 2–8	π-π interactions and hydrophobic interactions noticeable residual silanol interactions	NUCLEOSIL [®] (Si-O ₂) _n 
Polar NUCLEOSIL [®] phases and NUCLEOSIL [®] ion exchangers					
 CN / CN-RP	cyano (nitrile) phase USP L10	222	pH 2–8	π-π, polar and hydrophobic interactions	NUCLEOSIL [®] (Si-O ₂) _n 
 OH (Diol)	diol · USP L20	220	pH 2–8	polar interactions (hydrogen bonds)	NUCLEOSIL [®] (Si-O ₂) _n 
 NH ₂ / NH ₂ -RP	amino · USP L8	221	pH 2–8	polar and hydrophobic interactions, weak ion exchange interactions	NUCLEOSIL [®] (Si-O ₂) _n 
 N(CH ₃) ₂	dimethylamino	221	pH 2–8	polar and hydrophobic interactions, weak ion exchange interactions	NUCLEOSIL [®] (Si-O ₂) _n 
 SA	sulfonic acid, strongly acid cation exchanger (SCX) USP L9	223	pH 2–8	strong ion exchange interactions	NUCLEOSIL [®] (Si-O ₂) _n 
 SB	quaternary ammonium, strongly basic anion exchanger (SAX) USP L14	223	pH 2–8	strong ion exchange interactions	NUCLEOSIL [®] (Si-O ₂) _n 
 SiOH	unmodified spherical silica USP L3	224	pH 2–8	polar	NUCLEOSIL [®] (Si-O ₂) _n 



NUCLEOSIL[®] octadecyl phases (C₁₈)

NUCLEOSIL[®] standard octadecyl phases · USP L1

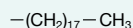

Technical data

- Nonpolar phases
- pH stability at 20 °C: 2–8
- carbon content depending on pore size (see table)

- Corresponding NUCLEODUR[®] phases see C₁₈ ec page 181

NUCLEOSIL[®] C₁₈ HD · USP L1

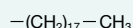

Technical data

- Nonpolar hydrophobic high density phases; monomeric modification
- pH stability 2–9

- Carbon content 20 %
- Corresponding NUCLEODUR[®] phases see C₁₈ Gravity page 158

NUCLEOSIL[®] C₁₈ AB · USP L1

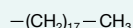

Technical data

- Crosslinked hydrophobic phase; polymeric modification; inert towards acidic and basic substances with high affinity for silica
- pH stability 1–9

- Carbon content 25 %; distinct steric selectivity
- Corresponding NUCLEODUR[®] phases see C₁₈ Isis page 164

NUCLEOSIL[®] C₁₈ Nautilus · USP L60

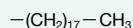

Technical data

- Stable in 100 % aqueous eluents
- Carbon content 16 %
- Interesting polar selectivity features; very good base deactivation

- Corresponding NUCLEODUR[®] phases see C₁₈ PolarTec page 168

All NUCLEOSIL[®] octadecyl phases are endcapped.

Custom-packed columns with different column dimensions are available on request.

Ordering information

Eluent in column acetonitrile – water

ID	Length →					EC guard columns*
	100 mm	125 mm	150 mm	250 mm		
NUCLEOSIL[®] 50-5 C₁₈ ec particle size 5 μm, pore size 50 Å, endcapped, 14.5 % C						
Analytical EC columns						
4.6 mm				720098.46		721473.30
NUCLEOSIL[®] 100-3 C₁₈ particle size 3 μm, pore size 100 Å, endcapped, 15 % C						
Analytical EC columns						
4 mm		720150.40		720133.40		721022.30
4.6 mm	720841.46	720150.46	720949.46	720133.46		721022.30
NUCLEOSIL[®] 100-5 C₁₈ particle size 5 μm, pore size 100 Å, endcapped, 15 % C						
Analytical EC columns						
2 mm		720002.20		720014.20		721074.20
3 mm		720002.30		720014.30		721074.30
4 mm	720141.40	720002.40	720120.40	720014.40		721074.30
4.6 mm	720141.46	720002.46	720120.46	720014.46		721074.30



Ordering information

Eluent in column acetonitrile – water

ID	Length →					EC guard columns*
	100 mm	125 mm	150 mm	250 mm		
NUCLEOSIL[®] 100-7 C₁₈ particle size 7 μm, pore size 100 Å, endcapped, 15 % C						
Analytical EC columns						
	4 mm				720018.40	
	4.6 mm	720951.46		720110.46	720018.46	
NUCLEOSIL[®] 100-10 C₁₈ particle size 10 μm, pore size 100 Å, endcapped, 15 % C						
Analytical EC columns						
	4 mm				720023.40	
	4.6 mm	720701.46		720140.46	720023.46	
NUCLEOSIL[®] 120-3 C₁₈ particle size 3 μm, pore size 120 Å, endcapped, 11 % C						
Analytical EC columns						
	4 mm	720149.40	720040.40		720055.40	721075.30
	4.6 mm	720149.46	720040.46	720740.46	720055.46	721075.30
NUCLEOSIL[®] 120-5 C₁₈ particle size 5 μm, pore size 120 Å, endcapped, 11 % C						
Analytical EC columns						
	4 mm		720051.40		720041.40	721070.30
	4.6 mm		720051.46	720730.46	720041.46	721070.30
NUCLEOSIL[®] 120-7 C₁₈ particle size 7 μm, pore size 120 Å, endcapped, 11 % C						
Analytical EC columns						
	4 mm				720042.40	
NUCLEOSIL[®] 120-10 C₁₈ particle size 10 μm, pore size 120 Å, endcapped, 11 % C						
Analytical EC columns						
	4 mm				720043.40	
	4.6 mm				720043.46	
NUCLEOSIL[®] 100-3 C₁₈ HD particle size 3 μm, pore size 100 Å, 20 % C						
Analytical EC columns						
	4 mm		720191.40			721196.30
	4.6 mm		720191.46	720193.46		721196.30
NUCLEOSIL[®] 100-5 C₁₈ HD particle size 5 μm, pore size 100 Å, 20 % C						
Analytical EC columns						
	4 mm		720296.40		720280.40	721072.30
	4.6 mm		720296.46	720294.46	720280.46	721072.30
NUCLEOSIL[®] 100-5 C₁₈ AB particle size 5 μm, pore size 100 Å, 25 % C						
Analytical EC columns						
	4 mm		720935.40		720936.40	721073.30
	4.6 mm		720935.46	720305.46	720936.46	721073.30
NUCLEOSIL[®] 100-3 C₁₈ Nautilus particle size 3 μm, pore size 100 Å, 16 % C						
Analytical EC columns						
	4 mm		720472.40			721649.30
	4.6 mm		720472.46	720471.46		721649.30
NUCLEOSIL[®] 100-5 C₁₈ Nautilus particle size 5 μm, pore size 100 Å, 16 % C						
Analytical EC columns						
	4 mm		720430.40		720431.40	721133.30
	4.6 mm		720430.46	720432.46	720431.46	721133.30

Guard column system

Guard columns for EC columns with ID		2 mm	3 mm	4 mm	4.6 mm	Guard column holder
* Column Protection System (pack of)	EC	4/2 (3)	4/3 (3)	4/3 (3)	4/3 (3)	718966

EC columns in packs of 1, guard columns in packs of 3. For details of our column systems see page 250.



NUCLEOSIL[®] octadecyl phases (C₁₈) wide pore octadecyl phases · USP L1

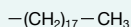

Technical data

• Many biologically interesting molecules can not be separated using conventional narrow pore silicas with pore sizes of about 100 Å. This is why MACHEREY-NAGEL offers a complete line of wide pore packings with pore sizes of 300, 500, 1000 and 4000 Å.



• These materials can also be used for size exclusion chromatography (SEC).

All NUCLEOSIL[®] octadecyl phases are endcapped.

Custom-packed columns with different column dimensions are available on request.

Ordering information

Eluent in column acetonitrile – water

ID	Length →			EC guard columns*
	125 mm	150 mm	250 mm	
NUCLEOSIL[®] 300-5 C₁₈ particle size 5 µm, pore size 300 Å, endcapped, 6.5 % C				
Analytical EC columns				
	4 mm		720065.40	721085.30
	4.6 mm		720065.46	721085.30
NUCLEOSIL[®] 500-7 C₁₈ particle size 7 µm, pore size 500 Å, endcapped, 2 % C				
Analytical EC columns				
	4.6 mm		720074.46	
NUCLEOSIL[®] 1000-7 C₁₈ particle size 7 µm, pore size 1000 Å, endcapped, ~ 1 % C				
Analytical EC columns				
	4.6 mm		720077.46	

EC columns in packs of 1, guard columns in packs of 3.

VarioPrep preparative HPLC columns with NUCLEOSIL[®] packing material on request.

NUCLEOSIL[®] 100 Protect I special RP phase with protective polar group

Technical data

- RP phase with pronounced hydrophilic properties
- Endcapped
- Monomeric coating
- Carbon content 11 %

Ordering information

Eluent in column acetonitrile – water

ID	Length →				EC guard columns*
	125 mm	150 mm	250 mm	250 mm	
NUCLEOSIL[®] 100-5 Protect I particle size 5 µm, pore size 100 Å					
Analytical EC columns					
	4 mm	720175.40		720170.40	721157.30
	4.6 mm	720175.46	720174.46	720170.46	721157.30

Guard column system

Guard columns for EC columns with ID	2 mm	3 mm	4 mm	4.6 mm	Guard column holder
* Column Protection System (pack of)	EC 4/2 (3)	4/3 (3)	4/3 (3)	4/3 (3)	718966

EC columns in packs of 1, guard columns in packs of 3. For details of our column systems see page 250.



NUCLEOSIL[®] octyl phases (C₈) NUCLEOSIL[®] standard octyl phases · USP L7

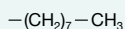

Technical data

- Nonpolar phases for RP and ion-pairing chromatography
- Endcapped and non-endcapped modifications available; pH stability at 20 °C: 2–8
- Carbon content depending on pore size (see table)

Recommended application

- Separation of moderately to highly polar (water-soluble) compounds: steroids, nucleosides, cyclodextrins, pharmacological plant constituents
- Corresponding NUCLEODUR[®] phases see C₈ ec page 183

Ordering information

Eluent in column acetonitrile – water

ID	Length →			
	125 mm	150 mm	250 mm	EC guard columns*
NUCLEOSIL[®] 100-5 C₈ ec particle size 5 μm, pore size 100 Å, endcapped, 9 % C				
Analytical EC columns				
4.6 mm			720165.46	721096.30
NUCLEOSIL[®] 100-5 C₈ particle size 5 μm, pore size 100 Å, not endcapped, 8.5 % C				
Analytical EC columns				
4 mm	720001.40		720013.40	721194.30
4.6 mm	720001.46	720990.46	720013.46	721194.30
NUCLEOSIL[®] 100-7 C₈ particle size 7 μm, pore size 100 Å, not endcapped, 8.5 % C				
Analytical EC columns				
4.6 mm			720017.46	
NUCLEOSIL[®] 100-10 C₈ particle size 10 μm, pore size 100 Å, not endcapped, 8.5 % C				
Analytical EC columns				
4 mm			720022.40	
4.6 mm			720022.46	
NUCLEOSIL[®] 120-3 C₈ particle size 3 μm, pore size 120 Å, not endcapped, 6.5 % C				
Analytical EC columns				
4 mm	720071.40			721093.30
4.6 mm	720071.46	720214.46		721093.30
NUCLEOSIL[®] 120-5 C₈ particle size 5 μm, pore size 120 Å, not endcapped, 6.5 % C				
Analytical EC columns				
4 mm	720050.40		720052.40	721095.30
4.6 mm	720050.46	720735.46	720052.46	721095.30
NUCLEOSIL[®] 300-5 C₈ particle size 5 μm, pore size 300 Å, not endcapped, ~ 3 % C				
Analytical EC columns				
4.6 mm			720062.46	721061.30

EC columns in packs of 1, guard columns in packs of 3.

Custom-packed columns with different column dimensions are available on request.

Guard column system

Guard columns for EC columns with ID	2 mm	3 mm	4 mm	4.6 mm	Guard column holder
* Column Protection System (pack of)	EC	4/2 (3)	4/3 (3)	4/3 (3)	718966

EC columns in packs of 1, guard columns in packs of 3. For details of our column systems see page 250.



NUCLEOSIL[®] octyl phases (C₈) NUCLEOSIL[®] C₈ HD · USP L7

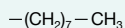

🔧 Technical data

- Nonpolar high density phases; monomeric modification; endcapped; carbon content 13 %
- Corresponding NUCLEODUR[®] phases see C₈ Gravity page 158

✓ Recommended application

- Separation of moderate to strong polar (water soluble) analytes like steroids, cyclodextrines, pharmaceutical plant ingredients

Ordering information

Eluent in column acetonitrile – water

ID	Length → 125 mm	150 mm	250 mm	EC guard columns*
----	--------------------	--------	--------	-------------------

NUCLEOSIL[®] 100-5 C₈ HD particle size 5 μm, pore size 100 Å

Analytical EC columns

	4 mm		720196.40	721071.30
	4.6 mm	720194.46	720196.46	721071.30

EC columns in packs of 1, guard columns in packs of 3.

Custom-packed columns with different column dimensions are available on request.

Guard column system

Guard columns for EC columns with ID		2 mm	3 mm	4 mm	4.6 mm	Guard column holder
* Column Protection System (pack of)	EC	4/2 (3)	4/3 (3)	4/3 (3)	4/3 (3)	718966

EC columns in packs of 1, guard columns in packs of 3. For details of our column systems see page 250.



Beside analytical HPLC columns we also produce VarioPrep columns (see page 252) for preparative applications.



NUCLEOSIL® butyl phases (C₄) · USP L26

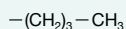

Technical data

- Endcapped phases for RP and ion-pairing chromatography
- pH stability at 20 °C: 2–8; carbon content ~ 2 %
- Retention times are shorter than on C₈ and C₁₈ phases

Recommended application

- For separation of macromolecules and hydrophobic substances
- For butyl phases for biochemical separations please refer to page 241

Ordering information

Eluent in column acetonitrile – water

ID	Length → 250 mm	EC guard columns*
----	--------------------	-------------------

NUCLEOSIL® 120-5 C₄ particle size 5 μm, pore size 120 Å

Analytical EC columns



4.6 mm

720096.46

721083.30

NUCLEOSIL® 300-5 C₄ particle size 5 μm, pore size 300 Å

Analytical EC columns



4 mm

720059.40

721916.30

4.6 mm

720059.46

721916.30

EC columns in packs of 1, guard columns in packs of 3.

Guard column system

Guard columns for EC columns with ID	2 mm	3 mm	4 mm	4.6 mm	Guard column holder
* Column Protection System (pack of)	EC 4/2 (3)	4/3 (3)	4/3 (3)	4/3 (3)	718966

NUCLEOSIL® dimethyl phase (C₂) · USP L16



Technical data

- Non-endcapped phase for RP and ion-pairing chromatography
- pH stability at 20 °C: 2–8; carbon content 3.5 %

- Retention times are much shorter than for the other RP phases

Ordering information

Eluent in column acetonitrile – water

ID	Length → 250 mm	EC guard columns*
----	--------------------	-------------------

NUCLEOSIL® 100-7 C₂ particle size 7 μm, pore size 100 Å

Analytical EC columns



4.6 mm

720089.46

721030.30

EC columns in packs of 1, guard columns in packs of 3. For details of our column systems see page 250.

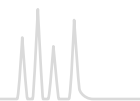

NUCLEOSIL[®] phenyl phases (C₆H₅) · USP L11

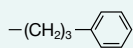

Technical data



- Relatively nonpolar, non-encapped phases for RP and ion pairing chromatography
- Polarity similar to C₈, but with different selectivity for PAHs, polar aromatics, fatty acids etc.
- pH stability at 20 °C: 2–8; carbon content 8 %

Recommended application

- Separation of moderately polar compounds

Ordering information

Eluent in column acetonitrile – water

ID	Length → 250 mm	EC guard columns*
NUCLEOSIL[®] 100-5 C₆H₅ particle size 5 μm, pore size 100 Å, not encapped		
Analytical EC columns		
 4.6 mm	720956.46	721137.30
NUCLEOSIL[®] 100-7 C₆H₅ particle size 7 μm, pore size 100 Å, not encapped		
Analytical EC columns		
 4 mm	720019.40	
 4.6 mm	720019.46	

NUCLEOSIL[®] diol phases · USP L20

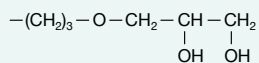

Technical data

- Dihydroxypropyl modified silica for RP and NP chromatography
- Less polar than unmodified silica, very easily wettable with water

- pH stability at 20 °C: 2-8; carbon content 5 %

Ordering information

Eluent in column is *n*-heptane. When using an eluent which is not miscible with *n*-heptane (e.g., water), it is necessary to rinse the column with THF first.

ID	Length → 250 mm	EC guard columns*
NUCLEOSIL[®] 100-5 OH (Diol) particle size 5 μm, pore size 100 Å		
Analytical EC columns		
 4.6 mm	720143.46	721142.30

Guard column system

Guard columns for EC columns with ID	2 mm	3 mm	4 mm	4.6 mm	Guard column holder
* Column Protection System (pack of)	EC 4/2 (3)	4/3 (3)	4/3 (3)	4/3 (3)	718966

EC columns in packs of 1, guard columns in packs of 3. For details of our column systems see page 250.



NUCLEOSIL[®] amino phases · USP L8

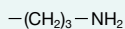

Technical data

- Aminopropyl modified polar silica phase; pH stability at 20 °C: 2–8; carbon content 3.5 %
- Corresponding NUCLEODUR[®] phases see page 188



Recommended application

Multi-mode chromatography

- NP chromatography with hexane, dichloromethane or 2-propanol as mobile phase for polar compounds such as substituted anilines, esters, chlorinated pesticides
- RP chromatography of polar compounds like carbohydrates in aqueous-organic eluent systems
- Anion exchange chromatography of anions and organic acids using common buffers (e.g., acetate or phosphate) in conjunction with organic modifiers (e.g., acetonitrile)

Ordering information

Eluent in column is *n*-heptane (except for NH₂ RP). When using an eluent which is not miscible with *n*-heptane (e.g., water), it is necessary to rinse the column with THF first.

ID	Length → 250 mm	EC guard columns*
NUCLEOSIL[®] 100-5 NH₂ particle size 5 μm, pore size 100 Å; eluent in column <i>n</i> -heptane		
Analytical EC columns		
 4.6 mm	720095.46	721020.30
NUCLEOSIL[®] 100-5 NH₂-RP particle size 5 μm, pore size 100 Å; eluent in column acetonitrile – water (80:20)		
Analytical EC columns		
 4.6 mm	720095.46RP	721155.30
NUCLEOSIL[®] 100-10 NH₂ particle size 10 μm, pore size 100 Å; eluent in column <i>n</i> -heptane		
Analytical EC columns		
 4.6 mm	720025.46	

NUCLEOSIL[®] dimethylamino phase

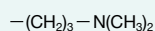

Technical data

- Weakly basic anion exchanger, pH stability at 20 °C: 2–8; carbon content 4 %

Recommended application

- Separation of many anions; can also be used in a similar way as the NH₂ phase

Ordering information

Eluent in column is *n*-heptane. When using an eluent which is not miscible with *n*-heptane (e.g., water), it is necessary to rinse the column with THF first.

ID	Length → 250 mm	EC guard columns*
NUCLEOSIL[®] 100-5 N(CH₃)₂ particle size 5 μm, pore size 100 Å		
Analytical EC columns		
 4.6 mm	720994.46	721158.30

Guard column system

Guard columns for EC columns with ID	2 mm	3 mm	4 mm	4.6 mm	Guard column holder
* Column Protection System (pack of)	EC 4/2 (3)	4/3 (3)	4/3 (3)	4/3 (3)	718966

EC columns in packs of 1, guard columns in packs of 3. For details of our column systems see page 250.



NUCLEOSIL[®] cyano phases · USP L10

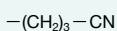

Technical data

- Polar to midpolar cyano (nitrile) modified silica
- pH stability at 20 °C: 2–8; carbon content 5 % for 100 Å pores, ~ 3 % for 120 Å pores
- Corresponding NUCLEODUR[®] phases see page 186









Recommended application

Reversed phase and normal phase chromatography

- Normal phase: with low-polarity solvents for many compounds, which can also be separated on unmodified silica, however, due to the rapid equilibration much more suitable for gradient separations
- Reversed phase: with different selectivity than C₁₈, C₈ or phenyl modified packings

Ordering information

Eluent in column (except for NUCLEOSIL[®] 100-5 CN-RP) is *n*-heptane. When using an eluent which is not miscible with *n*-heptane (e.g., water), it is necessary to rinse the column with THF first.

ID	Length → 250 mm	EC guard columns*
NUCLEOSIL[®] 100-5 CN particle size 5 µm, pore size 100 Å; eluent in column <i>n</i> -heptane		
Analytical EC columns		
 4 mm	720090.40	721078.30
 4.6 mm	720090.46	721078.30
NUCLEOSIL[®] 100-5 CN-RP particle size 5 µm, pore size 100 Å; eluent in column acetonitrile – water		
Analytical EC columns		
 4 mm	720205.40	721039.30
 4.6 mm	720205.46	721039.30
NUCLEOSIL[®] 100-10 CN particle size 10 µm, pore size 100 Å; eluent in column <i>n</i> -heptane		
Analytical EC columns		
 4 mm	720024.40	
 4.6 mm	720024.46	
NUCLEOSIL[®] 120-7 CN particle size 7 µm, pore size 120 Å; eluent in column <i>n</i> -heptane		
Analytical EC columns		
 4 mm	720057.40	
 4.6 mm	720057.46	



NUCLEOSIL® SA phases · USP L9

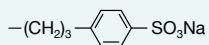



Technical data

• Strongly acidic cation exchanger (SCX) with benzenesulfonic acid modification

• Capacity ~ 1 meq/g; pH stability at 20 °C: 2–8; carbon content 6.5 %

Ordering information

Eluent in column 0.15 mol/L (NH₄)₂HPO₄, pH 5

ID	Length →				
	125 mm	150 mm	250 mm	EC guard columns*	
NUCLEOSIL® 100-5 SA particle size 5 µm, pore size 100 Å					
Analytical EC columns					
	4 mm			720097.40	721024.30
	4.6 mm	720709.46	720182.46	720097.46	721024.30
NUCLEOSIL® 100-10 SA particle size 10 µm, pore size 100 Å					
Analytical EC columns					
	4.6 mm			720028.46	

NUCLEOSIL® SB phases · USP L14

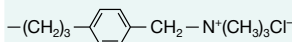



Technical data

• Strongly basic anion exchanger (SAX) with quaternary ammonium modification

• Capacity ~ 1 meq/g; pH stability at 20 °C: 2–8; carbon content 10 %

Ordering information

Eluent in column 0.15 mol/L (NH₄)₂HPO₄, pH 5

ID	Length →				
	125 mm	150 mm	250 mm	EC guard columns*	
NUCLEOSIL® 100-5 SB particle size 5 µm, pore size 100 Å					
Analytical EC columns					
	4 mm			720996.40	721025.30
	4.6 mm	720989.46	720183.46	720996.46	721025.30
NUCLEOSIL® 100-10 SB particle size 10 µm, pore size 100 Å					
Analytical EC columns					
	4.6 mm			720029.46	



NUCLEOSIL[®] SiOH unmodified silica · USP L3

Technical data

- Spherical silica, pH stability 2–8
- For physical properties of unmodified NUCLEOSIL[®] materials please see page 211.
- Maximum working pressure for the EC columns listed below is 400 bar.

Ordering information

Eluent in column is *n*-heptane. When using an eluent which is not miscible with *n*-heptane (e.g., water), it is necessary to rinse the column with THF first.

ID	Length → 250 mm	EC guard columns*
----	--------------------	-------------------

NUCLEOSIL[®] 50-5 particle size 5 μm, pore size 50 Å

Analytical EC columns

4.6 mm	720093.46	721167.30
--------	-----------	-----------

NUCLEOSIL[®] 100-5 particle size 5 μm, pore size 100 Å

Analytical EC columns

4.6 mm	720099.46	721518.30
--------	-----------	-----------

Guard column system

Guard columns for EC columns with ID	2 mm	3 mm	4 mm	4.6 mm	Guard column holder
* Column Protection System (pack of)	EC 4/2 (3)	4/3 (3)	4/3 (3)	4/3 (3)	718966

EC columns in packs of 1, guard columns in packs of 3. For details of our column systems see page 250.



Analytical columns with LiChrospher®



LiChrospher® packings manufactured by E. Merck (D)

Phase	USP	Particle size	Pore size	Modification	Endcapped	Carbon content
LiChrospher® 100 RP 18, 5 µm	L1	nom. 5 µm	100 Å	Octadecyl	–	21 %
LiChrospher® 100 RP 18 ec, 5 µm	L1	nom. 5 µm	100 Å	Octadecyl	+	21 %
LiChrospher® 60 RP select B, 5 µm	L7	nom. 5 µm	60 Å	Octyl	+	12 %

All phases as packed ChromCart® cartridges
 ChromCart® columns require the CC connecting kit (REF 721690).

Ordering information

Eluent in column acetonitrile – water

ID	Length →			
	125 mm	150 mm	250 mm	Guard columns*
LiChrospher® 100 RP 18, 5 µm particle size 5 µm, pore size 100 Å				
2 mm	728031.20		728032.20	728053.30
3 mm	728031.30		728032.30	728053.30
4 mm	728031.40		728032.40	728053.40
4.6 mm	728031.46	728033.46	728032.46	728053.40
LiChrospher® 100 RP 18 ec, 5 µm particle size 5 µm, pore size 100 Å				
2 mm	728034.20		728035.20	728054.30
3 mm	728034.30		728035.30	728054.30
4 mm	728034.40		728035.40	728054.40
4.6 mm	728034.46	728036.46	728035.46	728054.40
LiChrospher® 60 RP select B, 5 µm particle size 5 µm, pore size 100 Å				
2 mm	728037.20		728038.20	728055.30
3 mm	728037.30		728038.30	728055.30
4 mm	728037.40		728038.40	728055.40
4.6 mm	728037.46	728039.46	728038.46	728055.40

* can directly be used with the CC connecting kit (REF 721690).

8 mm ChromCart® guard column cartridges in packs of 3, all other columns in packs of 1.



Phase overview for special separations



Overview			
Separation / mechanism	Recommended column	Specification of the phase	Page
Environmental analysis			
Anion exchange chromatography of inorganic anions	NUCLEOGEL® Anion I	Strongly basic polymer-based anion exchanger	230
	NUCLEOSIL® Anion II	Strongly basic silica-based anion exchanger	
RP chromatography of PAHs	NUCLEODUR® C ₁₈ PAH	NUCLEODUR® polymer-coated with C ₁₈ groups USP L1	227
	NUCLEOSIL® 100-5 C ₁₈ PAH	NUCLEOSIL® 100 polymer-coated with C ₁₈ groups USP L1	229
Enantiomer separation			
Polar and π - π interactions	NUCLEOCEL DELTA	Silica-based modified cellulose phases USP L40	233
Formation of inclusion complexes	NUCLEODEX α -PM, β -PM, γ -PM and β -OH	Silica-based permethylated and underivatized cyclodextrin phases USP L45	231
Enantioselective binding to chiral protein surface structures	RESOLVOSIL BSA-7	Silica-based protein phase (BSA)	234
Ligand exchange	NUCLEOSIL® CHIRAL-1	Covalently bonded amino acid – Cu(II) complexes USP L32	235
Charge-transfer, dipole-dipole interactions and others	NUCLEOSIL® CHIRAL-2	Silica-based brush type phases USP L36	236
	NUCLEOSIL® CHIRAL-3		
Separation of biological macromolecules			
Anion exchange chromatography of oligonucleotides and nucleic acids	NUCLEOGEN® DEAE	Silica-based DEAE anion exchanger	237
Anion exchange chromatography of peptides, large proteins and oligonucleotides	NUCLEOGEL® SAX	Polymer-based strongly basic anion exchanger USP L23	240
Cation exchange chromatography of proteins, peptides and carbohydrates	NUCLEOGEL® SCX	Polymer-based strong cation exchanger USP L22	240
	NUCLEOSIL® MPN	Monomerically bonded alkyl chains on silica USP L1 / USP L26	243
Reversed phase chromatography of proteins, peptides and oligonucleotides	NUCLEOSIL® PPN	PolymERICALLY bonded alkyl chains on silica USP L1	244
	NUCLEOGEL® RP 300	Polystyrene – divinylbenzene polymer USP L21	245
Reversed phase chromatography of small molecules	NUCLEOGEL® RP 100	Small pore macroporous PS-DVB polymer USP L21	245
Food analysis · sugars			
RP chromatography of mono- and oligosaccharides	NUCLEOSIL® Carbohydrate	Silica-based special amino phase USP L8	246
Separation of sugars, alcohols, org. acids based on ion exclusion, ion exchange, size exclusion, ligand exchange, NP and RP effects	NUCLEOGEL® SUGAR 810 H, Ca	Resins with sulfonic acid modification in different ionic forms H form USP L17 / Ca form L19 / Pb form L34 / Na form L58	247
Separation of sugars, alcohols, org. acids based on steric exclusion, ligand exchange and partition effects	NUCLEOGEL® SUGAR Ca, Na, Pb NUCLEOGEL® ION 300 OA		248
Gel permeation chromatography (GPC)			
Water-insoluble compounds	NUCLEOGEL® GPC	Polystyrene – divinylbenzene polymer	249



NUCLEODUR® C₁₈ PAH special octadecyl phase for PAH analysis · USP L1

Technical data

• Base material NUCLEODUR® silica, particle sizes 1.8 and 3 µm, pore size 110 Å; polymeric coating

Recommended application

• Allows efficient gradient separation of the 16 PAHs according to EPA

Analysis of 16 EPA PAHs with or without acetonitrile

MN Appl. Nos. 123820/123830

Separation with acetonitrile

Column: 100 x 4 mm
NUCLEODUR® C₁₈ PAH, 3 µm
Eluent: A) methanol – water (80:20, v/v)
B) acetonitrile 2–20 % B in 1.2 min,
20–100 % B in 0.5 min, 100 % B
for 2.5 min, 100–2 % B in 0.4 min
Flow rate: 2.5 mL/min, temperature 35 °C
Detection: UV, 254 nm
fluorescence (see chromatogram)

Separation without acetonitrile

Column: 125 x 4 mm
NUCLEODUR® C₁₈ PAH, 3 µm
Eluent: A) water
B) methanol 65–97 % B in 6 min,
97 % B for 5 min, 97–65 % B in
0.5 min
Flow rate: 2 mL/min, temperature 35 °C
Detection: fluorescence (see chromatogram)

Peaks:

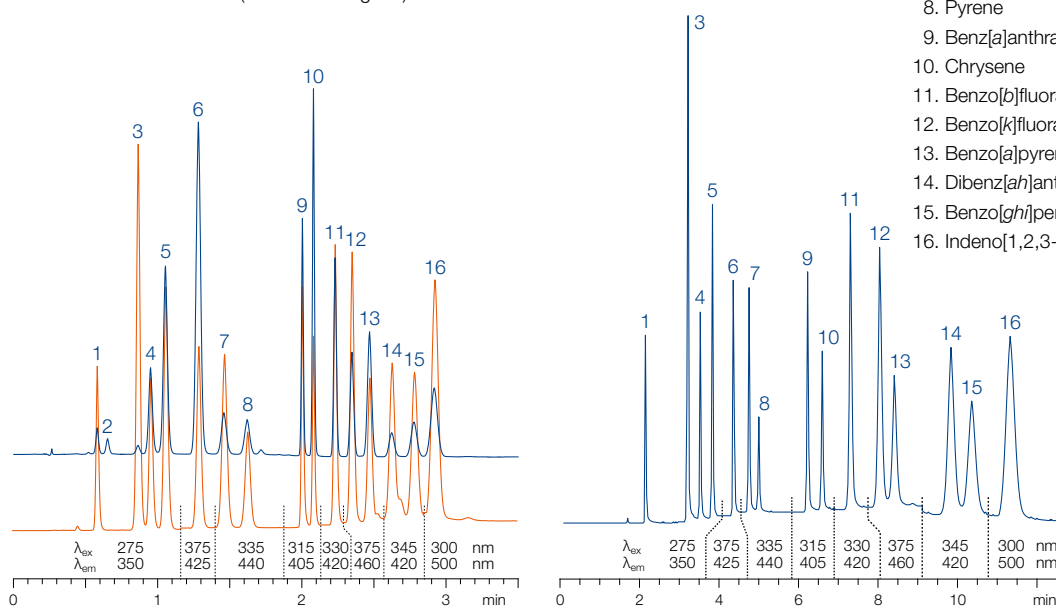

1. Naphthalene
2. Acenaphthylene (not detectable by fluorescence)
3. Acenaphthene
4. Fluorene
5. Phenanthrene
6. Anthracene
7. Fluoranthene
8. Pyrene
9. Benz[a]anthracene
10. Chrysene
11. Benzo[b]fluoranthene
12. Benzo[k]fluoranthene
13. Benzo[a]pyrene
14. Dibenzo[ah]anthracene
15. Benzo[ghi]perylene
16. Indeno[1,2,3-cd]pyrene



Detection of separated PAHs with UV (250–280 nm), diode array or fluorescence detection at different wavelengths for excitation and emission (acenaphthylene cannot be analyzed with fluorescence detection).

Ordering information

Eluent in column acetonitrile – water (70:30, v/v)

ID	Length →				EC guard columns*
	100 mm	125 mm	150 mm	250 mm	
NUCLEODUR® C₁₈ PAH, 1.8 µm particle size 1.8 µm · UHPLC					
Analytical EC columns					
	2 mm	760773.20			761970.20
	3 mm	760773.30			761970.30
	4 mm	760773.40			761970.30
NUCLEODUR® C₁₈ PAH, 3 µm particle size 3 µm					
Analytical EC columns					
	3 mm	760783.30	760784.30	760785.30	760786.30
	4 mm	760783.40	760784.40	760785.40	760786.40

Guard column system

Guard columns for EC columns with ID	2 mm	3 mm	4 mm	4.6 mm	Guard column holder
* Column Protection System (pack of)	EC	4/2 (3)	4/3 (3)	4/3 (3)	718966



Separation of 18 PAHs on NUCLEODUR® C₁₈ PAH

MN Appl. No. 123840

Column: 125 x 4 mm
NUCLEODUR® C₁₈ PAH, 3 µm

Eluent: A) methanol – water
(70:30, v/v); B) acetonitrile
0–20 % B in 1.5 min,
20–50 % B in 1.5 min,
50–100 % B in 1.0 min,
100 % B for 3 min,
100–0 % B in 0.5 min

Flow rate: 1.5 mL/min

Temperature: 35 °C

Injection: UV: 1 µL,
Fluorescence: 0.5 µL

Detection: UV, 254 nm
fluorescence
(see chromatogram)

Peaks:
(concentrations 10 ng/µL per compound)
1.–16. see page 227
1-me-n: 1-methylnaphthalene
2-me-n: 2-methylnaphthalene

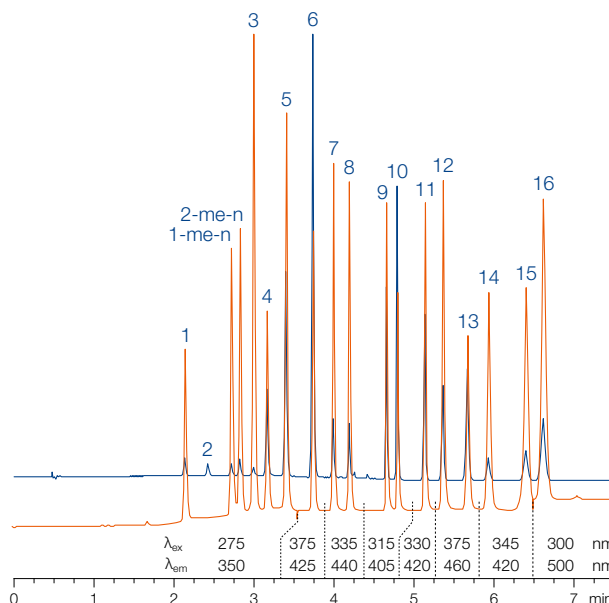

Analysis of polycyclic aromatic hydrocarbons (PAHs) by HPLC

Polycyclic aromatic hydrocarbons (PAHs) are chemical compounds that consist of fused aromatic rings and do not contain heteroatoms or carry substituents. As a pollutant, they are of concern because some compounds have been identified as carcinogenic, mutagenic, and teratogenic. PAHs are natural components of coal or gas. They are delivered to our environment by pyrolysis (incomplete burning) of organic materials like coal, oil, fuel, wood, tobacco, ... and hence can be found globally. Today most PAHs accrue from anthropogenic processes – but also natural origins (forest fire) are possible. Regarding to past pollutions an important impact had production of coke and gas from black coal. Waste products (e.g., tar) from coking or gas plants are often origin of serious ground water pollutions.

Since a number of PAHs (e.g., benzo[a]pyrene, 3-methylcholanthrene and benzantracene) have been proven to be carcinogenic, control of the PAH content of food, water and soil is an important task for routine analysis. For choice and limiting values of the polycyclics we refer to the governmental regulations, which exist in many countries (e.g., EPA method 610 of the United States Environmental Protection Agency).

PAHs can be determined by different chromatographic techniques (TLC, GC, HPLC). Thus the 6 PAHs according to German drinking water specification (TVO) can, e.g., be analyzed by TLC (see German Standard DIN 38 409), while a much larger number of polycyclic aromatics can be determined by GC or HPLC.

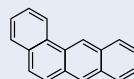

Benzo[a]anthracen

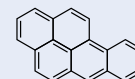

Benzo[a]pyren

HPLC columns for PAH analysis

For PAH analyses we have developed specially modified C₁₈ phases based on NUCLEODUR® and NUCLEOSIL® which allow efficient gradient separation of 16 PAHs according to EPA. Detection of the separated PAHs can be achieved by UV (250–280 nm), with diode array or with fluorescence detection at different wavelengths for excitation and emission. Acenaphthylene cannot be analyzed with fluorescence detection. For cost-effective routine PAH analysis we recommend applications using methanol instead of acetonitrile as eluent. For rapid analysis NUCLEODUR® C₁₈ PAH (3 µm) in short columns (100 mm) provides excellent results at high flow rates. Hereby separation of 16 PAHs according to EPA can be achieved in less than 3 min.

Tightened regulations require determination of 2 additional PAHs (1- and 2-methylnaphthalene) – so we developed highly efficient methods for 18 PAHs on the NUCLEODUR® C₁₈ PAH.



NUCLEOSIL® 100-5 C₁₈ PAH special octadecyl phase for PAH analysis · USP L1

Technical data

- Base material NUCLEOSIL® silica, particle size 5 µm, pore size 100 Å; polymeric coating
- Detection of the separated PAH with UV (250–280 nm), diode array or fluorescence detection at different wavelengths for excitation and emission (acenaphthylene cannot be analyzed with fluorescence detection)

Recommended application

- Efficient gradient separation of the 16 PAHs according to EPA

Separation of the PAH standard according to EPA (REF 722393)

MN Appl. No. 115040

Column: 150 x 4 mm NUCLEOSIL® 100-5 C₁₈ PAH
 Eluent: A) methanol – water (80:20)
 B) acetonitrile – tetrahydrofuran (93:7)
 0–100 % B in 10 min, 5 min 100 % B
 Flow rate: 1 mL/min
 Pressure: 140 bar
 Temperature: 20 °C
 Detection: UV, 260 nm

Peaks: (10 µg/mL each in acetonitrile)

- | | |
|----------------------|----------------------------|
| 1. Naphthalene | 10. Chrysene |
| 2. Acenaphthylene | 11. Benzo[b]fluoranthene |
| 3. Acenaphthene | 12. Benzo[k]fluoranthene |
| 4. Fluorene | 13. Benzo[a]pyrene |
| 5. Phenanthrene | 14. Dibenzo[ah]anthracene |
| 6. Anthracene | 15. Benzo[ghi]perylene |
| 7. Fluoranthene | 16. Indeno[1,2,3-cd]pyrene |
| 8. Pyrene | |
| 9. Benz[a]anthracene | |

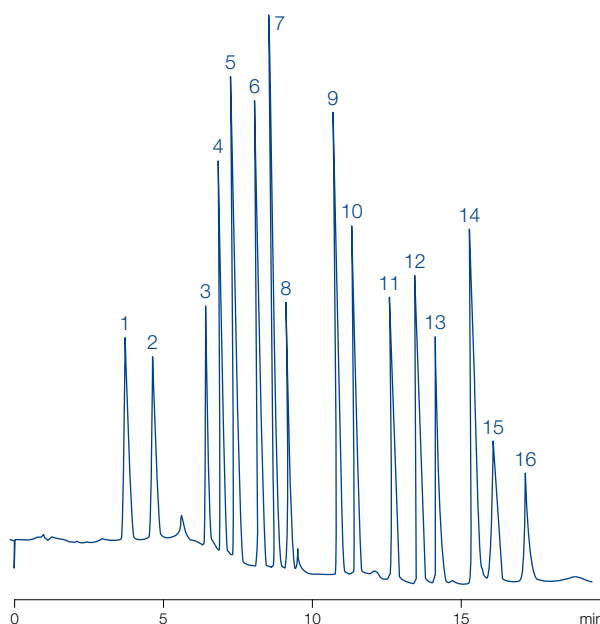

Ordering information

Eluent in column acetonitrile – water 70:30

ID	Length →		
	150 mm	250 mm	EC guard columns*
NUCLEOSIL® 100-5 C₁₈ PAH particle size 5 µm, pore size 100 Å			
Analytical EC columns			
	2 mm	720117.20	721168.20
	3 mm	720923.30	721168.30
	4 mm	720923.40	721168.30
	4.6 mm	720117.46	721168.30

PAH standard according to EPA for HPLC

Analytical EC columns		
PAH standard for HPLC	16 PAH according to EPA method 610 in acetonitrile (1 mL) for composition see chromatogram above	722393

Guard column system

Guard columns for EC columns with ID	2 mm	3 mm	4 mm	4.6 mm	Guard column holder
* Column Protection System (pack of)	EC 4/2 (3)	4/3 (3)	4/3 (3)	4/3 (3)	718966

EC columns in packs of 1, guard columns in packs of 3. For details of our column systems see page 250.

* This product contains harmful substances which must be specially labeled as hazardous. For detailed information please see SDS.



Anion columns for analysis of inorganic anions

NUCLEOGEL® Anion I

Technical data

- Strongly basic polymer-based anion exchanger, particle size 10 µm; pH stability 1–14
- Eluent in column 4 mmol/L salicylate buffer pH 7.8
- Contrary to the silica-based phase also suited for fluoride analysis

NUCLEOSIL® Anion II

Technical data

- Base material NUCLEOSIL® silica, particle size 10 µm, pore size 300 Å strongly basic anion exchanger, exchange capacity 50 µeq/g, pH stability 2–7.5
- Eluent in column 0.15 mol/L (NH₄)₂HPO₄ buffer pH 5.2 recommended buffer concentration for separation of inorganic anions: 2 mmol/L phthalate
- Preferred method of detection: conductivity or negative UV detection

Separation of an anion standard

MN Appl. No. 106440

Column: 250 x 4 mm NUCLEOSIL® Anion II
 Eluent: 2 mmol/L potassium hydrogen phthalate, pH 5.7
 Flow rate: 2 mL/min
 Detection: UV, 280 nm

- Peaks:
1. H₂PO₄⁻
 2. Cl⁻
 3. NO₂⁻
 4. NO₃⁻
 5. SO₄²⁻

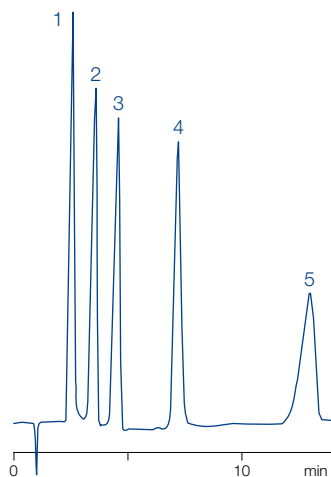

Separation of inorganic anions



MN Appl. No. 115050

Column: 120 x 4.6 mm NUCLEOGEL® Anion I
 Eluent: 4 mmol/L salicylic acid – Tris pH 7.8
 Flow rate: 1 mL/min
 Detection: UV, 254 nm

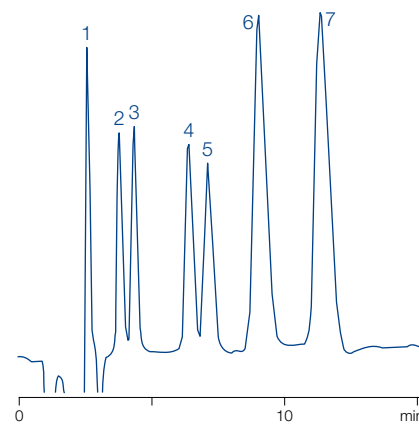
- Peaks:
1. F⁻
 2. Cl⁻
 3. NO₂⁻
 4. Br⁻
 5. NO₃⁻
 6. PO₄³⁻
 7. SO₄²⁻



Ordering information

ID	Length →		
	120 mm	250 mm	Guard columns*
NUCLEOGEL® Anion I eluent 4 mmol/L salicylate buffer pH 7.8			
Analytical Valco type columns			
 4.6 mm	719533		719543
NUCLEOSIL® Anion II eluent 0.15 mol/L (NH ₄) ₂ HPO ₄ buffer pH 5.2			
Analytical EC columns			
 4 mm		720094.40	721169.30

* NUCLEOGEL® Anion I Valco type guard columns cartridges are 21 x 4 mm, require guard column holder C, REF 719538, see page 250 (columns in packs of 1, guard columns in packs of 2)
 NUCLEOSIL® Anion II guard columns are used with the Column Protection System (REF 718966, see page 251).



NUCLEODEX columns enantiomer separation based on cyclodextrins

NUCLEODEX β -OH β -cyclodextrin (R = H; n = 2) · USP L45

Technical data

- Base material NUCLEOSIL[®] silica, particle size 5 μm , pore size 100 \AA modified cyclodextrins as chiral selectors
- Separation based on hydrogen bonds and dipole interactions between functional groups of the analyte and hydroxyl groups of the cyclodextrin
- Examples for successful enantiomer separations: chlorthalidone and other compounds, which require free hydroxyl groups for enantioselective interactions
- Eluent in column CH_3OH – 0.1 % TEAA pH 4 (55:45)

NUCLEODEX α -PM permethylated α -cyclodextrin (R = CH_3 ; n = 1)

Technical data

- Base material NUCLEOSIL[®] silica, particle size 5 μm , pore size 100 \AA modified cyclodextrins as chiral selectors
- Examples for successful enantiomer separations: mecoprop and dichlorprop as free carboxylic acids, trans-stilbene oxide, styrene oxide
- Eluent in column CH_3OH – 50 mmol/L phosphate pH 3 (70:30)

NUCLEODEX β -PM permethylated β -cyclodextrin (R = CH_3 ; n = 2) · USP L45

Technical data

- Base material NUCLEOSIL[®] silica, particle size 5 μm , pore size 100 \AA modified cyclodextrins as chiral selectors
- Examples for successful enantiomer separations: mephobarbital (prominal), pesticide derivatives mecoprop methyl and dichlorprop methyl
- Eluent in column CH_3OH – 0.1 % TEAA pH 4 (65:35)

NUCLEODEX γ -PM permethylated γ -cyclodextrin (R = CH_3 ; n = 3)

Technical data

- Base material NUCLEOSIL[®] silica, particle size 5 μm , pore size 100 \AA modified cyclodextrins as chiral selectors
- Examples for successful enantiomer separations: steroids or other larger molecules
- Eluent in column CH_3OH – 0.1 % TEAA pH 4 (55:45)

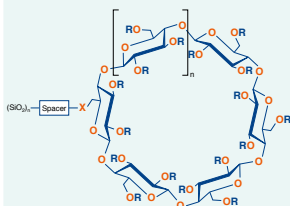

Recommended application

- NUCLEODEX phases are especially suited for the control of optical purity, but also for semipreparative separations and for the analysis of positional and cis-trans isomers.
- For numerous separations on NUCLEODEX phases please visit our website: www.mn-net.com/apps



HPLC columns for enantiomer separations



Separation of the positional isomers of nitroaniline

MN Appl. No. 101420

Column: 200 x 4 mm NUCLEODEX β-OH
 Eluent: methanol – 0.1 % triethylammonium acetate pH 4.0 (50:50, v/v)
 Flow rate: 0.7 mL/min
 Pressure: 180 bar
 Detection: UV, 254 nm
 Injection: 1 μL

- Peaks:
1. *m*-Nitroaniline
 2. *o*-Nitroaniline
 3. *p*-Nitroaniline

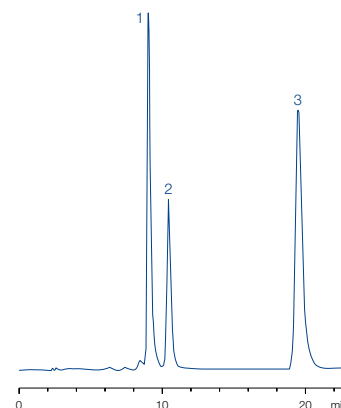

Enantiomer separation of styrene oxide

MN Appl. No. 106160

Column: 200 x 4 mm NUCLEODEX α-PM
 Eluent: methanol – 0.1 % triethylammonium acetate pH 4.0 (60:40, v/v)
 Flow rate: 0.7 mL/min
 Pressure: 160 bar
 Detection: UV, 230 nm
 Injection: 2 μL

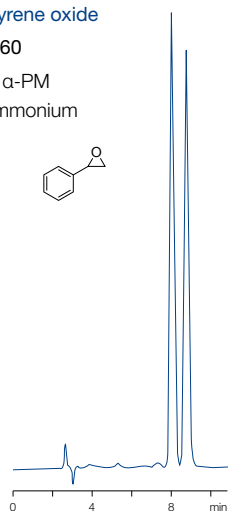



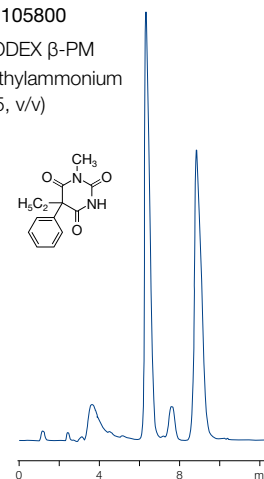
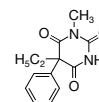

Enantiomer separation of mephobarbital

MN Appl. No. 105800

Column: 200 x 4 mm NUCLEODEX β-PM
 Eluent: methanol – 0.1 % triethylammonium acetate pH 4.0 (55:45, v/v)
 Flow rate: 0.7 mL/min
 Pressure: 180 bar
 Detection: UV, 254 nm
 Injection: 1 μL



Ordering information

ID	Length → 200 mm	EC guard columns*
NUCLEODEX β-OH eluent methanol – 0.1 % TEAA pH 4 (55:45)		
Analytical EC columns		
 4 mm	720124.40	721171.30
NUCLEODEX α-PM eluent methanol – 50 mmol/L phosphate pH 3 (70:30)		
Analytical EC columns		
 4 mm	720127.40	721469.30
NUCLEODEX β-PM eluent methanol – 0.1 % TEAA pH 4 (65:35)		
Analytical EC columns		
 4 mm	720125.40	721176.30
NUCLEODEX γ-PM eluent methanol – 0.1 % TEAA pH 4 (55:45)		
Analytical EC columns		
 4 mm	720752.40	721178.30

NUCLEODEX CC screening kit

contains one CC 30/4 each with NUCLEODEX β-OH, α-PM, β-PM and γ-PM as well as one CC column holder 30 mm

721920

* EC 4/3 guard columns for EC columns with 4 mm ID require the Column Protection System guard column holder (REF 718966, see page 251). Columns and guard columns in packs of 1.



NUCLEOCEL DELTA enantiomer separation based on a cellulose derivative · USP L40

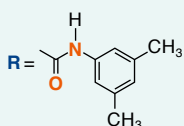
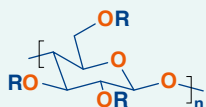

Technical data

- Base material silica, chiral selector cellulose tris-(3,5-dimethylphenylcarbamate)
- High resolution type (S) with 5 µm particle size, allows use of shorter columns (150 mm) for faster separations, pressure stability up to ~150 bar (2000 psi), pH stability 1–9

NUCLEOCEL DELTA for normal phase applications: eluent in column *n*-heptane – 2-propanol (90:10, v/v) typical eluents are heptane – propanol mixtures

NUCLEOCEL DELTA-RP for reversed phase applications: eluent in column acetonitrile – water (40:60, v/v) designed for use either in polar organic mode or with eluents containing high concentrations of chaotropic salts such as perchlorate

Recommended application

- Pharmaceutically active compounds, chiral pollutants (e.g., herbicides, PCB), chiral compounds in food (dyes, preservatives), chiral catalysts and bioorganic compounds

Similar phases: Chiralcel® OD, Kromasil® CelluCoat™, Eurocel® 01, Lux™ Cellulose-1

Enantiomer separation of indapamide

MN Appl. No. 121230

Column: 250 x 4,6 mm NUCLEOCEL DELTA-RP S
 Eluent: acetonitrile – water (40:60, v/v)
 Flow rate: 0.5 mL/min
 Temperature: 40 °C
 Detection: UV, 254 nm
 Injection: 5 µL
 Concentration: 1 µg/µL

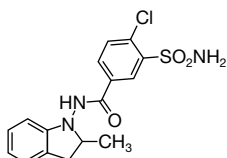

$\alpha = 1.3$
 $R_s = 2.6$

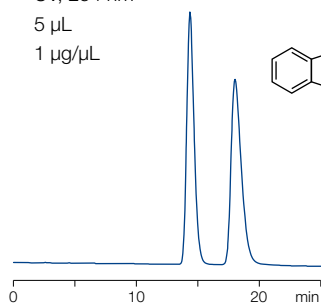

Enantiomer separation of flavanone

MN Appl. No. 121260

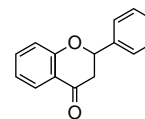

Column: 250 x 4,6 mm NUCLEOCEL DELTA S
 Eluent: *n*-heptane – 2-propanol (90:10, v/v)
 Flow rate: 1 mL/min
 Temperature: 25 °C
 Detection: UV, 254 nm
 Injection: 5 µL
 Concentration: 1 µg/µL

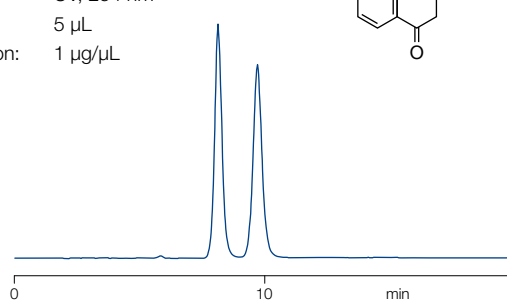

$\alpha = 1.29$
 $R_s = 2.6$



Ordering information

ID	Length → 150 mm	250 mm		EC guard columns*
NUCLEOCEL DELTA S, 5 µm eluent <i>n</i> -heptane – 2-propanol (90:10, v/v)				
Analytical EC columns				
 4.6 mm		720445.46		721185.30
NUCLEOCEL DELTA-RP S, 5 µm eluent acetonitrile – water (40:60, v/v)				
Analytical EC columns				
 4.6 mm	720451.46	720450.46		721186.30

* EC 4/3 guard column cartridges are used for EC columns of 4.6 mm ID with the Column Protection System guard column holder (REF 718966, see page 251). Columns and guard columns in packs of 1.



RESOLVOSIL BSA-7 protein phase for enantiomer separation · USP L75

Technical data

- Base material NUCLEOSIL® silica, particle size 7 µm, pore size 300 Å chiral selector bovine serum albumin (BSA)
- Separation based on selective interaction of proteins with low molecular compounds, i.e. principles of bioaffinity, including hydrophobic interactions (similar to a true reversed phase), interactions of polar groups and steric effects

Recommended application

- Amino acid derivatives, aromatic amino acids, aromatic sulfoxides, barbiturates, benzodiazepinones, benzoin and benzoin derivatives, β-blockers, coumarin derivatives, and for monitoring stereoselective microbial and enzymatic conversions

Enantiomer separation of *N*-benzoyl-*D,L*-amino acids

MN Appl. No. 105450

S. Allenmark et al. in "Affinity chromatography and biological recognition" (I. Chaiken, M. Wilchek, and I. Parikh. Eds.), Academic Press, New York, 1983, 259–260

Column: 150 x 4 mm RESOLVOSIL BSA-7
 Eluent: 50 mmol/L phosphate buffer pH 6.5
 + 1 % 1-propanol
 Flow rate: 0.70 mL/min
 Detection: UV, 225 nm

- Peaks:
1. Serine
 2. Alanine
 3. Phenylalanine

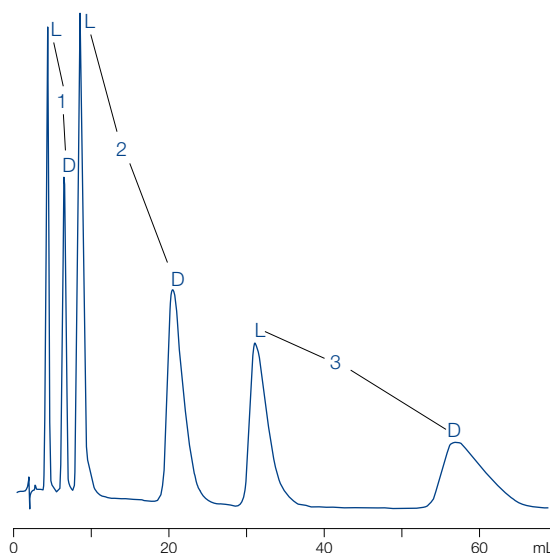

Ordering information

Eluent in column 0.1 mol/L phosphate buffer pH 7.5, 2 % 1-propanol

ID	Length → 150 mm	EC guard columns*
----	--------------------	-------------------

RESOLVOSIL BSA-7

Analytical EC columns



4 mm

720046.40

721402.30

* EC 4/3 guard columns for EC columns with 4 mm ID require the Column Protection System guard column holder (REF 718966, see page 251). Columns and guard columns in packs of 1.



NUCLEOSIL® CHIRAL-1 enantiomer separation based on ligand exchange · USP L32

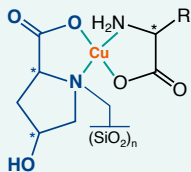

🔧 Technical data

- Base material NUCLEOSIL® silica, particle size 5 µm, pore size 120 Å chiral selector L-hydroxyproline – Cu²⁺ complexes
- Principal interaction mode:
 - formation of ternary mixed-ligand complexes with Cu(II) ions; differences in the stability of the diastereomeric complexes cause chromatographic separation

✓ Recommended application

- Enantiomers with two polar functional groups with the correct spacing such as α-amino acids, α-hydroxycarboxylic acids (e.g., lactic acid), *N*-alkyl-α-amino acids etc.

D,L-alanine enantiomers

MN Appl. No. 105410

Column: 250 x 4 mm NUCLEOSIL® CHIRAL-1
 Eluent: 0.5 mmol/L CuSO₄
 Flow rate: 1 mL/min
 Pressure: 60 bar
 Temperature: 60 °C
 Detection: UV, 250 nm

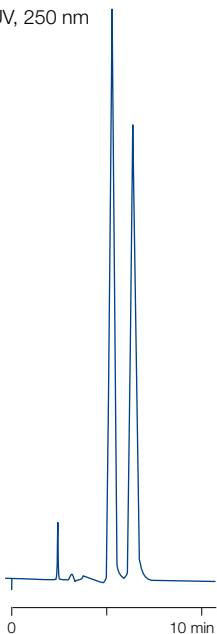

D,L-threonine enantiomers

MN Appl. No. 105410

Column: 250 x 4 mm NUCLEOSIL® CHIRAL-1
 Eluent: 0.25 mmol/L CuSO₄
 Flow rate: 0.8 mL/min
 Pressure: 65 bar
 Temperature: 60 °C
 Detection: UV, 240 nm

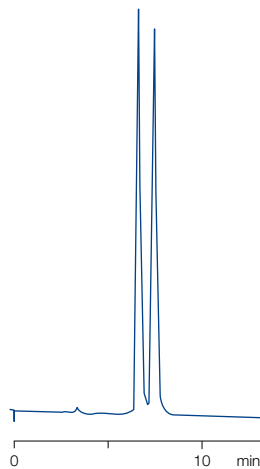

Lactic acid enantiomers

MN Appl. No. 105560

Column: 250 x 4 mm NUCLEOSIL® CHIRAL-1
 Eluent: 0.5 mmol/L CuSO₄
 Flow rate: 0.8 mL/min
 Temperature: 60 °C
 Detection: UV, 240 nm
 Injection: 1 µL

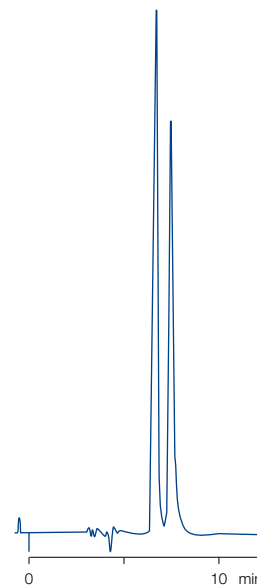

Ordering information

Eluent in column 0.5 mmol/L copper sulfate solution

ID

Length →

250 mm

EC guard columns*

NUCLEOSIL® CHIRAL-1

Analytical EC columns



4 mm

720081.40

721188.30

* EC 4/3 guard columns for EC columns with 4 mm ID require the Column Protection System guard column holder (REF 718966, see page 251). Columns and guard columns in packs of 1.



NUCLEOSIL® CHIRAL-2 · CHIRAL-3 enantiomer separation in organic eluent systems · USP L36

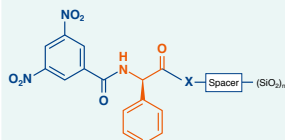

Technical data

- Base material NUCLEOSIL® silica, particle size 5 µm, pore size 100 Å chiral selector for NUCLEOSIL® CHIRAL-2 is *N*-(3,5-dinitrobenzoyl)-*D*-phenylglycine, for CHIRAL-3 the optical antipode is used, “brush type” phases
- Principle interaction modes: charge-transfer interactions, hydrogen bonds, dipole-dipole interactions and steric effects

Recommended application

- analysis of stereoisomers such as separation of enantiomers and diastereomers, control of optical purity of plant protectives (pesticides, e.g., propionic acid derived herbicides) pharmaceuticals etc. and for product control in chiral organic syntheses
- For control of optical purity of a substance, the columns NUCLEOSIL® CHIRAL-2 and NUCLEOSIL® CHIRAL-3 allow to select conditions such that the minor enantiomer, present as an impurity, is eluted before the main peak. Overlapping peaks are avoided. This makes an exact quantification of the impurity much easier.

Enantiomer separation of *D,L*-supidimide

MN Appl. No. 105690

Column: 250 x 4 mm NUCLEOSIL® CHIRAL-2
 Eluent: tetrahydrofuran – *n*-heptane (10:3, v/v)
 Flow rate: 1.0 mL/min
 Detection: UV, 220 nm

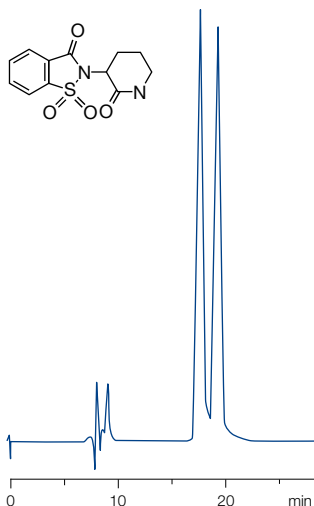

Control of optical purity of mecoprop methyl

MN Appl. No. 111360

Columns: a) 250 x 4 mm NUCLEOSIL® CHIRAL-2
 b) 250 x 4 mm NUCLEOSIL® CHIRAL-3
 Eluent: *n*-heptane – 2-propanol – TFA (100:0.05:0.05, v/v/v)
 Flow rate: 1 mL/min, ambient temperature
 Detection: UV, 230 nm, Injection 1 µL (sample with 90 % ee)

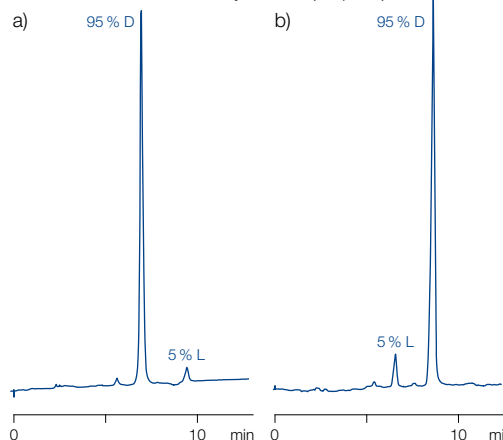

Ordering information

Eluent in column *n*-heptane – 2-propanol – TFAA (100:0.05:0.05, v/v/v)

ID	Length → 250 mm	EC guard columns*
NUCLEOSIL® CHIRAL-2		
Analytical EC columns		
4 mm	720088.40	721190.30
NUCLEOSIL® CHIRAL-3		
Analytical EC columns		
4 mm	720350.40	721190.30

Guard columns for NUCLEOSIL® CHIRAL-2 and CHIRAL-3 are identical.

* EC 4/3 guard columns for EC columns with 4 mm ID require the Column Protection System guard column holder (REF 718966, see page 251). EC columns and EC guard columns in packs of 1.



NUCLEOGEN® columns anion exchange chromatography of nucleic acids

NUCLEOGEN® 60-7 DEAE pore size 60 Å

Technical data

- Base material silica, particle size 7 µm; DEAE anion exchanger
- For the separation of oligonucleotides up to chain lengths of 40 bases with recoveries > 95 % capacity 200 A₂₆₀/mL (~ 300 A₂₆₀ for a 125 x 4 mm ID column, 1875 A₂₆₀ for a 125 x 10 mm ID column)
- Preparative separations possible when using higher flow rates and longer gradient times

NUCLEOGEN® 500-7 DEAE pore size 500 Å

Technical data

- Base material silica, particle size 7 µm; DEAE anion exchanger
- For the separation of tRNA, 5S RNA, viroids and messenger RNA in the intermediate molecular weight range (25–1 000 kDa) with recoveries > 95 %
- Capacity 730 A₂₆₀ for a 125 x 6 mm ID column, 1940 A₂₆₀ for a 125 x 10 mm ID column

NUCLEOGEN® 4000-7 DEAE pore size 4000 Å

Technical data

- Base material silica, particle size 7 µm; DEAE anion exchanger
- For the separation of plasmids, DNA restriction fragments, ribosomal RNA, messenger RNA and viral RNA, i.e. very high molecular weight nucleic acids (e.g., 1–50 MDa)
- Capacity 120 A₂₆₀ for a 125 x 6 mm ID column, 350 A₂₆₀ for a 125 x 10 mm ID column

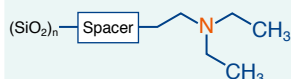

For more separations of deoxyoligonucleotides, plasmids and DNA restriction fragments visit our website www.mn-net.com/apps

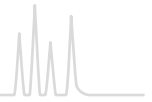

Separation of plasmid pBR 322

MN Appl. No. 107480

M. Colpan, D. Riesner, private communication

A) isolation of plasmid DNA from a crude cell lysate

Sample: 5 µg plasmid pBR 322 containing cleared lysate from *E. coli*

Column: 125 x 6 mm NUCLEOGEN® 4000-7 DEAE

Eluent: A) 20 mmol/L K phosphate buffer pH 6.9; 5 mol/L urea
B) eluent A + 1.5 mol/L KCl
20–100 % B in 50 min;
arrow = ionic strength of 850 mmol/L

Flow rate: 1.0 mL/min, 70 bar, ambient temperature

Detection: UV, 260 nm

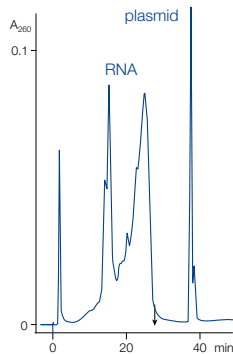

B) separation of supercoiled plasmid from relaxed and linear forms

Sample: plasmid pBR 322, supercoiled, relaxed and linear

Column: 125 x 6 mm NUCLEOGEN® 4000-7 DEAE

Eluent: A) 20 mmol/L K phosphate buffer pH 6.8; 6 mol/L urea
B) eluent A + 2 mol/L KCl
42–100 % B in 230 min

Flow rate: 1.5 mL/min, 45 bar, ambient temperature

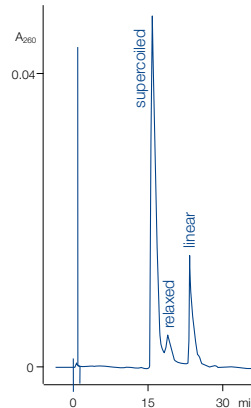

Separation of oligo(rA)_n

MN Appl. No. 115180

Column: 125 x 4 mm NUCLEOGEN® 60-7 DEAE

Eluent: A) 20 mmol/L phosphate buffer, pH 5.5, 5 mol/L urea
B) buffer A + 1 mol/L KCl
0–100 % B in 200 min

Flow rate: 2 mL/min

Pressure: 110 bar

Temperature: ambient

Detection: UV, 260 nm

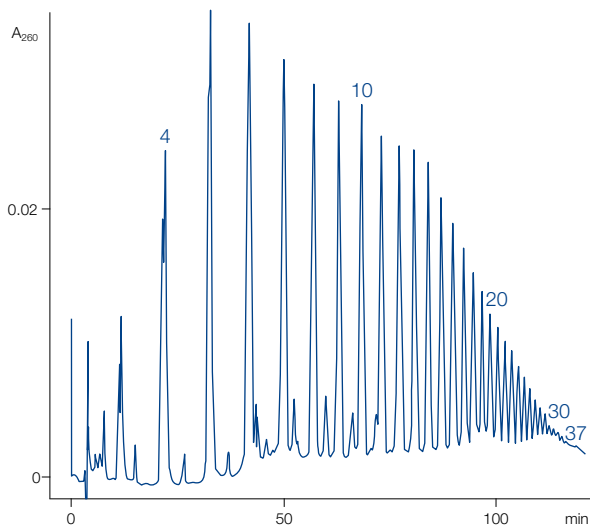

Preparative separation of a crude RNA extract of viroid (PSTV) infected tomato plants

MN Appl. No. 107490

D. Riesner, BioEngineering 1 (1988) 42–48

Column: 125 x 6 mm NUCLEOGEN® 500-7 DEAE

Eluent: A) 250 mmol/L KCl, 20 mmol/L phosphate buffer, pH 6.6, 5 mol/L urea
B) 1 mol/L KCl, 20 mmol/L phosphate buffer, pH 6.6, 5 mol/L urea
0–50 % B in 120 min, 50–100 % B in 250 min

Flow rate: 3 mL/min

Pressure: 40 bar, ambient temperature

Detection: 260 nm

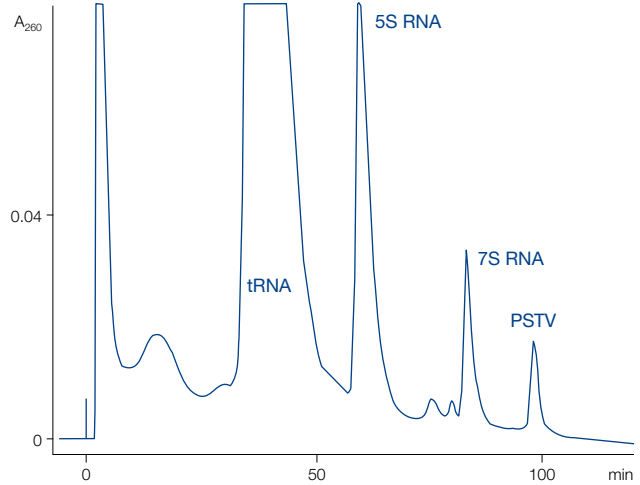









HPLC columns for biochemical separations



Ordering information

Eluent in column methanol

ID	Length → 125 mm	Guard columns*
NUCLEOGEN® 60-7 DEAE particle size 7 µm, pore size 60 Å		
Analytical EC columns		
 4 mm	736596.40	736400.40
Preparative VarioPrep columns		
 10 mm	736597.100	736400.40
NUCLEOGEN® 500-7 DEAE particle size 7 µm, pore size 500 Å		
Analytical Valco type columns		
 6 mm	736598	736400.40
Preparative VarioPrep columns		
 10 mm	736599.100	736400.40
NUCLEOGEN® 4000-7 DEAE particle size 7 µm, pore size 4000 Å		
Analytical Valco type columns		
 6 mm	736601	736400.40
Preparative VarioPrep columns		
 10 mm	736602.100	736400.40

* NUCLEOGEN® guard columns are 30 mm long and require the CC column holder 30 mm (REF 721823).
Columns in packs of 1, guard columns in packs of 2.



NUCLEOGEL® SAX anion exchange of biological macromolecules · USP L23

Technical data

- Polymer-based strongly basic anion exchanger $-N^+(CH_3)_3$, gel matrix quaternized PEI; particle size 8 μm , pore size 1000 \AA
- pH working range 1–13, max. working pressure 200 bar

Recommended application

- Purification of peptides, large proteins and oligonucleotides, high capacity for proteins even at pH 10

NUCLEOGEL® SCX cation exchange of biological macromolecules · USP L22

Technical data

- Polymer-based strongly acidic cation exchanger $-SO_3^-$, hydrophilic gel matrix; particle size 8 μm , pore size 1000 \AA
- pH working range 1–13, max. working pressure 200 bar

Recommended application

- Proteins, peptides and carbohydrates with high isoelectric point

Separation of hen's egg white

MN Appl. No. 115200

Sample: frozen egg white was thawed, filtered and diluted 1:8 with eluent A
 Column: 50 x 4.6 mm NUCLEOGEL® SAX 1000-8
 Eluent: A) 0.01 mol/L Tris-HCl, pH 7.5; B) A + 0.5 mol/L NaAc, pH 7.5; 0–100 % B in 20 min
 Flow rate: 1 mL/min
 Inj. volumen: 50 μL
 Detection: UV, 280 nm

- Peaks:
1. Conalbumin
 2. Ovalbumin
 3. not identified

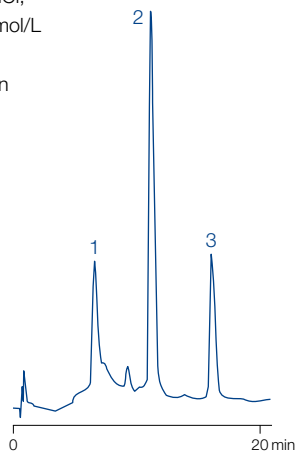

Separation of protein standards

MN Appl. No. 108261

Column: 50 x 4.6 mm NUCLEOGEL® SCX 1000-8
 Eluent: A) 0.02 mol/L KH_2PO_4 , pH 6.0
 B) A + 0,5 mol/L NaCl, pH 6.0
 0–100 % B in 20 min
 Flow rate: 1 mL/min
 Detection: UV, 280 nm

- Peaks:
1. Myoglobin
 2. α -Chymotrypsinogen A
 3. Cytochrome C
 4. Lysozyme

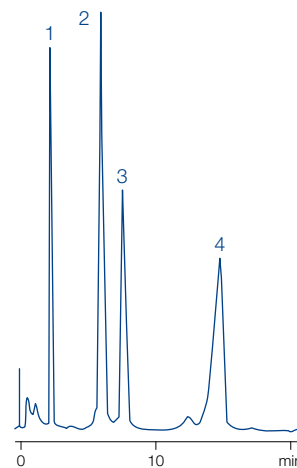

Ordering information

Eluent in column 0.1 mol/L Na_2SO_4 + 0.2 % NaN_3

ID

Length →
50 mm

Guard columns*

NUCLEOGEL® SAX pore size 1000 \AA

Analytical Valco type columns



4.6 mm

719469

719600

NUCLEOGEL® SCX pore size 1000 \AA

Analytical Valco type columns



4.6 mm

719475

719540

* NUCLEOGEL® SAX and SCX Valco type guard columns measure 5 x 3 mm and require the guard column holder B, REF 719539 (see page 250)
 Columns in packs of 1, guard columns in packs of 2.



NUCLEODUR® 300 C₁₈ ec · C₄ ec wide pore silica for biochromatography · USP L1 (C₁₈) · USP L26 (C₄)

★ Key feature

- Reliable wide pore RP phases for daily routine analysis
- Medium density octadecyl or butyl modification with exhaustive endcapping
- Ideal phases for separation of biomolecules

🔧 Technical data

- Pore size 300 Å; particle size 5 µm, carbon content 4 % for C₁₈, 2.5 % for C₄; pH stability 1–9; high reproducibility from lot to lot

✓ Recommended application

- Biological macromolecules like proteins or peptides

Column selection by analyte characteristics

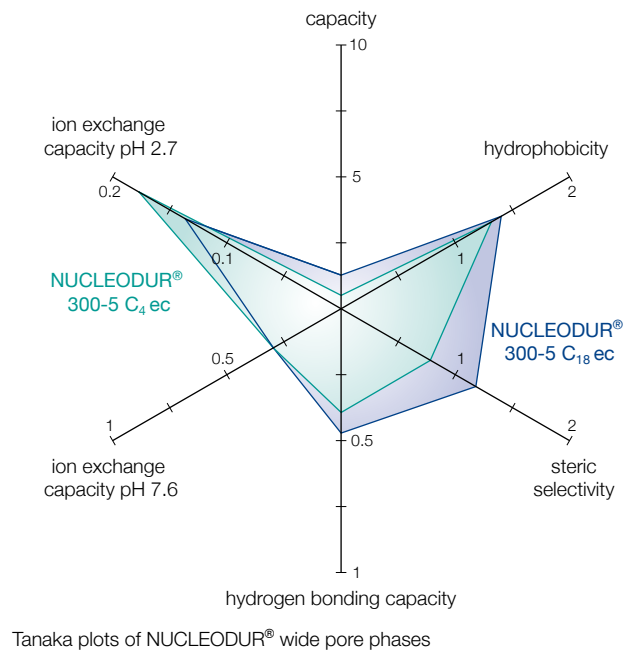
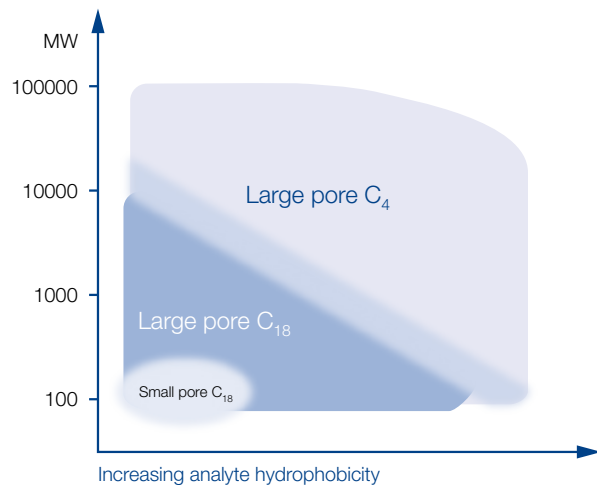

Batch-to-batch reproducibility of NUCLEODUR® 300-5 C₄ ec and NUCLEODUR® 300-5 C₁₈ ec

MN Appl. Nos. 126551 / 126552

Columns: 250 x 4 mm
 Eluent: A) 0.1 % TFA in water
 B) 0.08 % TFA in acetonitrile
 20–60 % B in 15 min
 Flow rate: 1 mL/min
 Temperature: 25 °C
 Detection: UV, 280 nm

Peaks:
 1. Ribonuclease A
 2. Cytochrome C
 3. Lysozyme
 4. BSA
 5. β-Lactoglobulin
 6. β-Lactoglobulin 2

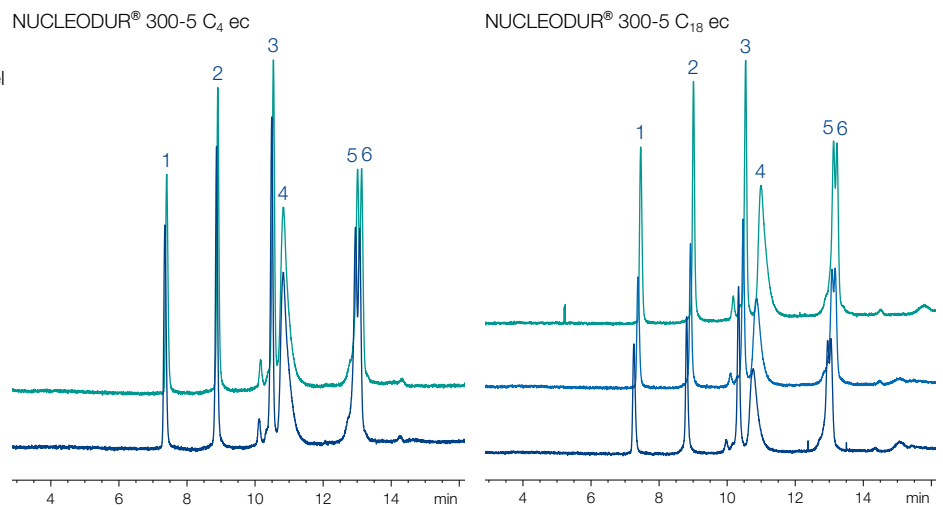



HPLC columns for biochemical separations

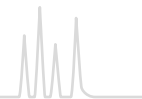

Comparison of narrow and wide pore NUCLEODUR® for the separation of proteins

MN Appl. No. 126590

Columns: 250 x 4,6 mm NUCLEODUR® 300-5 C₁₈ ec
250 x 4,6 mm NUCLEODUR® C₁₈ Gravity, 5 µm

Eluent: A) 0.1 % TFA in water
B) 0.08 % TFA in acetonitrile
20–65 % B in 15 min
(3 min 65 % B)

Flow rate: 1.3 mL/min
Temperature: 25 °C
Detection: UV, 280 nm

Peaks:

1. Ribonuclease A
2. Cytochrome C
3. Lysozyme
4. BSA
5. β-Lactoglobulin
6. β-Lactoglobulin 2

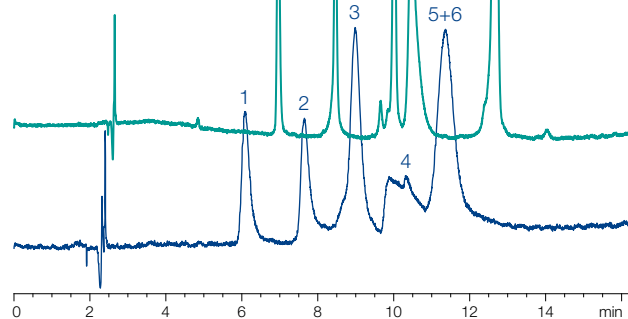

Sharper peaks of larger molecules on wide pore material

Tryptic digest of cytochrome C

MN Appl. No. 126600

Columns: 250 x 4.6 mm NUCLEODUR® 300-5 C₁₈ ec
250 x 4.6 mm Jupiter® C₁₈, 5 µm

Eluent: A) 0.1 % TFA in water
B) 0.08 % TFA in acetonitrile
5–40 % B in 15 min (1 min 40 % B)

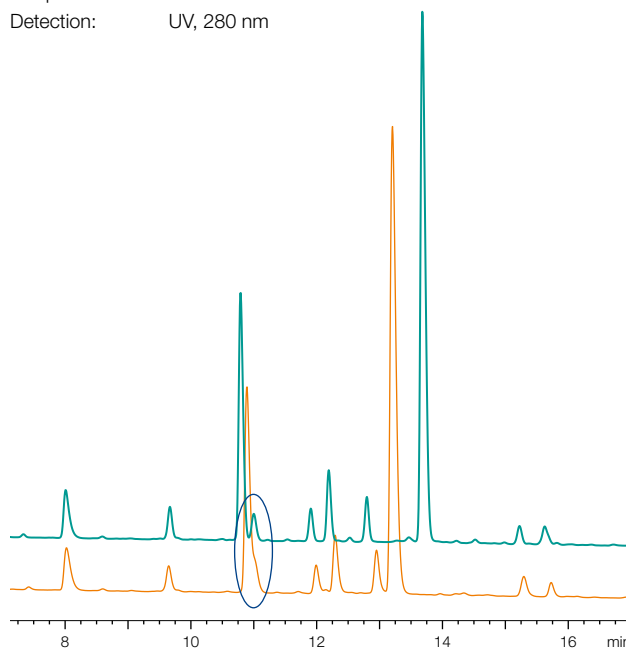

Flow rate: 1.3 mL/min
Temperature: 30 °C
Detection: UV, 280 nm



Less tailing and better separation on NUCLEODUR® 300 C₁₈ ec

Ordering information

Eluent in column acetonitrile – water

ID	Length →					EC guard columns*
	100 mm	125 mm	150 mm	250 mm		
NUCLEODUR® 300-5 C₁₈ ec octadecyl phase, particle size 5 µm, pore size 300 Å, endcapped, 4 % C						
Analytical EC columns						
	2 mm	760183.20	760184.20	760185.20	760186.20	761988.20
	3 mm	760183.30	760184.30	760185.30	760186.30	761988.30
	4 mm	760183.40	760184.40	760185.40	760186.40	761988.30
	4.6 mm	760183.46	760184.46	760185.46	760186.46	761988.30
NUCLEODUR® 300-5 C₄ ec butyl phase, particle size 5 µm, pore size 300 Å, endcapped, 2.5 % C						
Analytical EC columns						
	2 mm	760193.20	760194.20	760195.20	760196.20	761989.20
	3 mm	760193.30	760194.30	760195.30	760196.30	761989.30
	4 mm	760193.40	760194.40	760195.40	760196.40	761989.30
	4.6 mm	760193.46	760194.46	760195.46	760196.46	761989.30

* EC guard columns require the Column Protection System guard column holder (REF 718966, see page 251).

EC columns in packs of 1, guard columns in packs of 3.



NUCLEOSIL® MPN RP chromatography of biological macromolecules

NUCLEOSIL® 100-5 C₁₈ MPN · USP L1

★ Key feature

- Octadecyl phase, particle size 5 µm; pore size 100 Å
- Dynamic protein binding capacity per g packing: 6 mg BSA, 110 mg cytochrome C
- pH working range 2–8, max. working pressure 250 bar

🔧 Technical data

- Silica-based reversed phase materials with monomerically bonded alkyl chains, brush type structure predominantly hydrophobic forces with a small portion of hydrophilic interactions
- Maximum separation efficiency can be achieved when the injected protein mass does not exceed 1–2 % of the maximum protein loading capacity.

NUCLEOSIL® 300-5 C₄ MPN · USP L26

★ Key feature

- Butyl phase, particle size 5 µm, pore size 300 Å
- Dynamic protein binding capacity per g packing: 14 mg BSA, 27 mg cytochrome C especially suited for the purification of larger, hydrophobic peptides and very different proteins
- pH working range 2–8, max. working pressure 250 bar

🔧 Technical data

- Silica-based reversed phase materials with monomerically bonded alkyl chains, brush type structure predominantly hydrophobic forces with a small portion of hydrophilic interactions
- Maximum separation efficiency can be achieved when the injected protein mass does not exceed 1–2 % of the maximum protein loading capacity.

Separation of haemoglobin chains

MN Appl. No. 108240

Column: 250 x 4 mm NUCLEOSIL® 300-5 C₄ MPN
 Eluent: A) 20 % acetonitrile, 80 % water, 0.1 % TFA
 B) 60 % acetonitrile, 40 % water, 0.1 % TFA
 40–60 % B in 60 min
 Flow rate: 1 mL/min
 Detection: UV, 220 nm

- Peaks:
1. Hem
 2. β-globin
 3. α-globin
 4. ^Δγ^T-globin
 5. ^εγ-globin
 6. ^Δγ^L-globin

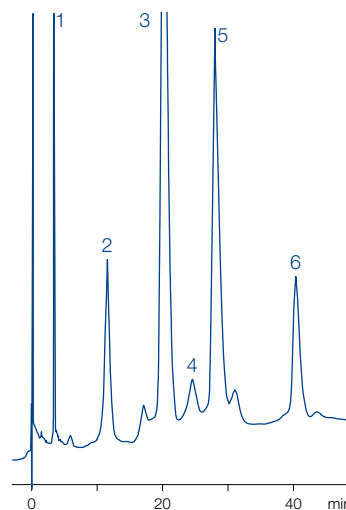

Ordering information

Eluent in column methanol

ID	Length → 250 mm	EC guard columns*
----	--------------------	-------------------

NUCLEOSIL® 100-5 C₁₈ MPN

Analytical EC columns

	4 mm	720231.40
---	------	-----------

NUCLEOSIL® 300-5 C₄ MPN

Analytical EC columns

	4 mm	720245.40	721119.30
---	------	-----------	-----------

* EC guard columns require the Column Protection System guard column holder (REF 718966, see page 251). Columns in packs of 1, guard columns in packs of 2.



NUCLEOSIL® PPN RP chromatography of biological macromolecules

NUCLEOSIL® 100-5 C₁₈ PPN · USP L1

★ Key feature

- Octadecyl phase, particle size 5 µm, pore size 100 Å, dynamic protein binding capacity per g packing: 8 mg BSA, 64 mg cytochrome C; suited for the separation of peptides and proteins up to about 40 kD, also suited for basic peptides

🔧 Technical data

- Silica-based reversed phase materials with polymerically bonded alkyl chains; exclusively hydrophobic interactions
- pH working range 1–9, max. working pressure 250 bar

NUCLEOSIL® 500-5 C₁₈ PPN · USP L1

★ Key feature

- Octadecyl phase, particle size 5 µm, pore size 500 Å, dynamic protein binding capacity per g packing: 22 mg BSA, 40 mg cytochrome C; especially suited for large peptides and medium-size hydrophilic proteins

🔧 Technical data

- Silica-based reversed phase materials with polymerically bonded alkyl chains; exclusively hydrophobic interactions
- pH working range 1–9, max. working pressure 250 bar

Separation of a protein standard

MN Appl. No. 108220

Column: 125 x 4 mm NUCLEOSIL® 100-5 C₁₈ PPN

Eluent: A) 0.1 % TFA in H₂O
B) 0.08 % TFA in CH₃CN
20–60 % B in 10 min

Flow rate: 1.0 mL/min

Detection: UV, 280 nm

Peaks:

1. Ribonuclease
2. Cytochrome C
3. Lysozyme
4. β-Lactoglobulin
5. Ovalbumin

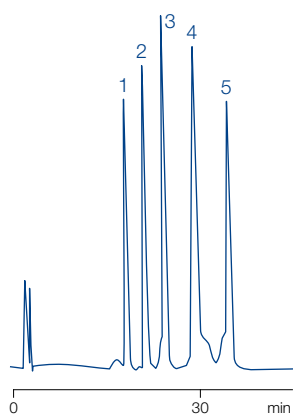

Separation of pancreatic secretion of piglets

MN Appl. No. 108280

Column: 125 x 4 mm NUCLEOSIL® 500-5 C₁₈ PPN

Eluent: A) 0.1 % TFA in H₂O
B) 0.08 % TFA in CH₃CN
30–50 % B in 14 min, then 50–65 % B in 6 min

Flow rate: 1 mL/min

Detection: UV, 215 nm

Peaks:

1. Trypsin + trypsinogen
2. Proelastase
3. Lipase + α-Chymotrypsin
4. Chymotrypsinogen
5. α-Amylase
- 6., 7. Procarboxypeptidase

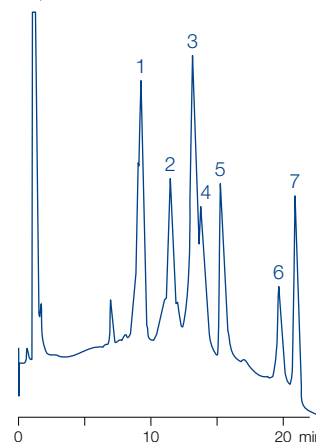

Ordering information

Eluent in column methanol

ID	Length → 250 mm	EC guard columns*
NUCLEOSIL® 100-5 C₁₈ PPN particle size 5 µm, pore size 100 Å		
Analytical EC columns		
4 mm	720252.40	721567.30
NUCLEOSIL® 500-5 C₁₈ PPN particle size 5 µm, pore size 500 Å		
Analytical EC columns		
4 mm	720258.40	721924.30

* EC guard columns require the Column Protection System guard column holder (REF 718966, see page 251).

Columns in packs of 1, guard columns in packs of 2.

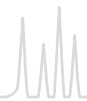

NUCLEOGEL® RP columns RP columns for biochemical applications · USP L21

Technical data

- Polystyrene resin cross-linked with divinylbenzene, available particle sizes 5 µm and 8 µm, available pore sizes 100 Å and 300 Å
- pH working range 1–13, max. working pressure 180 bar
- Small pore columns for reversed phase separation of small molecules such as pharmaceuticals with basic properties, e.g., organic heterocycles; also suited for separation of nucleosides and nucleotides up to 5000 Da; allow gradient as well as isocratic elution
- Wide pore columns are especially recommended for large biomolecules higher background hydrophobicity compared to silica phases

Analysis of the synthetic acyl carrier protein ACP(65-74)

MN Appl. No. 108500

Column: 150 x 4.6 mm NUCLEOGEL® RP 100-8
 Eluant: A) 0.1 % TFA in acetonitrile – water (1:99, v/v)
 B) 0.1 % TFA in acetonitrile – water (99:1, v/v)
 10–60 % B in 20 min
 Flow rate: 1 mL/min
 Detection: UV, 220 nm

- Peaks:
1. ACP(66-74)(H-Gln)
 2. ACP(65-74)
 3. ACP(66-74)(Glp)
 4. Thioanisole

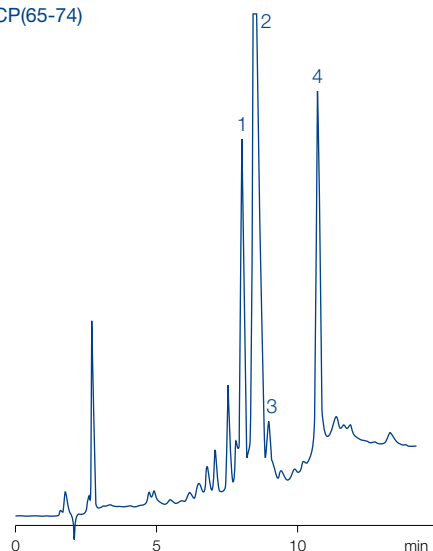

Ordering information

Eluent in column acetonitrile – water

ID	Length →			Guard columns*
	50 mm	150 mm	250 mm	
NUCLEOGEL® RP 100-5 particle size 5 µm, pore size 100 Å				
Analytical Valco type columns				
4.6 mm		719454	719455	719542
NUCLEOGEL® RP 100-8 particle size 8 µm, pore size 100 Å				
Analytical Valco type columns				
4.6 mm		719456	719520	719542
NUCLEOGEL® RP 300-5 particle size 5 µm, pore size 300 Å				
Analytical Valco type columns				
4.6 mm	719459			719542
NUCLEOGEL® RP 300-8 particle size 8 µm, pore size 300 Å				
Analytical Valco type columns				
4.6 mm	719460			719542

* Valco type guard columns measure 5 x 3 mm and require Guard column holder B, REF 719539, see page 250.

Columns in packs of 1, guard columns in packs of 2.



HPLC columns for sugar analyses



NUCLEOSIL® Carbohydrate separation of mono- and disaccharides · USP L8

Technical data

• Matrix: NUCLEOSIL® silica with amino modification, particle size 10 µm

Recommended application

• RP separation of mono- and disaccharides

Separation of sugars

MN Appl. No. 102480

Column: 250 x 4 mm NUCLEOSIL® Carbohydrate
Eluent: acetonitrile – water (79:21, v/v)
Flow rate: 2 mL/min
Temperature: 25 °C
Detection: RI
Injection: 10 µL

Peaks:

1. Fructose
2. Glucose
3. Saccharose
4. Maltose
5. Lactose

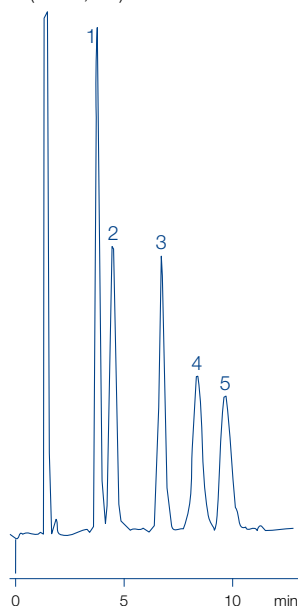

Ordering information

Eluent in column acetonitrile – water (79:21, v/v)

ID	Length → 250 mm	EC guard columns*
----	--------------------	-------------------

NUCLEOSIL® Carbohydrate

Analytical EC columns

 4 mm	720905.40	721170.30
--	-----------	-----------

* EC 4/3 guard columns for EC columns with 4 mm ID require the Column Protection System guard column holder (REF 718966, see page 251). Columns and guard columns in packs of 1.



NUCLEOGEL® SUGAR 810 separation of sugars · USP L17 (H-Form) · USP L19 (Ca form)

Technical data

- Sulfonated polystyrene - divinylbenzene resins in different ionic forms; due to a different selectivity pattern compared to NUCLEOGEL® SUGAR columns, the range of application is considerably enlarged
- Separation mechanism: ion exclusion, ion exchange, size exclusion, ligand exchange, NP and RP chromatography

Recommended application

- H⁺ form: Separation of sugars, sugar alcohols and organic acids; eluent in column 5 mmol/L H₂SO₄
- Ca²⁺ form: Separation of mono-, di- and oligosaccharides; eluent in column water

Organic acids and alcohols

MN Appl. No. 113870

Column: 300 x 7.8 mm NUCLEOGEL® SUGAR 810 H
 Eluent: 5 mmol/L H₂SO₄
 Flow rate: 0.6 mL/min
 Temperature: 35 °C
 Detection: RI
 Injection: 5 µL

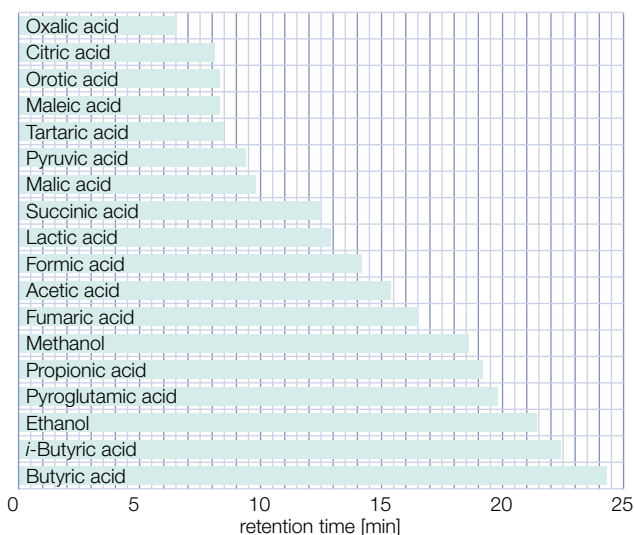

Sugars and sugar alcohols

MN Appl. No. 114160

Column: 300 x 7.8 mm NUCLEOGEL® SUGAR 810 Ca
 Eluent: water
 Flow rate: 0.6 mL/min
 Temperature: 85 °C
 Detection: RI

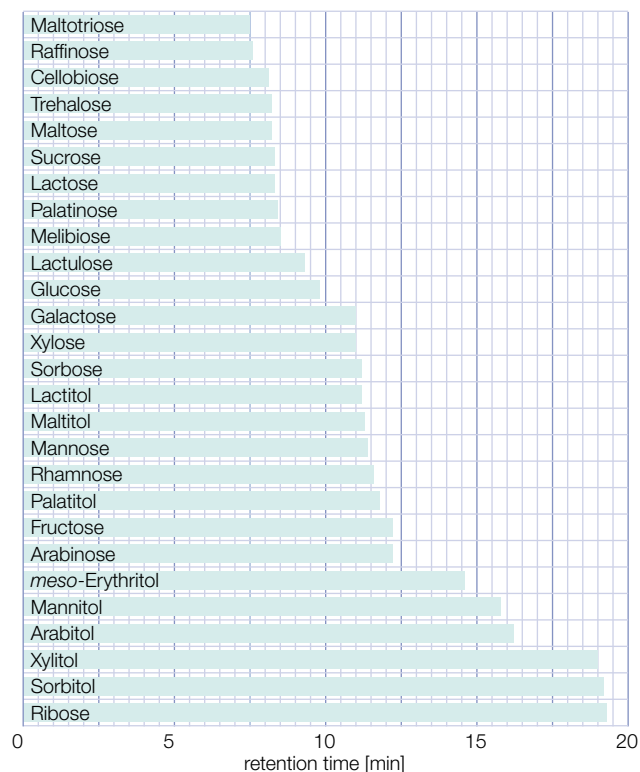

Ordering information

ID	Length → 300 mm	Guard columns*
NUCLEOGEL® SUGAR 810 H eluent in column 5 mmol/L H ₂ SO ₄		
Analytical Valco type columns		
7.8 mm	719574	719575
NUCLEOGEL® SUGAR 810 Ca eluent in column water		
Analytical Valco type columns		
7.8 mm	719570	719571

* NUCLEOGEL® SUGAR 810 guard columns measure 30 x 4 mm and require the CC column holder 30 mm (REF 721823)
 Columns in packs of 1, guard columns in packs of 2.



HPLC columns for sugar analyses



NUCLEOGEL® ION 300 OA / SUGAR

separation of sugars · USP L17 (H form) · USP L19 (Ca form) · USP L34 (Pb form) · USP L58 (Na form)

Technical data

- Sulfonated spherical PS/DVB resins in different ionic forms; mean particle size 10 µm, pore size 100 Å
- Separation mechanism includes steric exclusion, ligand exchange and partition effects, ligand exchange being the predominant force, since the hydrated metal ions form strong interactions with the hydroxyl groups of the sample molecules. The intensity of these interactions decreases in the sequence Pb > Ca > Na
- Recommended operating temperatures: 60–95 °C; maximum pressure 70 bar

Recommended application

- NUCLEOGEL® ION 300 OA:
H⁺ form for separation of sugars, alcohols and organic acids
- NUCLEOGEL® SUGAR:
Ca²⁺ form: separation of mono- and oligosaccharides, sugar alcohols
- Pb²⁺ form: separation of mono- and disaccharides from food and biological samples
- Na⁺ form: separation of oligosaccharides from starch hydrolysates and food

Separation of carbohydrates

MN Appl. No. 102430

Column: 300 x 7.8 mm NUCLEOGEL® SUGAR Pb
 Eluent: deionized water
 Flow rate: 0.4 mL/min
 Temperature: 80 °C
 Detection: RI

Peaks:

1. Sucrose
2. Maltose
3. Glucose
4. Xylose
5. Galactose
6. Arabinose
7. Mannose

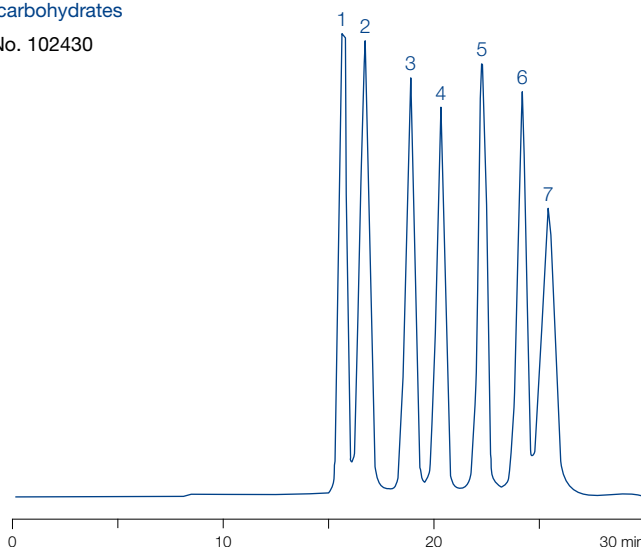

Ordering information

ID	Length → 300 mm	Guard columns*
NUCLEOGEL® ION 300 OA eluent in column 5 mmol/L H ₂ SO ₄ 5 mmol/L H ₂ SO ₄		
Analytical Valco type columns 7.8 mm	719501	719537
NUCLEOGEL® SUGAR Ca eluent in column water + 0.02 % azide		
Analytical Valco type columns 6.5 mm	719531	719535
NUCLEOGEL® SUGAR Pb eluent in column water + 0.02 % azide		
Analytical Valco type columns 7.8 mm	719530	719534
NUCLEOGEL® SUGAR Na eluent in column water + 0.02 % azide		
Analytical Valco type columns 7.8 mm	719532	719536

* Valco Type guard columns measure 21 x 4 mm and require the guard column holder C, REF 719538, see page 250.
 Columns in packs of 1, guard columns in packs of 2.



NUCLEOGEL® GPC for GPC of water-insoluble substances

Technical data

- Highly crosslinked macroporous, spherical polystyrene – divinylbenzene polymer matrix with good mechanical stability

Chromatogram of styrene oligomers

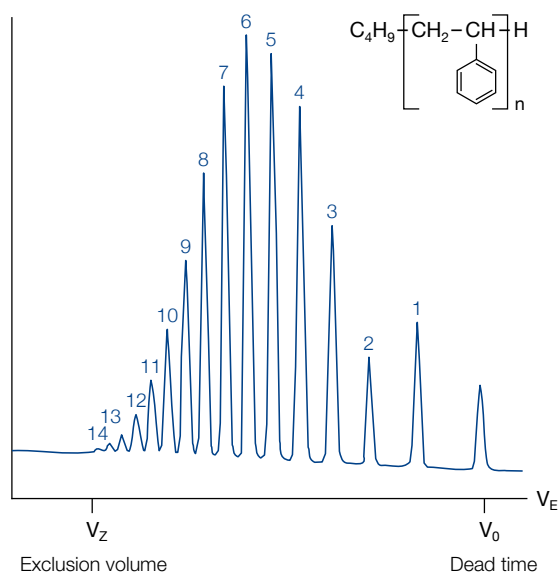

Working ranges for polystyrene

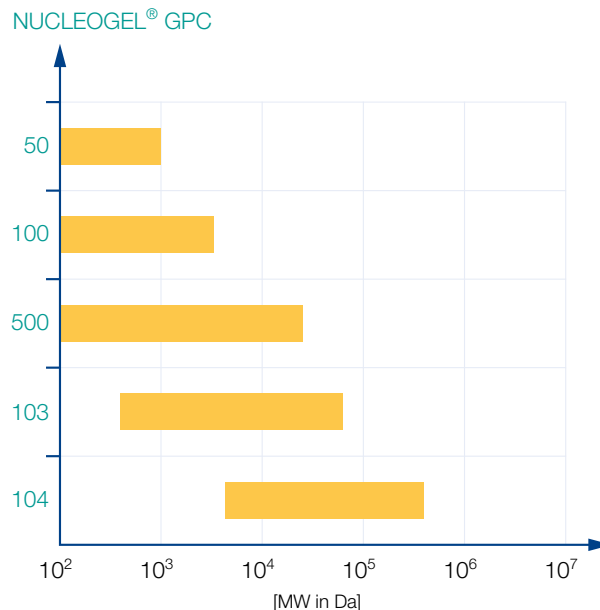

Ordering information

Eluent in column toluene

Phase	Exclusion limit [kDalton]	Application	Column 300 x 7.7 mm	
5 µm particle size				
Analytical Valco type columns				
	NUCLEOGEL GPC 50	2	low molecular weight organics	719402
	NUCLEOGEL GPC 100	4	oligomers, oils	719403
	NUCLEOGEL GPC 500	25	low molecular weight polymers	719404
	NUCLEOGEL GPC 103	60	low molecular weight polymers	719405
	NUCLEOGEL GPC 104	500	polymers up to 500 kDa	719406
		guard columns 50 x 7.7 mm	719409	
10 µm particle size				
Analytical Valco type columns				
	NUCLEOGEL GPC 50	2	low molecular weight organics	719410
	NUCLEOGEL GPC 100	4	oligomers, oils	719411
	NUCLEOGEL GPC 500	25	low molecular weight polymers	719412
	NUCLEOGEL GPC 103	60	low molecular weight polymers	719413
	NUCLEOGEL GPC 104	500	polymers up to 500 kDa	719414
		guard columns 50 x 7.7 mm	719418	

Columns and guard columns in packs of 1.

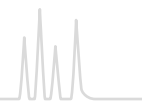

EC standard columns for analytical HPLC / UHPLC



- Analytical column system manufactured from stainless steel M8 outer threads on both ends combination of sealing element and very fine-meshed stainless steel screen, PTFE ring and fitting adaptor column heads SW 12, with inner threads M8 x 0.75 and UNF 10-32 (= 1/16" connection)
- EC column hardware guarantees pressure stability of 1200 bar - hereby EC columns are suitable for UHPLC applications (ultra fast HPLC) and all modern HPLC systems.
- As screw-on guard column system we recommend the Column Protection System used with EC guard column cartridges with 4 mm length.
- EC guard columns supplied with NUCLEODUR[®], NUCLEOSIL[®] spherical silicas and NUCLEOSHELL[®] spherical core shell silica particles

Available standard dimensions of EC columns

ID	Length →									
	20 mm	30 mm	50 mm	75 mm	100 mm	125 mm	150 mm	200 mm	250 mm	300 mm
2 mm	+	+	+	+	+	+	+	+	+	+
3 mm	+	+	+	+	+	+	+	+	+	+
4 mm	+	+	+	+	+	+	+	+	+	+
4.6 mm	+	+	+	+	+	+	+	+	+	+

Please ask for availability of certain phases.

Note: NUCLEODUR[®] and NUCLEOSHELL[®] column head must not be removed!

Guard columns for EC columns

EC column with ID	EC guard column*
2 mm	4/2
3 mm	4/3
3 mm	4/3
3 mm	4/3

Packs of 3 cartridges

* Information about the Column Protection System on page 251.

For preparative applications MN offers the so-called VarioPrep[®] hardware system, which is described from page 252 on.

Valco type columns



- Analytical column system manufactured from stainless steel
- Available inner diameters: 4.6 mm ID (1/4" OD) and 7.7 mm (3/8" OD)
- Mainly used for NUCLEOGEN[®] and NUCLEOGEL[®] (see page 226)

Ordering information

Description	Pack of	REF
Accessories for Valco type columns		
Guard column holder B for VA columns 5 x 3 mm	1	719539
Guard column holder C for VA guard columns 21 x 4 mm	1	719538



Column Protection System

Innovative and universal guard column holder system

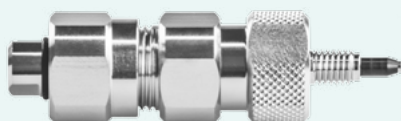

- Suitable for all analytical HPLC columns with 1/16" fittings
- Cartridges filled with special NUCLEODUR®, NUCLEOSIL® and NUCLEOSHELL® HPLC adsorbents
- Ideal protection for your analytical main column → significant increase in column lifetime
- Minimized dead volume → suitable also for ultra-fast HPLC
- Special ferrules → pressure stability up to 1300 bar (18 850 psi)
- Visual contamination check → in-time changing of the guard column
- Suitable guard columns with 4 mm length, 2 mm ID (for main columns with 2 mm ID); 3 mm ID (for main columns with 3, 4 and 4.6 mm), respectively
- UNIVERSAL RP guard columns suitable for all HPLC columns under RP conditions

Content of the Column Protection System



Description	Pack of	REF
Guard column holder	1	718966
Capillaries (0.12 mm ID)	2	
Ferrules	3	
Wrenches	2	
Manual	1	

Ordering information

Description	Pack of	REF
Replacement parts for the Column Protection System		
Special ferrules made of PEEK	5	718967
Replacement connector including O-ring	1	718968
Stainless steel capillaries 0.12 mm ID, nuts and metal ferrules	3	718969
Stainless steel capillaries 0.18 mm ID (for higher flow rates), nuts and metal ferrules	3	718971
Wrench (size 12 and 14 mm)	1	718970
EC 4/2 UNIVERSAL RP guard column (for main columns with 2 mm ID)	3	728777.20
EC 4/2 UNIVERSAL RP guard column (for main columns with 2 mm ID), value pack	9	728778.20
EC 4/3 UNIVERSAL RP guard column (for main columns with 3, 4 and 4.6 mm ID)	3	728777.30
EC 4/3 UNIVERSAL RP guard column (for main columns with 3, 4 and 4.6 mm ID), value pack	9	728778.30

Visual contamination check

The cartridge is fitted with a special filter membrane:

- If this silver membrane is contaminated (bright or dark discoloration), it is advisable to replace the cartridge.
- If the contaminants are colorless, replace the cartridge if the pressure rises or the chromatographic performance decreases.

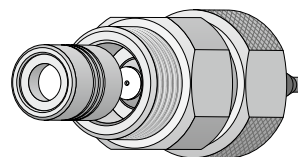

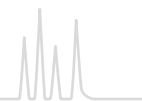

VarioPrep (VP) columns for preparative HPLC



- Column system for preparative HPLC, manufactured from stainless steel with two adjustable end fittings, suitable for frequent use of back-flushing techniques
- Allows compensation of a dead volume, which could occur at the column inlet after some time of operation, without need for opening the column
- Can be packed with all NUCLEODUR® and NUCLEOSIL® spherical silicas

Available standard dimensions of VarioPrep columns with axially adjustable end fittings

End fitting design	ID	Length →		Length →						
		10* mm	15* mm	50 mm	75 mm	100 mm	125 mm	150 mm	250 mm	500 mm
	8	+		+		+	+	+	+	
	10			+		+	+	+	+	
	16	+		+		+	+	+	+	
	21			+	+	+	+	+	+	
	32		+			+		+	+	
	40			+		+	+	+	+	+
	50		+			+		+	+	
	80								+	+

* 10 x 8, 10 x 16, 15 x 32 and 15 x 50 mm ID columns are used as guard columns and require the respective holders, see page 253.

The VarioPrep principle

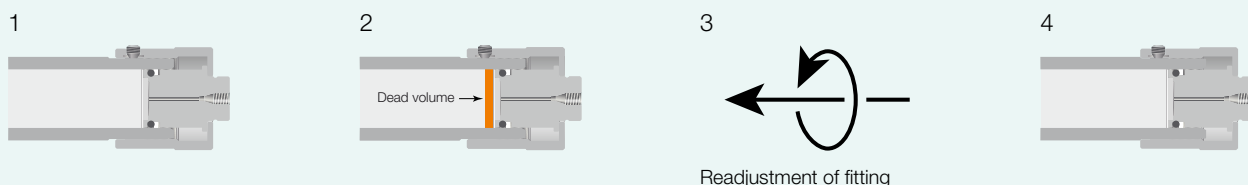

VarioPrep columns are produced with highest packing quality and bed density (1). Due to intensive chemical and/or mechanical exposure of the column adsorbent, shrinking of the column bed can occur (2; orange gap). In this even unlikely case readjustment of the VarioPrep

column fitting (3; turning the nut at the column inlet clockwise) will eliminate the emerged dead volume (4). The performance of the VarioPrep column is completely reconstituted and column lifetime is significantly extended.

Column reconstitution

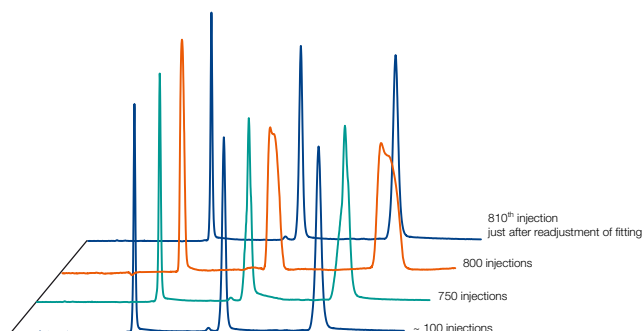

Reconstitution of VarioPrep column performance

- Slight peak broadening and deformation after 800 injections under strongly demanding conditions (pH 11; 50 °C; sample in DMSO)
- Readjustment of the column fitting restores column performance and prolongs column lifetime noticeably.



The improved guard column system for (semi-) preparative HPLC



- ① VP 15/32 for 32 and 40 mm ID columns
- ② VP 10/16 for 16 and 21 mm ID columns
- ③ VP 10/8 for 8 and 10 mm ID columns
- ④ VP 15/50 for ≥ 50 mm ID columns

- Easy handling and cartridge exchange
- Robust hardware
- Free rotary plunger fittings – low O-ring abrasion
- Cost-efficient cartridges
- Minimally invasive / no disturbance of the separation efficiency of main column
- Low back pressure
- Designed for pressures up to 400 bar

Column performance without and with guard column

Columns: 125 x 16 mm NUCLEODUR® C₁₈ HTec, 5 μ m
 125 x 16 mm NUCLEODUR® C₁₈ HTec, 5 μ m + 10 x 16 mm NUCLEODUR® C₁₈ HTec guard column
 Eluent: acetonitrile – water (80:20, v/v)
 Flow rate: 16 mL/min
 Temperature: 22 °C

- Peaks:
 1. Phenol
 2. Naphthalene
 3. Anthracene

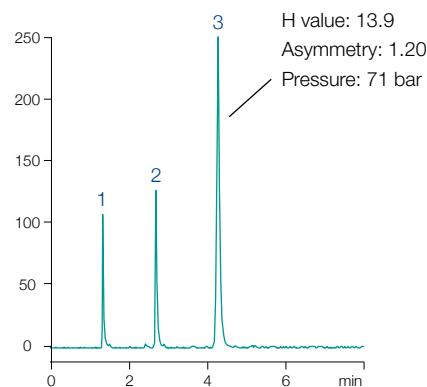
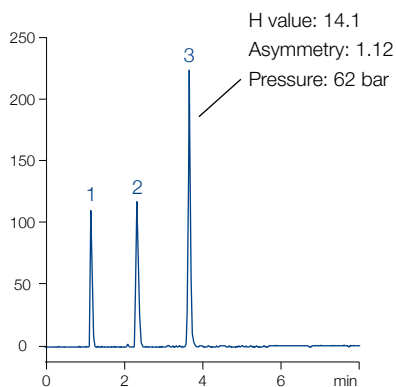

Using VarioPrep guard columns provides ideal protection of your main column – symmetry, pressure and retention stay almost constant.

Technical data

• 1/16" thread • free rotary plunger fittings – low O-ring abrasion • stainless steel

Guard cartridge	Holder REF	Holder ID	Recommended for column ID	Preferred capillary ID	Typical flow rate
VP 10/8	718251	8 mm	8 and 10 mm ID	0.17 and 0.25 mm	1–12 mL/min
VP 10/16	718256	16 mm	16 and 21 mm ID	0.17, 0.25 and 0.5 mm	2–32 mL/min
VP 15/32	718253	32 mm	32 and 40 mm ID	0.25, 0.5 and 1.0 mm	5–150 mL/min
VP 15/50	718255	50 mm	≥ 50 mm ID	0.5 and 1.0 mm	20–250 mL/min

Ordering information

Guard column holders for VarioPrep columns

VP Guard columns for VarioPrep columns with ID →				Pack of guard columns	Replacement O-ring (pack of 2)	Holder ID	REF
8, 10 mm	16, 21 mm	32, 40 mm	≥ 50 mm				
VP 10/8				2	718975	8 mm	718251
VP	10/16			2	718976	16 mm	718256
VP		15/32		1	718977	32 mm	718253
VP			15/50	1	718978	50 mm	718255

For REF numbers of individual VP guard column cartridges see respective NUCLEODUR® and NUCLEOSIL® phases.



Accessories for stainless steel HPLC columns

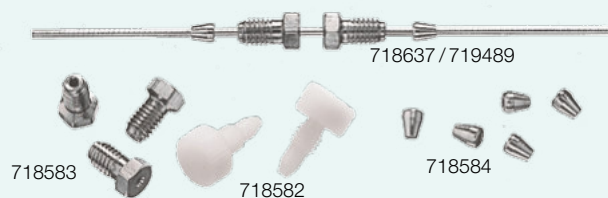

- Stainless steel columns are most frequently used in HPLC.
- The material is corrosion resistant, pressure stable and easy to work mechanically.

Ordering information

Description	Pack of	REF
Capillary accessories		
1/16" column end caps (plastic)	4	718582
1/16" nut for connecting 1/16" capillaries	5	718583
1/16" ferrule	5	718584
Capillary unions		
Typ 1: 100 mm x 1/16" x 0.25 mm	1	718637
Typ 2: 100 mm x 1/16" x 0.12 mm	1	719489
Cutter for 1/16" capillary tubing	1	706290

For accessories and replacement parts for EC columns see page 251, for accessories and replacement parts for VarioPrep columns see page 253.



SPE accessories for sample preparation, like e.g., CHROMABOND® vacuum manifolds can be found on page 65.



PEEK accessories

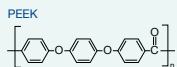

• PEEK (= polyether ether ketone) is a high performance polymer belonging to the group of polyarylether ketones (PAEK), which meets all requirements of HPLC columns with respect to chemical resistance and mechanical stability. In some fields of application in HPLC like, e.g., in ion chromatography and chromatography of biopolymers, PEEK fulfils the requirements for a nonmetallic material.

• All fittings can be tightened by hand.

Ordering information

Description	Pack of	REF
PEEK fittings		
1/16" PEEK fingertight fitting, 1-part combination nut + ferrule	1	718770
1/16" PEEK fingertight Nut	1	718771
1/16" PEEK ferrule for REF 718771	1	718772
1/16" PEEK double ferrule	1	718775



1/16" PEEK union, both sides inner threads, equipped with 2 fingertight nuts and double ferrules	1	718766	
1/16" PEEK union, both sides inner threads, however without nuts and without ferrules	1	718767	
1/16" PEEK union, both sides outer threads	1	718768	

AD	ID [mm]	Length	Pack of	REF
PEEK standard capillaries				
1/16"	0.13	1 m	1	718765
1/16"	0.17	1 m	1	718760
1/16"	0.25	1 m	1	718761
1/16"	0.5	1 m	1	718762
1/16"	0.75	1 m	1	718763

Description	Pack of	REF
-------------	---------	-----

Tools for PEEK capillaries

Guillotine cutter for PEEK and PTFE capillaries	1	718769	
Clean-Cut cutter for different capillary outer diameters	1	718755	



Basics of preparative HPLC

In principal for preparative HPLC the same rules apply than for analytic HPLC. However both differ significantly in their aim. The aim of analytic HPLC is a preferably complete separation of the single components of a mixture with subsequent peak identification. In contrast the goal of preparative HPLC is isolation of the desired product in defined purity, maximum amount while having a cost effective method of operating.

Demand of a preparative separation

- Throughput
- Purity
- Yield

Upscaling table for current MN column dimensions

	•	•	•	•	•	•	•	•	•
ID x Length [mm]	4 x 250	8 x 250	10 x 250	16 x 250	21 x 250	32 x 250	40 x 250	50 x 250	80 x 250
Linear scale-up factor	1	4	6.25	16	27.6	64	100	156.3	400
Typical amount of sample* [mg]	0.02–2	0.08–8	0.13–13	0.3–35	0.6–60	1.3–130	2–210	3–350	10–850
Typical flow rate [mL/min]	0.5–1.5	2–6	3–9	8–24	14–40	32–96	50–150	80–250	200–600

* based on RP material; the herein stated maximum amounts of sample are dependent on the separation problem and the sample. In some cases half the maximum amount of sample can already lead to a drastic overload of the column, in other cases the maximum amount of sample still leads to an acceptable separation.

NUCLEODUR[®] bulk packings

- Fully spherical high purity silica
- Pore size 110 Å; pore volume 0.9 mL/g; surface (BET) 340 m²/g; density 0.47 g/mL; pressure stable up to 600 bar
- Bigger particles for preparative application

Ordering information

Phase	Endcapped	Carbon content	Particle size	Pack of 100 g	Pack of 1000 g
NUCLEODUR[®] C₁₈ HTec premium octadecyl phase (see page 178)					
NUCLEODUR [®] C ₁₈ HTec, 7 µm	yes	18 % C	7 µm	713831.0100	713831.1
NUCLEODUR [®] C ₁₈ HTec, 10 µm	yes	18 % C	10 µm	713832.0100	713832.1
NUCLEODUR[®] C₁₈ ec standard octadecyl phase (see page 181)					
NUCLEODUR [®] 100-10 C ₁₈ ec	yes	17.5 % C	10 µm	713611.0100	713611.1
NUCLEODUR [®] 100-12 C ₁₈ ec	yes	17.5 % C	12 µm	713618.0100	713618.1
NUCLEODUR [®] 100-16 C ₁₈ ec	yes	17.5 % C	16 µm	713621.0100	713621.1
NUCLEODUR [®] 100-20 C ₁₈ ec	yes	17.5 % C	20 µm	713601.0100	713601.1
NUCLEODUR [®] 100-30 C ₁₈ ec	yes	17.5 % C	30 µm	713631.0100	713631.1
NUCLEODUR [®] 100-50 C ₁₈ ec	yes	17.5 % C	50 µm	713550.0100	713550.1
Unmodifiziertes NUCLEODUR[®] SiOH silica (see page 190)					
NUCLEODUR [®] 100-10			10 µm	713610.0100	713610.1
NUCLEODUR [®] 100-12			12 µm	713615.0100	713615.1
NUCLEODUR [®] 100-16			16 µm	713620.0100	713620.1
NUCLEODUR [®] 100-20			20 µm	713600.0100	713600.1
NUCLEODUR [®] 100-30			30 µm	713630.0100	713630.1
NUCLEODUR [®] 100-50			50 µm	713551.0100	713551.1



POLYGOSIL[®] bulk packings

- Irregular silica for analytical applications
- pH stability 2–8

Physical properties of unmodified POLYGOSIL[®] materials

Phase	Pore size	Pore volume	Surface (BET)	Density	Pressure stability
POLYGOSIL [®] 60	60 Å	0.75 mL/g	350 m ² /g	0.45 g/mL	600 bar
POLYGOSIL [®] 100	100 Å	1 mL/g	280 m ² /g	0.35 g/mL	400 bar
POLYGOSIL [®] 300	300 Å	0.8 mL/g	100 m ² /g	0.45 g/mL	400 bar
POLYGOSIL [®] 1000	1000 Å	0.8 mL/g	25 m ² /g	0.45 g/mL	300 bar

Modification of POLYGOSIL[®] follows the same processes as for NUCLEOSIL[®] silica.

Ordering information

Phase	Endcapped	Carbon content	Pore size	Particle size	Pack of 10 g	Pack of 100 g
Octadecyl phases –(CH₂)₁₇–CH₃						
POLYGOSIL [®] 60-5 C ₁₈	yes	12 % C	60 Å	5 µm	711330.10	711330.100
POLYGOSIL [®] 60-7 C ₁₈	yes	12 % C	60 Å	7 µm	711340.10	711340.100
POLYGOSIL [®] 60-10 C ₁₈	yes	12 % C	60 Å	10 µm	711350.10	711350.100
POLYGOSIL [®] 100-5 C ₁₈	yes	14 % C	100 Å	5 µm	711560.10	711560.100
POLYGOSIL [®] 100-7 C ₁₈	yes	14 % C	100 Å	7 µm	711570.10	711570.100
POLYGOSIL [®] 100-10 C ₁₈	yes	14 % C	100 Å	10 µm	711580.10	711580.100
POLYGOSIL [®] 300-7 C ₁₈	yes	4 % C	300 Å	7 µm	711710.10	711710.100
POLYGOSIL [®] 1000-7 C ₁₈	yes	~ 1 % C	1000 Å	7 µm	711992.10	711992.100
Octyl phases –(CH₂)₇–CH₃						
POLYGOSIL [®] 60-5 C ₈	no	7 % C	60 Å	5 µm	711300.10	711300.100
POLYGOSIL [®] 60-7 C ₈	no	7 % C	60 Å	7 µm	711310.10	711310.100
POLYGOSIL [®] 60-10 C ₈	no	7 % C	60 Å	10 µm	711320.10	711320.100
Butyl phases –(CH₂)₃–CH₃						
POLYGOSIL [®] 300-7 C ₄	yes	~ 1 % C	300 Å	7 µm	711680.10	711680.100
POLYGOSIL [®] 1000-7 C ₄	yes	< 1 % C	1000 Å	7 µm	711991.10	711991.100
Cyano phases (nitrile) –(CH₂)₃–CN						
POLYGOSIL [®] 60-5 CN		~ 5 % C	60 Å	5 µm	711380.10	711380.100
POLYGOSIL [®] 60-10 CN		~ 5 % C	60 Å	10 µm	711390.10	711390.100
Amino phases –(CH₂)₃–NH₂						
POLYGOSIL [®] 60-5 NH ₂		~ 3 % C	60 Å	5 µm	711360.10	711360.100
POLYGOSIL [®] 60-10 NH ₂		~ 3 % C	60 Å	10 µm	711370.10	711370.100
Dimethylamino phases –(CH₂)₃–N(CH₃)₂						
POLYGOSIL [®] 60-5 N(CH ₃) ₂		~ 3.5 % C	60 Å	5 µm	711420.10	711420.100
POLYGOSIL [®] 60-10 N(CH ₃) ₂		~ 3.5 % C	60 Å	10 µm	711430.10	711430.100
Unmodified silica SiOH						
POLYGOSIL [®] 60-5			60 Å	5 µm	711010.10	711010.100
POLYGOSIL [®] 60-7			60 Å	7 µm	711280.10	711280.100
POLYGOSIL [®] 60-10			60 Å	10 µm	711020.10	711020.100
POLYGOSIL [®] 100-5			100 Å	5 µm	711510.10	711510.100
POLYGOSIL [®] 100-7			100 Å	7 µm	711520.10	711520.100
POLYGOSIL [®] 100-10			100 Å	10 µm	711530.10	711530.100
POLYGOSIL [®] 300-7			300 Å	7 µm	711600.10	711600.100
POLYGOSIL [®] 1000-7			1000 Å	7 µm	711890.10	711890.100

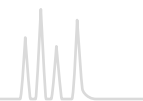

POLYGOPREP bulk packings

- Irregular silica for preparative applications
- pH stability 2–8

Physical properties of unmodified POLYGOPREP materials

Phase	Pore size	Pore volume	Surface (BET)	Density	Pressure stability
POLYGOPREP 60	60 Å	0.75 mL/g	350 m ² /g	0.45 g/mL	600 bar
POLYGOPREP 100	100 Å	1 mL/g	280 m ² /g	0.35 g/mL	400 bar
POLYGOPREP 300	300 Å	0.8 mL/g	100 m ² /g	0.45 g/mL	400 bar
POLYGOPREP 1000	1000 Å	0.8 mL/g	35 m ² /g	0.45 g/mL	300 bar

Modification of POLYGOPREP follows the same processes as for NUCLEOSIL® silica.

Ordering information

Phase	Endcapped	Carbon content	Pore size	Particle size	Pack of 100 g	Pack of 1 kg
Octadecyl phases –(CH₂)₁₇–CH₃						
POLYGOPREP 60-12 C ₁₈	no*	12% C	60 Å	10–15 µm	711009.100	711009.1000
POLYGOPREP 60-20 C ₁₈	no*	12% C	60 Å	15–25 µm	711031.100	711031.1000
POLYGOPREP 60-30 C ₁₈	no*	12% C	60 Å	25–40 µm	711480.100	711480.1000
POLYGOPREP 60-50 C ₁₈	no*	12% C	60 Å	40–63 µm	711500.100	711500.1000
POLYGOPREP 60-80 C ₁₈	no*	12% C	60 Å	63–100 µm	711011.100	711011.1000
POLYGOPREP 60-130 C ₁₈	no*	12% C	60 Å	63–200 µm	711590.100	711590.1000
POLYGOPREP 100-12 C ₁₈	no*	14% C	100 Å	10–15 µm	711018.100	711018.1000
POLYGOPREP 100-20 C ₁₈	no*	14% C	100 Å	15–25 µm	711019.100	711019.1000
POLYGOPREP 100-30 C ₁₈	no*	14% C	100 Å	25–40 µm	711032.100	711032.1000
POLYGOPREP 100-50 C ₁₈	no*	14% C	100 Å	40–63 µm	711021.100	711021.1000
POLYGOPREP 300-12 C ₁₈	yes	4% C	300 Å	10–15 µm	711024.100	711024.1000
POLYGOPREP 300-20 C ₁₈	yes	4% C	300 Å	15–25 µm	711025.100	711025.1000
POLYGOPREP 300-30 C ₁₈	yes	4% C	300 Å	25–40 µm	711720.100	711720.1000
POLYGOPREP 300-50 C ₁₈	yes	4% C	300 Å	40–63 µm	711730.100	711730.1000
POLYGOPREP 1000-30 C ₁₈	yes	~ 1% C	1000 Å	25–40 µm	711028.100	711028.1000
POLYGOPREP 1000-50 C ₁₈	yes	~ 1% C	1000 Å	40–63 µm	711029.100	711029.1000
Octyl phases –(CH₂)₇–CH₃						
POLYGOPREP 60-12 C ₈	no*	7% C	60 Å	10–15 µm	711007.100	711007.1000
POLYGOPREP 60-20 C ₈	no*	7% C	60 Å	15–25 µm	711008.100	711008.1000
POLYGOPREP 60-30 C ₈	no*	7% C	60 Å	25–40 µm	711470.100	711470.1000
POLYGOPREP 60-50 C ₈	no*	7% C	60 Å	40–63 µm	711490.100	711490.1000
* On request, these POLYGOPREP RP phases can be endcapped at surcharge.						
Butyl phases –(CH₂)₃–CH₃						
POLYGOPREP 300-12 C ₄	yes	~ 1% C	300 Å	10–15 µm	711022.100	711022.1000
POLYGOPREP 300-20 C ₄	yes	~ 1% C	300 Å	15–25 µm	711023.100	711023.1000
POLYGOPREP 300-30 C ₄	yes	~ 1% C	300 Å	25–40 µm	711690.100	711690.1000
POLYGOPREP 300-50 C ₄	yes	~ 1% C	300 Å	40–63 µm	711700.100	711700.1000
POLYGOPREP 1000-30 C ₄	yes	< 1% C	1000 Å	25–40 µm	711026.100	711026.1000
POLYGOPREP 1000-50 C ₄	yes	< 1% C	1000 Å	40–63 µm	711027.100	711027.1000
Cyano phases (nitrile) –(CH₂)₃–CN						
POLYGOPREP 60-12 CN		~ 4.5% C	60 Å	10–15 µm	711015.100	711015.1000
POLYGOPREP 60-20 CN		~ 4.5% C	60 Å	15–25 µm	711016.100	711016.1000
POLYGOPREP 60-30 CN		~ 4.5% C	60 Å	25–40 µm	711017.100	711017.1000
Amino phases –(CH₂)₃–NH₂						
POLYGOPREP 60-12 NH ₂		~ 3% C	60 Å	10–15 µm	711012.100	711012.1000
POLYGOPREP 60-20 NH ₂		~ 3% C	60 Å	15–25 µm	711013.100	711013.1000
POLYGOPREP 60-30 NH ₂		~ 3% C	60 Å	25–40 µm	711014.100	711014.1000

POLYGOPREP irregular silica for HPLC



Ordering information

Phase	Pore size	Particle size	Pack of 100 g	Pack of 1 kg	Pack of 5 kg
Unmodified POLYGOPREP silica SiOH					
POLYGOPREP 60-12	60 Å	10–15 µm		711001.1000	711001.5000
POLYGOPREP 60-20	60 Å	15–25 µm		711240.1000	711240.5000
POLYGOPREP 60-30	60 Å	25–40 µm		711250.1000	711250.5000
POLYGOPREP 60-50	60 Å	40–63 µm		711260.1000	711260.5000
POLYGOPREP 60-80	60 Å	63–100 µm		711270.1000	711270.5000
POLYGOPREP 60-130	60 Å	63–200 µm		711037.1000	711037.5000
POLYGOPREP 100-12	100 Å	10–15 µm		711002.1000	711002.5000
POLYGOPREP 100-20	100 Å	15–25 µm		711003.1000	711003.5000
POLYGOPREP 100-30	100 Å	25–40 µm		711540.1000	711540.5000
POLYGOPREP 100-50	100 Å	40–63 µm		711550.1000	711550.5000
POLYGOPREP 100-80	100 Å	63–100 µm		711033.1000	711033.5000
POLYGOPREP 100-130	100 Å	63–200 µm		711034.1000	711034.5000
POLYGOPREP 300-12	300 Å	10–15 µm	711004.100	711004.1000	
POLYGOPREP 300-20	300 Å	15–25 µm	711610.100	711610.1000	
POLYGOPREP 300-30	300 Å	25–40 µm	711620.100	711620.1000	
POLYGOPREP 300-50	300 Å	40–63 µm	711630.100	711630.1000	
POLYGOPREP 1000-12	1000 Å	10–15 µm	711035.100	711035.1000	
POLYGOPREP 1000-20	1000 Å	15–25 µm	711036.100	711036.1000	
POLYGOPREP 1000-30	1000 Å	25–40 µm	711005.100	711005.1000	
POLYGOPREP 1000-50	1000 Å	40–63 µm	711006.100	711006.1000	



Silica adsorbents for low pressure column chromatography



- Silica 60; pore size ~ 60 Å; pore volume ~ 0.75 mL/g; spec. surface BET ~ 500 m²/g highly porous, amorphous silicic acid in the form of hard, opalescent particles, prepared by precipitation of water glass with sulfuric acid
- For higher demands on the performance of column packings we recommend our high-purity irregular POLYGOPREP silicas (see before).
- Silica FIA for the fluorescence indicator adsorption procedure for the determination of hydrocarbon groups in the testing of liquid fuels in accordance with DIN 51791 and ASTM D 1319-58T
- The FIA method determines saturated hydrocarbons, olefins and aromatic hydrocarbons of a sample chromatographically by adsorption and desorption in a column filled with FIA silica, in the presence of a fluorescent dye mixture.

Ordering information

Description	Particle size	1 kg	5 kg	25 kg
Silica 60, 0.015–0.04 mm	–	815650.1	815650.5	815650.25
Silica 60, 0.025–0.04 mm	–	815300.1	815300.5	815300.25
Silica 60, 0.04–0.063 mm	230–400 mesh	815380.1	815380.5	815380.25
Silica 60 M, 0.04–0.063 mm	230–400 mesh	815381.1	815381.5	815381.25
Silica 60, 0.05–0.1 mm	130–270 mesh	815390.1	815390.5	815390.25
Silica 60, 0.05–0.2 mm	70–270 mesh	815320.1	815320.5	815320.25
Silica 60, 0.063–0.2 mm	70–230 mesh	815330.1	815330.5	815330.25
Silica 60, < 0.063 mm	+230 mesh	815400.1	815400.5	815400.25
Silica 60, < 0.08 mm	+190 mesh	815310.1	815310.5	815310.25
Silica 60, 0.1–0.2 mm	70–130 mesh	815340.1	815340.5	815340.25
Silica 60, 0.2–0.5 mm	35–70 mesh	815350.1	815350.5	815350.25
Silica 60, 0.5–1.0 mm	18–35 mesh	815360.1	815360.5	815360.25
Silica FIA fine	0.071–0.16 mm	815410.1		
Silica FIA coarse	0.071–0.63 mm	815430.1		

Aluminum oxide

- Aluminum oxides produced by dehydration of different aluminum hydroxides, e.g., hydrargillite between 400 and 500 °C.
- Activity grade I, particle size 50–200 µm, specific surface (BET) ~ 130 m²/g

Ordering information

Description	pH	1 kg	5 kg	25 kg
Aluminum oxide 90 basic	pH 9.5 ± 0.3	815010.1	815010.5	815010.25
Aluminum oxide 90 neutral	pH 7 ± 0.5	815020.1	815020.5	815020.25
Aluminum oxide 90 acidic	pH 4 ± 0.3	815030.1	815030.5	815030.25



Kieselguhr

- Naturally occurring amorphous silicic acids of fossil origin, also known as diatomaceous earth or diatomite purified for chromatographic applications
- Compared to silica, kieselguhr has a small surface of low activity → application in partition chromatography; impregnated with various substances (paraffin, silicone oil, undecane) it can be used for reversed phase chromatography
- The following grades of kieselguhr are manufactured by Johns-Manville. They are narrowly classified with homogeneous particle size distributions and high purity.
- For columns packed with kieselguhr please see CHROMABOND® XTR for liquid-liquid extraction, page 63.

Ordering information

Description	Rel. purification factor	Rel. flow rate	1 kg	5 kg
Filter-Cel®	100	100	815510.1	815510.5
Hyflo® Super-Cel®	58	534	815530.1	815530.5
Celite® 503	42	910	815540.1	815540.5
Celite® 535	35	1269	815550.1	815550.5
Celite® 545	32	1830	815560.1	815560.5

Florisil®

- Hard granular magnesia silica gel:
MgO 15.5 ± 0.5 % · SiO₂ 84.0 ± 0.5 % · Na₂SO₄ ≤ 1.0 %;
60/100 mesh
- Recommended application
Sample preparation (see chapter “Solid phase extraction”, page 16)
- Clean-up of pesticide residues, separation of chlorinated pesticides, extraction of steroids, sex hormones, antibiotics, lipids etc.

Ordering information

Description	Particle size	1 kg	5 kg
Florisil standard 60/100 mesh	0.15/0.25 mm	815710.1	815710.5



Polyamide

- Polyamide 6 = ϵ -polycaprolactam
- The separation mechanism mainly based on hydrogen bonds
- Recommended application
Separation of phenolic compounds (e.g., isolation of natural products) carboxylic acids, aromatic nitro compounds
- For SPE columns packed with polyamide see CHROMABOND® PA page 44.

Ordering information

Description	Particle size	1 kg	5 kg
Polyamide SC 6, < 0.07 mm	< 0.07 mm	815610.1	815610.5
Polyamide SC 6, 0.05–0.16 mm	0.05–0.16 mm	815620.1	815620.5
Polyamide SC 6, 0.10–0.30 mm	0.10–0.30 mm	815600.1	815600.5

Unmodified cellulose

- Cellulose MN 100:
native fibrous cellulose, standard grade average degree of polymerization 620–680, fiber length (85 %) 20–100 μm , specific surface acc. to Blaine ~ 6500 cm^2/g ; residue on ignition at 850 °C < 10000 ppm, < 20 ppm Fe, < 5 ppm Cu, < 7 ppm P, CH_2Cl_2 extract < 0.20 %
- Cellulose MN 2100:
native fibrous cellulose, purified grade (washed with different eluents) average degree of polymerization 620–680, fiber length (85 %) 20–75 μm , specific surface acc. to Blaine ~ 5500 cm^2/g residue on ignition at 850 °C < 1000 ppm, < 2 ppm Fe, < 1 ppm Cu, < 2 ppm P, CH_2Cl_2 extract < 0.15 %
- Grade MN 2100ff is a defatted cellulose MN 2100 with a CH_2Cl_2 extract < 0.02 %

Ordering information

Description	1 kg	5 kg	25 kg
Cellulose MN 100	815050.1	815050.5	815050.25
Cellulose MN 2100	815060.1	815060.5	815060.25
Cellulose MN 2100ff (Cellulose MN 2100 defatted)	815070.1		



MACHEREY-NAGEL

optimal autosampler vials for your sample

Vials and closures

For reliable and reproducible analysis the correct storage of sample solutions is important. MACHEREY-NAGEL offers diverse vials and suitable closures.

Our product range includes

- Different vial types from N 8 to N 24
 - Crimp neck
 - Screw neck
 - Snap ring
- Clear glass, amber glass and polypropylene vials, with or without scale and label
- Diverse inserts for small sample volumes
- Variety of closures and septa of different material
- Suitable accessories like crimping tools and vial containers
- Compatibility with different autosamplers from page 136 onwards



Our broad range of vials and closures can be found from page 97 onwards.

Also use our VialFinder on www.mn-net.com/VialFinder



Thin layer chromatography

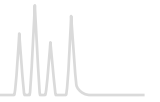

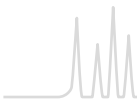

Contents

Basics.....	266
Introductory kits.....	269
Summary of MN ready-to-use layers.....	272
Unmodified TLC silica layers.....	274
Silica layers with concentrating zone.....	278
Unmodified HPTLC silica layers.....	280
Modified silica layers.....	283
Further layers.....	288
Layers for special TLC separations.....	291
Chromatography papers.....	294
Accessories.....	295
Reagents.....	296
Adsorbents.....	297

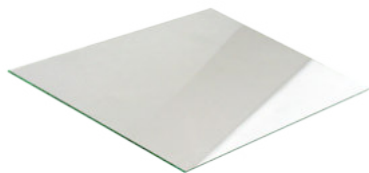

Glass plates

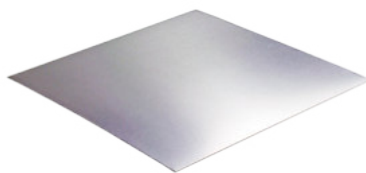

ALUGRAM® Xtra aluminum sheets
ALUGRAM® aluminum sheets



POLYGRAM® polyester sheets

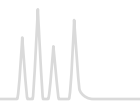

Thin layer chromatography (TLC) and high performance thin layer chromatography (HPTLC), also called planar chromatography, are, like all chromatographic techniques, based on a multi-stage distribution process involving

- Suitable adsorbents (the stationary phase) coated as a thin layer onto a suitable support (e.g., glass plate, polyester or aluminum sheet; also see page 272)
- Solvents or solvent mixtures (the mobile phase or eluent)
- Sample molecules

The principle of TLC is known for more than 100 years [11]. The real break-through as an analytical method, however, came about 50 years ago as a consequence of the pioneering work of Egon Stahl [12].

Today TLC has gained increasing importance as an analytical separation technique, which is probably due to effects of instrumentation and automation [13]. At the same time the applicability of thin layer chromatography was enhanced by development of new adsorbents and supports.

Today MACHEREY-NAGEL offers a versatile range of ready-to-use layers, which are the result of 50 years of continuous research and development.

Features of modern TLC / HPTLC

The success of thin layer chromatography as a highly efficient microanalytical separation method is based on a large number of advantageous properties:

- High sample throughput in a short time
- Suitable for screening tests
- Pilot procedure for HPLC and Flash chromatography
- After separation the analytical information can be stored for a longer period of time (the TLC ready-to-use layer acts as storage medium for data)
- Separated substances can be subjected to subsequent analytical procedures (e.g., IR, MS) at a later date
- Rapid and cost-efficient optimization of the separation due to easy change of mobile and stationary phase

Principle steps of a TLC separation

Sample preparation

For separation the sample must meet several requirements to obtain good results. Since the TLC plate is a disposable product, sample preparation in general is not as demanding as for other chromatographic methods. However, eventually several steps for sample pretreatment may be necessary. These include sampling, mechanical crushing, extraction steps, filtration and sometimes enrichment of interesting components or clean-up, i.e. removal of undesired impurities.

Our TLC micro-sets introduce some simple methods of sample pretreatment. The dyes or dye mixtures of the beginner's set do not require complicated procedures. The advanced sets require

the user to carry out some additional steps for preparing a sample, thus introducing the user to techniques often performed in industrial laboratories.

Thorough preparation of samples is an important prerequisite for the success of a TLC separation. For our range of products for more demanding sample pretreatment please see the chapter "SPE" from page 10.

Sample application

The most frequent technique is application with a glass capillary as spot or short streak.

Application as streak will yield better results especially for instrumental quantification. For both types of application some manual skill is required to obtain reproducible results. Substance zones which are too large from the beginning will cause poor separation since during chromatography they will become even larger and more diffuse.

A valuable aid for manual application especially of large volumes of very dilute samples is the concentrating zone (e.g., SILGUR-25 UV₂₅₄), which consists of a chromatographically inactive adsorbent (kieselguhr). The substances to be separated are concentrated to a small band in the concentrating zone and the separation starts at the beginning of the chromatographically active adsorbent silica.

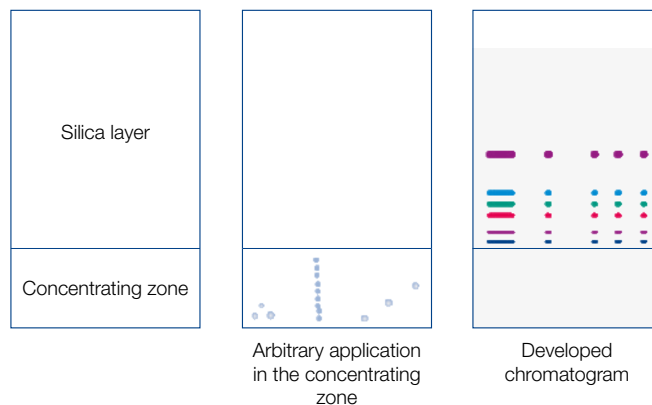

Another method for sample concentration is a short pre-elution (few mm) with a solvent, in which all substances have a high R_f value.

If a quantitative evaluation with a TLC scanner is to follow the separation we recommend to use commercially available sample applicators for spotting. These range from simple spotting guides via nanoapplicators to completely automated spotting devices. Application as streak can be performed automatically by spraying of the sample without touching the layer of the TLC plate. Application as band over the whole width of the TLC plate is especially important for preparative TLC. After application allow the solvent of the samples to evaporate completely (about 10 min) or blow with cold or hot air. Development of a chromatogram should never start before the solvent of the applied samples is evaporated completely.



Developing a chromatogram – separation techniques

The most frequently used separation technique is ascending TLC in a trough chamber (standard method, linear development). Usually it is applied as single development. However, multiple development, with or without change of eluent (step technique) can improve separation results. For 2-dimensional development only 1 spot of the sample is applied in one edge of a plate. After chromatography in the first direction the plate is dried, turned by 90° and developed in the 2nd dimension with another eluent. Thus complicated mixtures give 2-dimensional chromatograms taking advantage of the different separating properties of two eluents.

For selection and optimization of the eluent numerous publications are available. A generally applicable standardized optimization method is described by H. Keuker et al. [14].

It is important to pay attention to the atmosphere in the developing chamber. If reproducible migration distances are required, saturation of the chamber atmosphere with eluent vapor is necessary. For this purpose the developing chamber is lined with well absorbing chromatography paper (e.g., MN 260) and charged with a correspondingly larger volume of eluent.

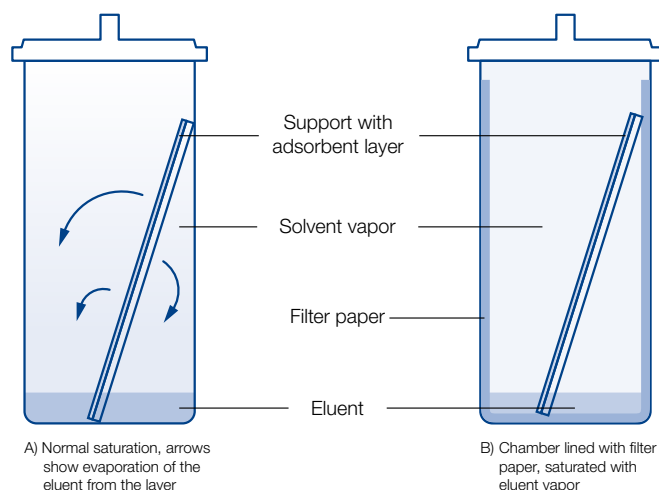

Evaluation of a thin layer chromatogram

Evaluation depends on the purpose of the chromatographic analysis. For qualitative determination often localization of substances is sufficient. This can be easily achieved by parallel runs with reference substances.

A parameter often used for qualitative evaluation is the R_f value (retention factor) or the 100-fold value hR_f . The R_f value is defined as follows:

$$R_f = \frac{\text{distance starting line} - \text{middle of spot}}{\text{distance starting line} - \text{solvent front}} = \frac{b}{a}$$

i.e. the R_f values are between 0 and 1, best between 0.1 and 0.8 (i.e. 10–80 for hR_f). If reproducible R_f values are to be obtained, it is essential that several parameters such as chamber saturation, composition of solvent mixtures, temperature etc. are strictly controlled.

Quantitative evaluation is possible by suitable calibration measurements. For this purpose either the area of a substance spot is measured or a photometric evaluation is performed directly on the layer. The latter procedure, however, requires a higher instrumental expense.

The following paragraphs describe the most frequently used methods for evaluation in TLC.

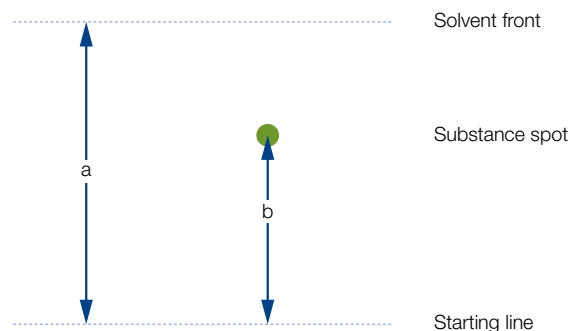

Qualitative detection

Qualitative evaluation is generally made directly on the TLC plate via characteristic R_f values of substances, i.e. the ratio of distance start – substance zone to distance start – solvent front and specific chemical reactions.

Visualization of separated substances

First of all it is necessary to recognize the position of a substance spot. Only in very few cases the sample is a dye which can be seen with the naked eye. Much more often for unspecific visualization substances can be viewed under UV light, since many substances show a UV absorption. If a fluorescent indicator is added to the layer, all substances absorbing in the respective region of wave length cause a quenching of the fluorescence, i.e. they appear as dark spots on the fluorescent layer. Customary fluorescent indicators are excited at 254 nm or (less frequently) at 366 nm with a mercury lamp. For our program of fluorescent indicators for TLC please see page 296.

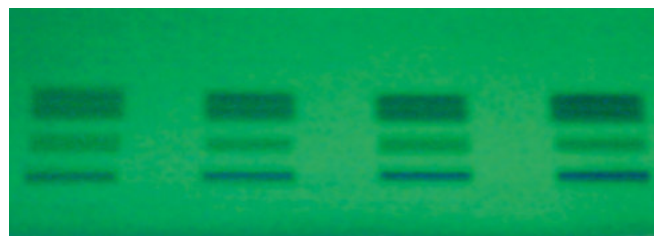

Quenching of the fluorescence

Identification of separated substances is possible via the R_f value compared to the pure compound, which is often applied simultaneously on the same plate.

For a number of compounds their native fluorescence can be used for visualization, which is excited by UV light (mostly long-wave UV) (e.g., aflatoxins). This allows not only determination of the R_f value, but often enables a further qualitative assignment.

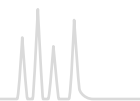

If these methods do not allow localization or characterization of a substance, post-chromatographic detection methods can be applied, chemical reactions on the TLC plate [15]. Quite un-specific reactions are iodine adsorption and the charring technique (spraying with sulfuric acid and heat treatment).

More reliable results are possible with specific reagents for spraying or dipping, which form colored or fluorescent compounds with the substances to be detected. Depending on the sensitivity of these reactions they are not only used for group or substance specific characterization (in addition to the R_f value) but also for quantification down to trace levels. As example take the ninhydrin reaction. Formation of a (usually red) zone with this detection method yields the information, that a certain group of substances, e.g., α -amino acids, are present. The R_f value allows further assignment to one or several single compounds.

For identification of a substance a combination of different detection methods can be useful. Thus almost all lipids can be converted to products with light green fluorescence by reaction with 2',7'-dichlorofluorescein. Adsorption of iodine vapor enables a differentiation between saturated and unsaturated lipids or lipids containing nitrogen. And finally the R_f value is a third means of identification.

Here are some general remarks concerning spraying: use all spray reagents under a fume hood. The developed, dried TLC plate or sheet is placed on a sheet of filter paper for spraying. Usually it is sufficient to fill the sprayer with about 5–10 mL solution. Spray from a distance of about 15 cm with the aid of a rubber ball or – if available – with pressurized air. It is always better to spray a layer twice very thinly and evenly (with intermediate drying), than to saturate the layer with excessive spray reagent. In the latter case spots tend to become diffuse. After visualization mark outlines of zones with a lead pencil, because some spots tend to fade after a while.

Especially for quantitative evaluation short dipping of the layer in the respective reagent solution is recommended. For this purpose automatic instruments are commercially available, which allow reproducible dipping.

When a substance is localized on the TLC plate (e.g., under UV), but not yet identified, TLC scanners allow recording of UV spectra of individual substance zones directly on the layer, or the zone is removed by scratching or cutting (for sheets), eluted and further analyzed, e.g., by FT-IR, RAMAN, NMR or mass spectroscopy.

Quantitative evaluation

Often TLC is considered to be only a semiquantitative analytical procedure. This is true for visual evaluation of spots, since the eye can only compare but not measure absolute values. If, however, a direct optical evaluation (“in situ” measurement) is performed on the TLC plate with a thin layer scanner, after measurement of calibration functions, exact quantitative results are possible. Commercial scanners offer many features such as evaluation in absorption and fluorescence, unattended programmed scanning of lanes, multi-wave length measurement, background correction, selectable base line for integration, recording of spectra,

evaluation of circular or anti-circular chromatograms with very high ease of operation. In addition to manual operation control by a computer is possible with respective data collection and storage. Usually wavelengths from 200 to 700 nm are available (visible and UV), e.g., all post-chromatographic (and of course all pre-chromatographic) visualization procedures are evaluated with the proper wavelength, which is determined with the instrument. Time requirements for all these possibilities are extremely low. Interlaboratory experiments with standard deviations of 2 % show how excellent results are obtainable [16].



TLC micro-sets introductory kits for science education

Beginner's set

- Features separations with simple developing solvents; samples are colored thus eliminating the need for visualization.
- All equipment needed is contained in the set.

Advanced sets F1, F2 and F3

- Require some experience and skill from the user: some of the samples have to be pretreated before separation, and for identification of substances spray reagents have to be used

TLC micro-set A for beginners

This kit contains all chemicals and accessories for the following separations:

- Separation of the fat-soluble (lipophilic)
Test dye mixture 1: butter yellow, indophenol, sudan blue II, sudan red G
- Separation of a mixture of anthraquinone dyes
Test dye mixture 2: blue 1, blue 3, green, green blue, red, violet 1, violet 2
- Separation of a mixture of food dyes
Test dye mixture 3: brilliant black BN (E151), fast red E, erythrosine (E127), yellow orange S (sunset yellow CFC, E110), naphthol red S, ponceau 4 R (E124), tartrazine (E102)
- Separation of dyes from felt tip pens

Contents of TLC micro-set A for beginners

- 1 manual
- 3 developing chambers
- 50 glass capillaries 1 μ L
- 1 spotting guide
- 2 felt tip pens
- 1 measuring cylinder 10 mL
- 50 polyester sheets 4 x 8 cm each of POLYGRAM®: SIL G/UV₂₅₄, Alox N/UV₂₅₄ and CEL 300
- 8 mL each of test dye mixture 1 (4 lipophilic dyes), test dyes sudan red G, and sudan blue II
- 8 mL each of test dye mixture 2 (7 anthraquinone dyes), test dyes blue 1 and violet 2
- 8 mL each of test dye mixture 3 (7 food dyes), test dyes yellow orange S, and brilliant black BN
- 100 mL each of toluene, toluene – cyclohexane (2:1, v/v), ethanol, 2.5 % sodium citrate solution, 25 % ammonia solution – 2-propanol (5:3, v/v)

Ordering information

Designation	Pack of	REF
TLC micro-set A for beginners*	1 kit	814000
Replacement parts for TLC micro-set A		
Test dye mixture 1*, solution of 4 lipophilic dyes in toluene (components see above)	8 mL	814001
Test dye mixture 2*, solution of 7 anthraquinone dyes in toluene – cyclohexane (2:1, v/v) (components see above)	8 mL	814002
Test dye mixture 3, aqueous solution of 7 food dyes (components see above)	8 mL	814003
Collection of 4 individual components of test dye mixture 1*	4 x 8 mL	814011
Collection of 7 individual components of test dye mixture 2*	7 x 8 mL	814012
Collection of 7 individual components of test dye mixture 3	7 x 8 mL	814013
Sodium citrate, 2.5 g in 100 mL bottle to fill up with distilled water	2.5 g	814029

* These products contain harmful substances which must be specially labeled as hazardous. For detailed information please see SDS.

Information about the advanced sets F1, F2 and F3 can be found on page 270 and page 271.



TLC micro-set F1

This kit contains all chemicals required for the separation of

- Amino acids (test mixture, consisting of alanine, arginine, tryptophan and valine)
- Amino acids in urine
- The heavy metal cations copper(II) and manganese(II)

Contents of TLC micro-set F1

1 manual, 50 glass capillaries 1 μ L
50 polyester sheets 4 x 8 cm each of POLYGRAM®: SIL G/UV₂₅₄ and CEL 300
100 mL each of *n*-butanol, ninhydrin spray reagent (0.2 % in ethanol), acetone, 25 % ammonia solution, rubeanic acid spray reagent
50 mL each of 50 % acetic acid, 18 % hydrochloric acid
8 mL each of the amino acid test mixture (see left), tryptophan and arginine reference solutions
8 mL each of the heavy metal cation test mixture (see left), Cu²⁺ and Mn²⁺ reference solutions

TLC micro-set F2

This kit contains all chemicals required

- For analysis of edible fats
- For analysis of fats and cholesterol in blood

Contents of TLC micro-set F2

1 manual, 50 glass capillaries 1 μ L
50 polyester sheets 4 x 8 cm POLYGRAM®: SIL G/UV₂₅₄
5 disposable pipettes 25 μ L
5 sample vials N 11 (1.5 mL) with PE caps and seals
3 sample vials 30 mL (for butter, margarine and edible oil)
100 mL each of cyclohexane and molybdato-phosphoric acid spray reagent
2 x 50 mL acetone with calibrated pipette
25 mL butan-2-one
8 mL cholesterol reference solution

TLC micro-set F3

This kit contains all chemicals required

- For separation of analgetics (pain relievers)
- For drug analysis as shown for cinchona bark

Contents of TLC micro-set F3

1 manual, 50 glass capillaries 1 μ L
50 polyester sheets 4 x 8 cm POLYGRAM®: SIL G/UV₂₅₄
5 Aspirin® tablets, 5 Thomapyrin® tablets
20 folded filters MN 615 1/4, 11 cm diameter
3 sample vials 8 mL (for Aspirin® sample, Thomapyrin® sample, cinchona bark extract), 5 g cinchona bark
100 mL each of ethanol, 2-propanol, toluene – diethyl ether je 100 mL Ethanol, 2-Propanol, Toluol – Diethylether (61:39, v/v), spray reagent for caffeine and spray reagent according to Dragendorff-Munier
50 mL each of iron(III) chloride solution and potassium hexacyanoferrate(III) solution, 30 mL ethyl acetate
25 mL each of 12.5 % ammonia solution and diethylamine
8 mL each of caffeine, paracetamol, quinine reference solutions

All experiments with TLC micro-sets F1–F3 require the materials kit (see TLC micro-set M on page 271).



Ordering information

Designation	Pack of	REF
TLC micro-set F1*	1 kit	814200
Refill reagents for TLC micro-set F1		
Amino acid test mixtures (components see previous page)	8 mL	814201
Collection of 4 individual components of the amino acid test mixture	4 x 8 mL	814202
Cation test mixture (components see previous page)	8 mL	814204
Collection of 2 individual components of the cation test mixture (Cu ²⁺ , Mn ²⁺)	2 x 8 mL	814205
TLC micro-set F2*	1 kit	814300
Refill reagents for TLC micro-set F2		
Cholesterol reference solution*	8 mL	814301
TLC micro-set F3*	1 kit	814400
Refill reagents for TLC micro-set F3		
Quinine reference solution*	8 mL	814405
Paracetamol reference solution*	8 mL	814406
Caffeine reference solution*	8 mL	814407
Refill packs TLC sheets for all TLC micro-sets		
TLC polyester sheets POLYGRAM® SIL G/UV ₂₅₄ , 4 x 8 cm	4 x 50	814025
TLC polyester sheets POLYGRAM® Alox N/UV ₂₅₄ , 4 x 8 cm	4 x 50	814026
TLC polyester sheets POLYGRAM® CEL 300, 4 x 8 cm	4 x 50	814027
TLC polyester sheets POLYGRAM® 4 x 8 cm: 100 x SIL G/UV ₂₅₄ ; 50 x Alox N/UV ₂₅₄ ; 50 x CEL 300	1 kit	814028

* These products contain harmful substances which must be specially labeled as hazardous. For detailed information please see SDS.

Accessories for TLC micro-sets can be found under TLC accessories on page 295.

Spray reagents can be found on page 296.



TLC micro-set M

This kit is prerequisite for the separations with kits F1 to F3. In addition, it serves as basic equipment for the individual study of further thin layer chromatographic experiments.

Contents of TLC micro-set M (materials kit)

- 2 x 50 glass capillaries 1 µL, 2 spotting guides
- 1 rubber cap for capillaries
- 1 measuring cylinder 10 mL
- 1 beaker 25 mL
- 2 developing chambers
- 1 glass laboratory sprayer with rubber bulb
- 1 plastic syringe 1 mL
- 20 sheets filter paper MN 713 (15 x 21 cm)
- 50 polyester sheets 4 x 8 cm each of POLYGRAM®: SIL G/UV₂₅₄, Alox N/UV₂₅₄ and CEL 300

Ordering information

Designation	Pack of	REF
TLC micro-set M (materials kit)	1 kit	814100

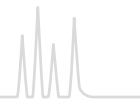

Advantages of MN plates and sheets for TLC

Continuous high quality

- Guaranteed by stringent production control including standardized lot tests, surface checks for roughness or cracks as well as hardness and adherence checks

Comprehensive range of phases for TLC / HPTLC

- There is no universal TLC plate which meets all possible types of analyses
- Our versatile range of TLC ready-to-use layers covers many different types of applications

Immediately ready for chromatographic separation

- Coatings or impregnations are not necessary

Homogeneous, smooth, well adhering layers

- An important criterion especially for reproducible quantitative evaluation



Electron microscope photograph of a cross section through a glass plate with silica layer (magnification x 500)

Adsorbents for MN plates and sheets for TLC

Classical adsorbents

- For ~ 80 % of all TLC separations silica 60 (mean pore diameter 60 Å = 6 nm) is used
- Other classical adsorbents are aluminum oxide, cellulose, kieselguhr, ion exchangers and polyamide

Special phases

- Modified silica, like C₁₈ (octadecyl-) cyano-, amino-, diol-, RP-2
- Special layers for specific separations, like PAH- or enantiomer separation

Particle size distribution and thickness of layer

- Are chosen to fit the given type of application (e.g., HPTLC, standard or preparative separations)
- Most MN ready-to-use layers are available with or without fluorescent indicator

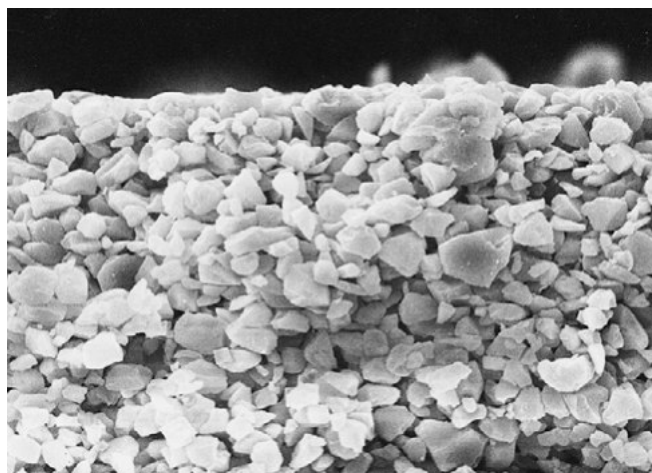

Electron microscope photograph of a cross section through an aluminum sheet with silica layer (magnification x 500)

Supports for ready-to-use layers for TLC

	Glass plates G	POLYGRAM® P	ALUGRAM® A / ALUGRAM® Xtra Ax
Physical properties of support materials			
Material	glass	polyester	aluminum
Thickness (approx.)	1.3 mm	0.2 mm	0.15 mm
Weight, packaging and storage requirements	high	low	low
Torsional strength	ideal	low	relatively high
Temperature stability	high	max. 185 °C	high
Susceptible to breakage	yes	no	no
Can be cut with scissors	no	yes	yes
Chemical resistance of support materials			
Against solvents	high	high	high
Against mineral acids and conc. ammonia	high	high	low
Stability of the binder system of NP plates in water			
Suitability for aqueous detection reagents	depending on phase	very suitable	ALUGRAM®: limited suitability; ALUGRAM® Xtra: very suitable

Summary of MN ready-to-use layers



Summary				
Phase	Support*	Layer		Page
Standard silica particle size 5–17 µm				
ADAMANT	G	silica 60, improved binder system, optimized particle size distribution		274
SIL G	G P A Ax	silica 60, standard grade		276
DURASIL	G	silica 60, special binder system		277
SILGUR	G Ax	silica 60 with kieselguhr concentrating zone		279
Unmodified silica for HPTLC particle size 2–10 µm				
Nano-SILGUR	G Ax	nano silica 60 with kieselguhr concentrating zone		279
Nano-ADAMANT	G	nano silica 60, improved binder system, optimized particle size distribution		281
Nano-SIL	G A Ax	nano silica 60, standard grade		281
Nano-DURASIL	G	nano silica 60, special binder system		282
Modified silica for HPTLC particle size 2–10 µm				
Nano-SIL C18-50/ Nano-SIL C18-100	G	nano silica with partial or complete C ₁₈ modification		283
RP-18 W/UV ₂₅₄	G A	nano silica with partial octadecyl modification, wettable with water		284
RP-2/UV ₂₅₄	G A	silanized silica = dimethyl-modified nano silica 60		284
Nano-SIL CN	G A	cyano-modified nano silica		285
Nano-SIL NH ₂	G A	amino-modified nano silica		286
Nano-SIL DIOL	G	diol-modified nano silica		287
Aluminum oxide				
Alox-25 / Alox N	G P A	aluminum oxide		288
Cellulose, unmodified and modified				
CEL 300	G P A	native fibrous cellulose MN 300		289
CEL 400	G P	microcrystalline cellulose MN 400 (AVICEL®)		289
CEL 300 PEI	P	polyethyleneimine-impregnated cellulose ion exchanger		290
CEL 300 AC	P	acetylated cellulose MN 300		290
POLYAMID-6				
POLYAMID-6	P	perlon = ε-polycaprolactame		290
Layers for special separations				
CHIRALPLATE	G	RP silica with Cu ²⁺ ions and chiral reagent, for enantiomer separation of amino acids		291
SIL N-HR	P	high purity silica 60, special binder system, higher gypsum content		291
SIL G-25 HR	G	high purity silica 60 with gypsum, recommended for aflatoxin analysis		292
SIL G-25 Tenside	G	silica G with ammonium sulfate for separation of surfactants		292
Nano-SIL PAH	G	nano silica with special impregnation for PAH analysis		292
IONEX-25 SA-Na	P	mixed layer of strongly acidic cation exchanger and silica		293
IONEX-25 SB-AC	P	mixed layer of strongly basic anion exchanger and silica		293
Alox / CEL-AC-Mix	G	mixed layer of aluminum oxide and acetylated cellulose		293
SILCEL-Mix	G	mixed layer of cellulose and silica		293

* G = Glass plates P = POLYGRAM® polyester sheets A = ALUGRAM® aluminum sheets Ax = ALUGRAM® Xtra aluminum sheets

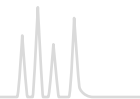

ADAMANT ^G unmodified standard silica layers

★ Key features

- Outstanding hardness and abrasion resistance due to an optimized binder system
- Increased separation efficiency due to an optimized particle size distribution
- High suitability for trace analysis resulting from a UV indicator with increased brilliance and a lownoise background of the layer

🔧 Technical characteristics

- Silica 60, mean pore size 60 Å, specific surface (BET) ~ 500 m²/g, specific pore volume 0.75 mL/g, particle size 5–17 µm

Separation of steroids

MN Appl. No. 402930

Layers: ADAMANT UV₂₅₄, SIL G/UV₂₅₄
 Sample: 0.1 % solution in CHCl₃
 Eluent: chloroform – methanol (97:3, v/v)
 Migration distance: ADAMANT 50 mm in 10 min, SIL G 57 mm in 10 min
 Detection: UV

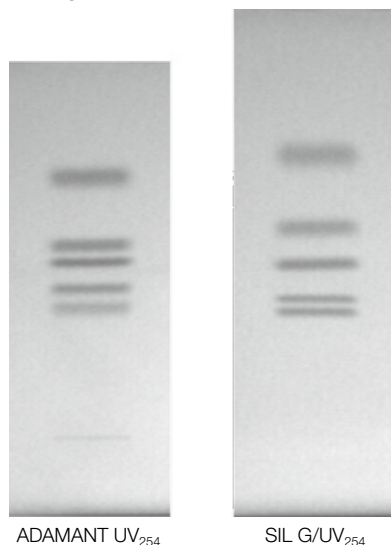

Substance	R _f ADAMANT	R _f SIL G
Cortisone	0.37	0.27
Corticosterone	0.43	0.30
Testosterone	0.50	0.39
Deoxycorticosterone	0.55	0.46
Progesterone	0.73	0.62

Separation of barbiturates

MN Appl. No. 402950

Layer: ADAMANT UV₂₅₄
 Sample volume: 1 µL
 Eluent: chloroform – acetone (95:5, v/v)
 Migration distance: 70 mm in 20 min
 Detection: UV

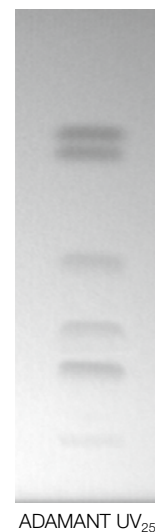

Substance	R _f
Thiamylal (0.5 %)	0.69
Thiopental (1.0 %)	0.65
Hexobarbital (5.0 %)	0.41
Pentobarbital (1.0 %)	0.26
Phenobarbital (1.0 %)	0.18

Ordering information

Plate size [cm]	2.5 x 7.5	5 x 10	5 x 10	5 x 20	10 x 10	10 x 20	20 x 20	Thickness of layer	Fluorescent indicator
Pack of [plates]	100	50	200	100	25	50	25		

Glass plates

ADAMANT		821040	821040.200		821050		821060	0.25 mm	–	
ADAMANT UV ₂₅₄		821005	821010	821010.200	821015	821020	821025	821030	0.25 mm	UV ₂₅₄



ALUGRAM® Xtra SIL G Ax unmodified standard silica layers on aluminum

★ Key features

- Outstanding wettability for precise colorization results, even with 100 % aqueous detection reagents
- Excellent separation efficiency and reproducibility from lot to lot
- Easy and reliable cutting due to an optimized binder system, no flaking of silica

🔧 Technical characteristics

- Silica 60, mean pore size 60 Å, specific surface (BET) ~ 500 m²/g, specific pore volume 0.75 mL/g, particle size 5–17 µm
- Binder: highly polymeric product, which is stable in almost all organic solvents and resistant towards aggressive visualization reagents, also completely stable in purely aqueous eluents

Separation of nutmeg ingredients

MN Appl. No. 403590

Layer: ALUGRAM® Xtra SIL G UV₂₅₄
 Sample: shake 1.0 g freshly powdered drug for 3 min with 4 mL methanol and filter; apply 10 µL
 Eluent: toluene – ethyl acetate (95:5, v/v)
 Migration distance: 15 cm
 Detection: 254 nm: underivatized
 daylight and 366 nm: spray with 5 % ethanolic sulfuric acid, 1 % vanillic acid and heat to 105 °C

The chromatograms show the following zones with increasing R_f values: linalool (bluish grey), eugenol (yellowish brown), myristicin (reddish brown), and anethole (pink-violet). Other colored zones may appear.

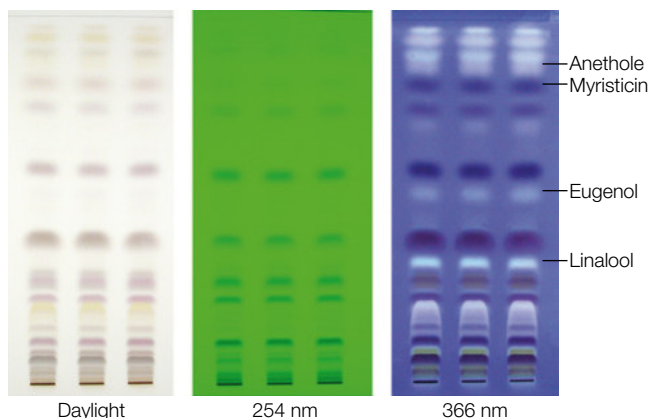

Ordering information

Plate size [cm]	2.5 x 7.5	4 x 8	5 x 7.5	5 x 10	5 x 20	10 x 20	20 x 20	Thickness of layer	Fluorescent indicator
Pack of [plates]	200	50	20	50	50	20	25		

ALUGRAM® Xtra aluminum sheets

SIL G			818230.20	818261	818232		818233	0.20 mm	–
SIL G/UV ₂₅₄	818329	818331	818330.20	818360	818332	818362	818333	0.20 mm	UV ₂₅₄

Further application examples can be found online in our application database at www.mn-net.com/apps



Unmodified TLC silica layers



SIL G G P A unmodified standard silica layers

Technical characteristics

- Silica 60, mean pore size 60 Å, specific surface (BET) ~ 500 m²/g, specific pore volume 0.75 mL/g, particle size 5–17 µm
- Thickness of layer for analytical plates 0.25 mm, for preparative plates 0.5 and 1 mm; for 2 mm preparative layers a slightly coarser material is used
- Indicators: manganese activated zinc silicate with green fluorescence for short-wave UV (254 nm); special inorganic fluorescent pigment with blue fluorescence for long-wave UV (366 nm)
- Binders: highly polymeric products, which are stable in almost all organic solvents and resistant towards aggressive visualization reagents; binder system for POLYGRAM® sheets is also completely stable in purely aqueous eluents

Ordering information

Glass plates

Plate size [cm]	2.5 x 7.5	5 x 10	5 x 10	5 x 20	10 x 10	10 x 20	20 x 20	Thickness of layer
Pack of [plates]	100	50	200	100	25	50	25	
SIL G-25		809017	809017.200	809011		809012	809013	0.25 mm
SIL G-25 UV ₂₅₄	809028.100	809027	809027.200	809021	809020	809022	809023	0.25 mm
SIL G-25 UV ₂₅₄₊₃₆₆				809121		809122	809123	0.25 mm

Glass plates

Pack of [plates]	(preparative TLC)		20	
SIL G-50			809051	0.50 mm
SIL G-50 UV ₂₅₄			809053	0.50 mm

Glass plates

Pack of [plates]	(preparative TLC)		15	
SIL G-100			809061	1.00 mm
SIL G-100 UV ₂₅₄			809063	1.00 mm

Glass plates

Pack of [plates]	(preparative TLC)		12	
SIL G-200			809073	2.00 mm
SIL G-200 UV ₂₅₄			809083	2.00 mm

POLYGRAM® polyester sheets

Plate size [cm]	2.5 x 7.5	4 x 8		5 x 20		20 x 20	40 x 20	
Pack of [plates]	200	50		50		25	25	
SIL G	805902	805032		805012		805013	805014	0.20 mm
SIL G/UV ₂₅₄	805901	805021		805022		805023	805024	0.20 mm
SIL G/UV ₂₅₄					roll 500 x 20 cm	805017		0.20 mm

ALUGRAM® aluminum sheets

Plate size [cm]	2.5 x 7.5	4 x 8	5 x 7.5	5 x 10	5 x 20	10 x 20	20 x 20	
Pack of [plates]	200	50	20	50	50	20	25	
SIL G			818030.20	818161	818032	818163	818033	0.20 mm
SIL G/UV ₂₅₄	818129	818131	818130.20	818160	818132	818162	818133	0.20 mm

Further application examples can be found online in our application database at www.mn-net.com/apps



Unmodified TLC silica layers



DURASIL ^G unmodified standard silica layers

🔧 Technical characteristics

• Silica 60, mean pore size 60 Å, specific surface (BET) ~ 500 m²/g, specific pore volume 0.75 mL/g, particle size 5–17 µm

• Hard, water-resistant and wettable layers due to a special binder system

Ordering information

Plate size [cm]	5 x 10	5 x 10	5 x 20	10 x 20	20 x 20	Thickness of layer	Fluorescent indicator
Pack of [plates]	50	200	100	50	25		

Glass plates

DURASIL-25				812003	812004	0.25 mm	–
DURASIL-25 UV ₂₅₄	812005	812005.200	812006	812007	812008	0.25 mm	UV ₂₅₄



The most TLC layers are available as glass plate, polyester- or aluminum sheet (also see page 272 and 273).



MN TLC pre-coated layers – qualitative and individual tailored

Kieselguhr zone

- For rapid sample application
- Because kieselguhr is completely inert towards a large number of compounds, the samples always form a narrow band at the interface of the two adsorbents, irrespective of shape, size or position of the spots in the concentrating zone. Separation then takes place in the silica layer.

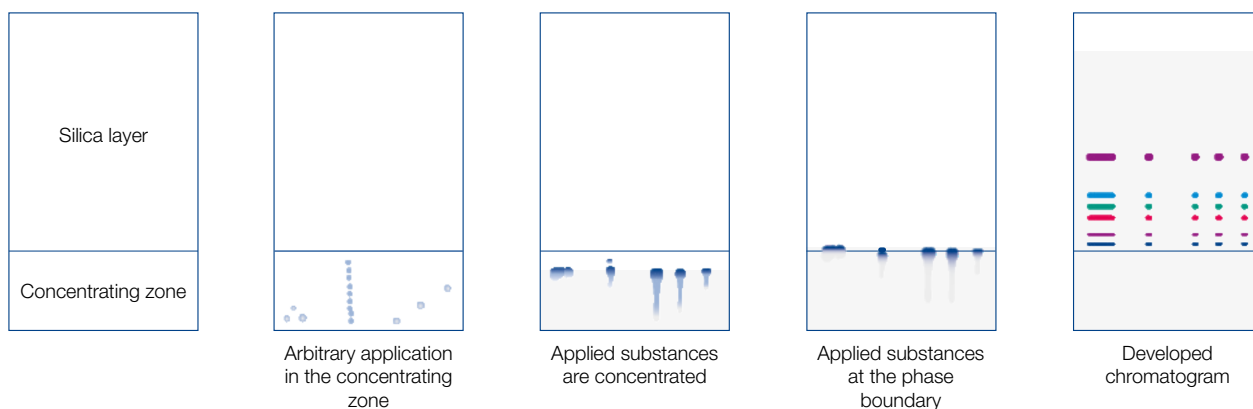



Silica layers with concentrating zone



SILGUR G Ax unmodified standard silica layers with concentrating zone

Technical characteristics

- Silica 60, mean pore size 60 Å, specific surface (BET) ~ 500 m²/g, specific pore volume 0.75 mL/g, particle size 5–17 µm
- Kieselguhr zone for rapid sample application (see page 278)
- Channel-plate with 19 channels help to prevent cross contamination by separating several samples
- More samples can be separated on a plate, and spot areas can be more easily determined

Ordering information

Plate size [cm]	10 x 20	20 x 20	Thickness of layer	Fluorescent indicator
Glass plates				
Pack of [plates]	50	25		
SILGUR-25	810012	810013	0.25 mm	–
SILGUR-25 UV ₂₅₄	810022	810023	0.25 mm	UV ₂₅₄
Channel-Plates				
Pack of [plates]		25		
SILGUR-25-C UV ₂₅₄		810123	0.25 mm	UV ₂₅₄
ALUGRAM® Xtra aluminum sheets				
Pack of [plates]	20	25		
SILGUR	818412	818413	0.20 mm	–
SILGUR UV ₂₅₄	818422	818423	0.20 mm	UV ₂₅₄

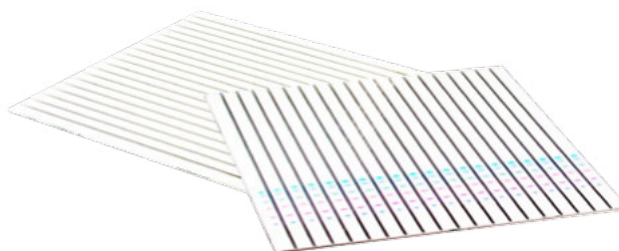

Nano-SILGUR G Ax unmodified HPTLC silica layers with concentrating zone

Technical characteristics

- Nano silica 60, pore size 60 Å, specific surface (BET) ~ 500 m²/g, mean specific pore volume 0.75 mL/g, particle size 2–10 µm
- Kieselguhr zone for rapid sample application (see page 278)

Ordering information

Plate size [cm]	10 x 10	Thickness of layer	Fluorescent indicator
Pack of [plates]	25		
Glass plates			
Nano-SILGUR-20	811032	0.20 mm	–
Nano-SILGUR-20 UV ₂₅₄	811042	0.20 mm	UV ₂₅₄
ALUGRAM® Xtra aluminum sheets			
Nano-SILGUR	818432	0.20 mm	–
Nano-SILGUR UV ₂₅₄	818442	0.20 mm	UV ₂₅₄



Sharper separation by nano silica

Nano silica for HPTLC

- Narrow fractionation of the silica particles allows theoretical plate heights, which are one order of magnitude smaller than on standard silica layers.

Advantages

- Shorter migration distances
- Lower amount of samples required
- Increased detection sensitivity with equal selectivity
- Less developing time

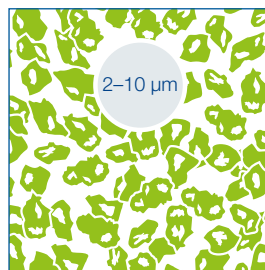

Nano silica

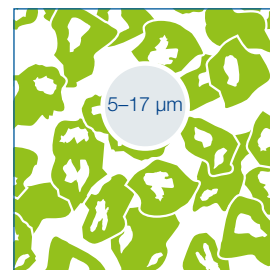

Standard silica

Comparison of ADAMANT and Nano-ADAMANT plates for separation of anthraquinone dyes

Layers: A) ADAMANT
B) Nano-ADAMANT
Sample: 1 μ L, about 0.1 %
Eluent: toluene – cyclohexane (4:3, v/v)
Migration time: A) 30 min, B) 15 min

Peaks:
1. Blue 3
2. Violet 2
3. Red
4. Green
5. Blue 1
6. Greenish blue
7. Violet 1

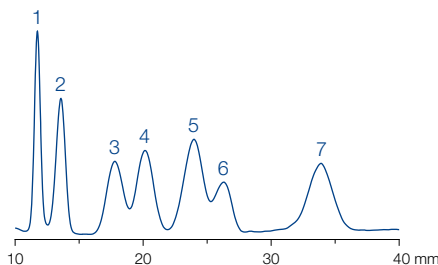
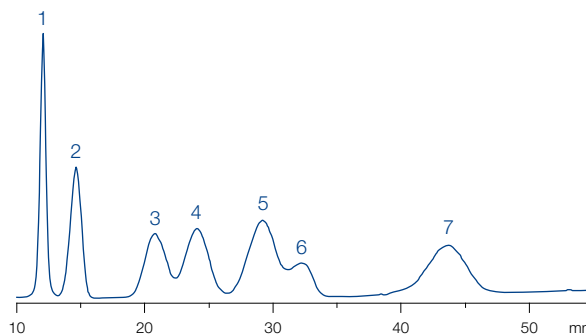



Unmodified HPTLC silica layers



Nano-ADAMANT ^G unmodified HPTLC silica layers

★ Key features

- Outstanding hardness and abrasion resistance due to an optimized binder system
- Increased separation efficiency due to an optimized particle size distribution
- High suitability for trace analyses resulting from a UV indicator with increased brilliance and a lownoise background of the layer

🔧 Technical characteristics

- Nano silica 60, mean pore size 60 Å, specific surface (BET) ~ 500 m²/g, specific pore volume 0.75 mL/g, particle size 2–10 µm

Ordering information

Plate size [cm]	10 x 10	10 x 20	Thickness of layer	Fluorescent indicator
Pack of [plates]	25	50		

Glass plates

Nano-ADAMANT	821140	821150	0.20 mm	–
Nano-ADAMANT UV ₂₅₄	821110	821120	0.20 mm	UV ₂₅₄

Nano-SIL ^{G Ax A} unmodified HPTLC silica layers

🔧 Technical characteristics

- Nano silica 60, mean pore size 60 Å, specific surface (BET) ~ 500 m²/g, specific pore volume 0.75 mL/g, particle size 2–10 µm
- Indicator: manganese activated zinc silicate with green fluorescence for short-wave UV (254 nm)
- Binder: highly polymeric product, which is stable in almost all organic solvents and resistant towards aggressive visualization reagents

Ordering information

Plate size [cm]	5 x 5	5 x 20	10 x 10	10 x 20	20 x 20	Thickness of layer	Fluorescent indicator
Pack of [plates]	100	50	25	50	25		

Glass plates

Nano-SIL-20	811011	811012	811013	0.20 mm	–
Nano-SIL-20 UV ₂₅₄	811021	811022	811023	0.20 mm	UV ₂₅₄

ALUGRAM[®] Xtra aluminum sheets

Nano-SIL G	818240	818241	0.20 mm	–
Nano-SIL G/UV ₂₅₄	818342	818343	0.20 mm	UV ₂₅₄

ALUGRAM[®] aluminum sheets

Nano-SIL G	818141	0.20 mm	–
Nano-SIL G/UV ₂₅₄	818143	0.20 mm	UV ₂₅₄



Unmodified HPTLC silica layers



Nano-DURASIL ^G unmodified HPTLC silica layers

Technical characteristics

- Nano silica 60, mean pore size 60 Å, specific surface (BET) ~ 500 m²/g, specific pore volume 0.75 mL/g, particle size 2–10 µm
- Indicator: manganese activated zinc silicate with green fluorescence for short-wave UV (254 nm)
- Hard, water-resistant and wettable layers due to a special binder system
- Different selectivity compared to ADAMANT and SIL-G plates no reversed phase tendency, more polar than Nano-SIL

Ordering information

Plate size [cm]	10 x 10	10 x 20	Thickness of layer	Fluorescent indicator
Pack of [plates]	25	50		

Glass plates

Nano-DURASIL-20	812010	812011	0.20 mm	–
Nano-DURASIL-20 UV ₂₅₄	812013	812014	0.20 mm	UV ₂₅₄



MACHEREY-NAGEL CHROMABOND[®] SPE and Flash products

High-performance products for sample preparation

- Comprehensive range of RP- and normal phases as well as ion exchangers
- Polymer and silica based phases
- Phases for special applications like food or environmental analysis
- SPE polypropylene columns and cartridges, MULTI 96 plates and SPE accessories
- High throughput SPE
- Flash chromatography cartridges



More information from page 9 onwards as well as online at www.mn-net.com/chroma



Nano-SIL C18 ^G octadecyl-modified HPTLC silica layers

Technical characteristics

- Nano silica 60, mean pore size 60 Å, specific surface (BET) ~ 500 m²/g, specific pore volume 0.75 mL/g, pH stability 2–10, particle size 2–10 µm
- Indicator: acid-resistant product with a pale blue fluorescence for short-wave UV (254 nm), UV-absorbing substances appear as dark-blue to black spots on a light-blue background

Modification

- Partial (50 %) or complete (100 %) octadecyl modification, carbon content 7.5 and 14 %, respectively
- Order of polarity: silica > DIOL > NH₂ > CN > RP-2 > C18-50 > RP-18 W > C18-100

Recommended application

- Reversed phase separation mode with eluents from anhydrous solvents to mixtures with high concentrations of water (see table and figure below)
- Alkaloids, amino acids, preservatives, optical brighteners, barbiturates, polycyclic aromatic hydrocarbons (PAH), drugs, peptides, flavonoids, phenols, indole derivatives, steroids

Ordering information

Plate size [cm]	10 x 10	Thickness of layer	Fluorescent indicator
Pack of [plates]	25		

Glass plates

Nano-SIL C18-50	50 % silanized	81 1054	0.20 mm	–
Nano-SIL C18-50 UV ₂₅₄	50 % silanized	81 1064	0.20 mm	UV ₂₅₄
Nano-SIL C18-100	100 % silanized	81 1052	0.20 mm	–
Nano-SIL C18-100 UV ₂₅₄	100 % silanized	81 1062	0.20 mm	UV ₂₅₄

Eluent	v/v	Migration distances [mm/15 min]		
		C18-50	C18-100	RP-18 W
Methanol – H ₂ O	2:1	57	45	44
	1:1	52	21	40
	1:2	50	0	43
	1:3	40	0	45
	1:4	30	0	46
Acetonitrile – H ₂ O	0:1	0	0	54
	2:1	62	46	66
	1:1	52	30	54
	1:2	51	27	46
	1:3	48	15	44
Trichloromethane	1:9	20	0	42
		68	64	71

Migration of C18-50 and C18-100 silica layers as compared to RP-18 W plates

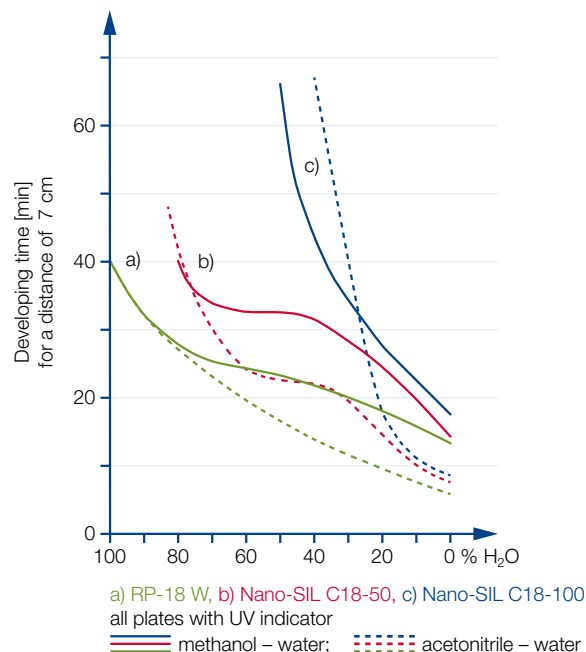

Elution properties of MN RP plates in mixtures of methanol – water and acetonitrile – water

Further application examples can be found online in our application database at www.mn-net.com/apps



Modified silica layers



RP-18 W/UV₂₅₄ G A octadecyl-modified HPTLC silica layers

🔧 Technical characteristics

- Nano silica 60, mean pore size 60 Å, specific surface (BET) ~ 500 m²/g, specific pore volume 0.75 mL/g, particle size 2–10 µm, for preparative plates (1 mm thickness of layer) standard silica 60, pH stability 2–10, particle size 5–17 µm
- Indicator: acid-resistant product with a pale blue fluorescence for short-wave UV (254 nm), UV-absorbing substances appear as dark-blue to black spots on a light-blue background

🔧 Modification

- Partial octadecyl (C₁₈) modification, wettable with water, carbon content 14 %
- Order of polarity: silica > DIOL > NH₂ > CN > RP-2 > C18-50 > RP-18 W > C18-100

✅ Recommended application

- NP or RP separation with eluents from anhydrous solvents to mixtures with high concentrations of water (see table and figure on previous page), relative polarity of the eluent determines the polarity of the layer
- Aminophenols, barbiturates, preservatives, nucleobases, polycyclic aromatic hydrocarbons, steroids, tetracyclines, plasticizers (phthalates)

Ordering information

Plate size [cm]	4 x 8	5 x 10	5 x 20	10 x 10	10 x 20	20 x 20	Thickness of layer	Fluorescent indicator
-----------------	-------	--------	--------	---------	---------	---------	--------------------	-----------------------

Glass plates

Pack of [plates]		50	25	50	25		
RP-18 W/UV ₂₅₄		811073	811075	811072	811071	0.25 mm	UV ₂₅₄
Pack of [plates] (preparative TLC)					15		
RP-18 W/UV ₂₅₄					811074	1.00 mm	UV ₂₅₄

ALUGRAM® aluminum sheets

Pack of [plates]	50	50	50	25	25		
RP-18 W/UV ₂₅₄	818144	818152	818145	818147	818146	0.15 mm	UV ₂₅₄

RP-2/UV₂₅₄ G A "silanized silica" = dimethyl-modified standard silica layers

🔧 Technical characteristics

- Silica 60, mean pore size 60 Å, specific surface (BET) ~ 500 m²/g, specific pore volume 0.75 mL/g, pH stability 2–10, particle size 5–17 µm
- Indicator: acid-resistant product with a pale blue fluorescence for short-wave UV (254 nm), UV-absorbing substances appear as dark-blue to black spots on a light-blue background

🔧 Modification

- Silanized silica with dimethyl modification, carbon content 4 %
- Order of polarity: silica > DIOL > NH₂ > CN > RP-2 > C18-50 > RP-18 W > C18-100

✅ Recommended application

- Normal phase or reversed phase separation modes with purely organic, organic - aqueous or purely aqueous eluents
- Active plant constituents, steroids

Ordering information

Plate size [cm]	10 x 20	20 x 20	Thickness of layer	Fluorescent indicator
-----------------	---------	---------	--------------------	-----------------------

Glass plates

RP-2/UV ₂₅₄	811081	811082	0.25 mm	UV ₂₅₄
------------------------	--------	--------	---------	-------------------

ALUGRAM® aluminum sheets

RP-2/UV ₂₅₄		818171	0.15 mm	UV ₂₅₄
------------------------	--	--------	---------	-------------------



Nano-SIL CN G A cyano-modified HPTLC silica layers

🔧 Technical characteristics

- Nano silica 60, mean pore size 60 Å, specific surface (BET) ~ 500 m²/g, specific pore volume 0.75 mL/g, pH stability 2–8, particle size 2–10 μm
- Indicator: acid-resistant product with a pale blue fluorescence for short-wave UV (254 nm), UV-absorbing substances appear as dark-blue to black spots on a light-blue background

🔧 Modification

- Cyanopropyl modification, carbon content 5.5 %
- Order of polarity: silica > DIOL > NH₂ > CN > RP-2 > C18-50 > RP-18 W > C18-100

✅ Recommended application

- NP or RP separation modes depending on the polarity of the developing solvent (see figure below)
- Steroid hormones, phenols, preservatives

R_f values of different steroids as a function of eluent composition

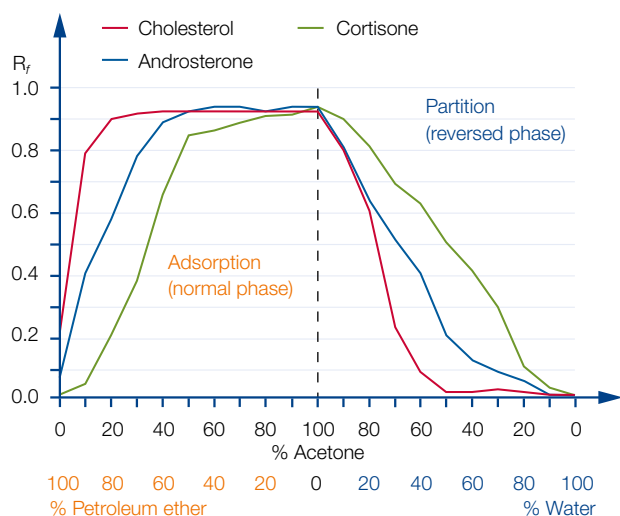

Layer: Nano-SIL CN/UV

Polarity of the eluent governs the type of separation mechanism:

Eluent system petroleum ether (PE) – acetone (NP mode)

the higher the concentration of PE, the stronger are the adsorptive interactions of the steroids with the stationary phase

Eluent system acetone – water (RP mode)

the sequence of elution of the steroids is reversed, the most nonpolar compounds are most strongly retained

Separation of preservatives

MN Appl. No. 401440

Layer: Nano-SIL CN/UV
 Sample volume: 400 nL
 Eluent: ethanol – water – glacial acetic acid (20:80:0.2) with 0.1 mol/L tetraethylammonium chloride
 Migration distance: 73 mm in 30 min
 Detection: TLC scanner, UV 254 nm

Peaks:

1. Propyl p-hydroxybenzoate
2. Ethyl p-hydroxybenzoate
3. Methyl p-hydroxybenzoate
4. Benzoic acid
5. Sorbic acid

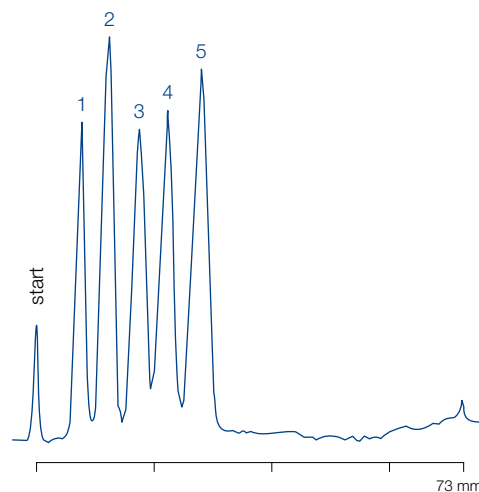

Ordering information

Plate size [cm]	4 x 8	10 x 10	10 x 20	Thickness of layer	Fluorescent indicator
Pack of [plates]	50	25	25		

Glass plates

Nano-SIL CN/UV	811115	811116	0.20 mm	UV ₂₅₄
----------------	--------	--------	---------	-------------------

ALUGRAM® aluminum sheets

Nano-SIL CN/UV	818184		0.15 mm	UV ₂₅₄
----------------	--------	--	---------	-------------------



Nano-SIL NH₂ G A amino-modified HPTLC silica layers

✔ Technical characteristics

- Nano silica 60, mean pore size 60 Å, specific surface (BET) ~ 500 m²/g, specific pore volume 0.75 mL/g, pH stability 2–8, particle size 2–10 µm
- Indicator: acid-resistant product with a pale blue fluorescence for short-wave UV (254 nm), UV-absorbing substances appear as dark-blue to black spots on a light-blue background

✔ Modification

- Aminopropyl modification, carbon content 3.5 %
- Order of polarity: silica > DIOL > NH₂ > CN > RP-2 > C18-50 > RP-18 W > C18-100
- Layer can be wetted equally well with pure water as with organic solvents

✔ Recommended application

- Vitamins, sugars, steroids, purine derivatives, xanthenes, phenols, nucleotides and pesticides

Influence of eluent composition on the separation of nucleotides

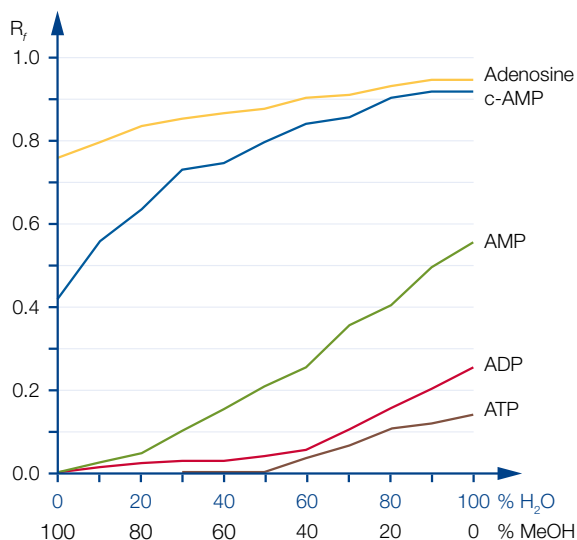

Layer: Nano-SIL NH₂/UV
 Eluent: MeOH – H₂O according to fig. + 0.18 mol/L NaCl
 Migration distance: 7 cm

c-AMP, AMP: adenosine monophosphate
 ADP: adenosine diphosphate
 ATP: adenosine triphosphate

Separation of sugars

MN Appl. No. 401590

Layer: Nano-SIL NH₂/UV
 Sample volume: 0.5 µL
 Eluent: ethyl acetate – pyridine – water – glacial acetic acid (60:30:10:5, v/v/v/v)
 Migration distance: 80 mm in 45 min, double development
 Detection: dry layer at 160 °C for 5 min, TLC scanner, UV 254 nm

Peaks (0.1 % each):

1. Lactose
2. Saccharose
3. Galactose
4. Glucose
5. Fructose
6. Arabinose
7. Xylose
8. Ribose

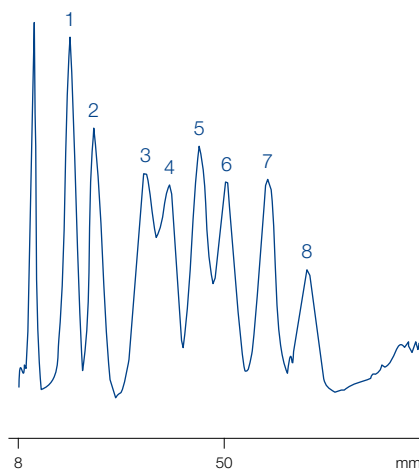

Ordering information

Plate size [cm]	4 x 8	10 x 10	10 x 20	Thickness of layer	Fluorescent indicator
Pack of [plates]	50	25	25		

Glass plates

Nano-SIL NH ₂ /UV	811111	811112	0.20 mm	UV ₂₅₄
------------------------------	--------	--------	---------	-------------------

ALUGRAM® aluminum sheets

Nano-SIL NH ₂ /UV	818182		0.15 mm	UV ₂₅₄
------------------------------	--------	--	---------	-------------------

Further application examples can be found online in our application database at www.mn-net.com/apps



Nano-SIL DIOL G diol-modified HPTLC silica layers

🔧 Technical characteristics

- Nano silica 60, mean pore size 60 Å, specific surface (BET) ~ 500 m²/g, specific pore volume 0.75 mL/g, pH stability 2–8, particle size 2–10 µm
- Indicator: acid-resistant product with a pale blue fluorescence for short-wave UV (254 nm), UV-absorbing substances appear as dark-blue to black spots on a light-blue background

🔧 Modification

- Diol modification, carbon content 5.5 %
- Order of polarity: silica > DIOL > NH₂ > CN > RP-2 > C18-50 > RP-18 W > C18-100
- Layer can be wetted equally well with pure water as with organic solvents

✅ Recommended application

- Steroids, pesticides and plant constituents
- For critical separations an alternative to silica
- Since it is less sensitive to the water content of the environment, leads to more reproducible results compared to silica

Separation of herbicides

MN Appl. No. 401950

Layer: Nano-SIL DIOL/UV
 Sample volume: 2 µL
 Eluent: petroleum ether (40–60 °C) – acetone (80:20, v/v)
 Migration distance: 70 mm
 Detection: TLC scanner, 230 nm

Peaks:
 (0.07 % each in methanol)

1. Metoxuron
2. Monuron
3. Metobromuron

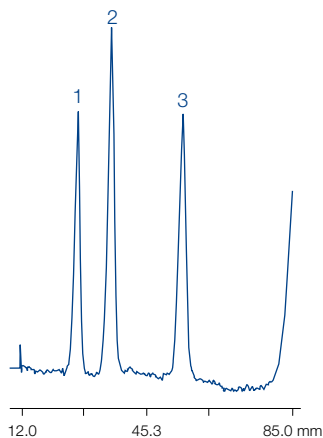

Ordering information

Plate size [cm]	10 x 10	Thickness of layer	Fluorescent indicator
Pack of [plates]	25		

Glass plates

Nano-SIL DIOL/UV	811120	0.20 mm	UV ₂₅₄
------------------	--------	---------	-------------------

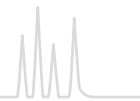

Alox G P A aluminum oxide layers

🔧 Technical characteristics

- Aluminum oxide, mean pore size 60 Å, specific surface (BET) ~ 200 m²/g
- Inert organic binder
- Indicator: manganese-activated zinc silicate

✅ Recommended application

- Terpenes, alkaloids, steroids, aliphatic and aromatic compounds
- We recommend to activate aluminum oxide layers before use by heating 10 minutes at 120 °C

Separation of bisadducts of fullerenes

MN Appl. No. 401930

F. Djojo, A. Hirsch, Chem. Eur. J. 4 (1998), 344–356

Layer: ALUGRAM® Alox N/UV₂₅₄
 Eluent: toluene – ethyl acetate (95:5, v/v)
 Detection: UV, 254 nm

Compound	R _f values
Bis[bis(4-phenyloxazolin)methane]fullerene 1	0.14
Bis[bis(4-phenyloxazolin)methane]fullerene 2	0.26

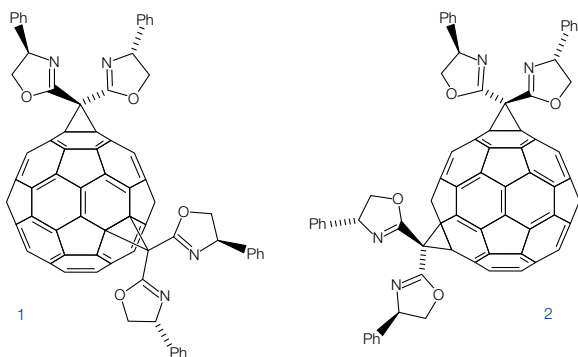

Separation of lipophilic dyes

MN Appl. No. 403010

Layer: Alox-25 UV₂₅₄
 Sample volume: 1000 nL
 Eluent: toluene – cyclohexane (2:1, v/v)
 Migration distance: 108 mm in 15 min
 Detection: TLC scanner, UV 254 nm

Peaks:

1. Indophenol
2. Sudan red G
3. Sudan blue II
4. Butter yellow

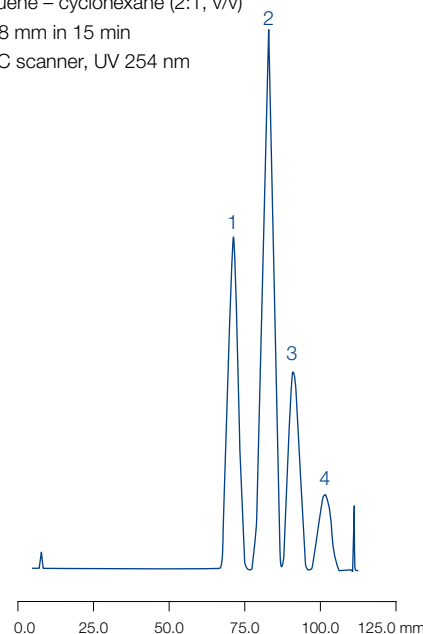

Ordering information

Plate size [cm]	4 x 8	5 x 20	20 x 20	Thickness of layer	Fluorescent indicator
Glass plates					
Pack of [plates]		100	25		
Alox-25 UV ₂₅₄		807021	807023	0.25 mm	UV ₂₅₄
Pack of [plates] (preparative TLC)					
Alox-100 UV ₂₅₄			807033	1.00 mm	UV ₂₅₄
POLYGRAM® polyester sheets					
Pack of [plates]	50	50	25		
Alox N/UV ₂₅₄	802021	802022	802023	0.20 mm	UV ₂₅₄
ALUGRAM® aluminum sheets					
Pack of [plates]		50	25		
Alox N/UV ₂₅₄		818024	818023	0.20 mm	UV ₂₅₄

Further application examples can be found online in our application database at www.mn-net.com/apps

Cellulose MN 300 G P A native fibrous cellulose layers

 Technical characteristics

- Fiber length (95 %) 2–20 µm, average degree of polymerization 400–500, specific surface acc. to Blaine 15 000 cm²/g, ≤ 20 ppm Fe, 6 ppm Cu, 7 ppm P; CH₂Cl₂- extract ≤ 0.25 %; residue on ignition at 850 °C ≤ 1500 ppm

Recommended application

- Partition chromatography of polar substances such as amino acids, carboxylic acids or carbohydrates

Ordering information

Plate size [cm]	4 x 8	5 x 20	20 x 20	Thickness of layer	Fluorescent indicator
Glass plates					
Pack of [plates]			25		
CEL 300-10			808013	0.10 mm	–
CEL 300-10 UV ₂₅₄			808023	0.10 mm	UV ₂₅₄
CEL 300-25			808033	0.25 mm	–
CEL 300-25 UV ₂₅₄			808043	0.25 mm	UV ₂₅₄
Pack of [plates] (preparative TLC)			20		
CEL 300-50			808053	0.50 mm	–
CEL 300-50 UV ₂₅₄			808063	0.50 mm	UV ₂₅₄
POLYGRAM® polyester sheets					
Pack of [plates]	50	50	25		
CEL 300	801011		801013	0.10 mm	–
CEL 300 UV ₂₅₄		801022	801023	0.10 mm	UV ₂₅₄
ALUGRAM® aluminum sheets					
Pack of [plates]	50	50	25		
CEL 300	818155		818153	0.10 mm	–
CEL 300 UV ₂₅₄		818157	818156	0.10 mm	UV ₂₅₄

Cellulose MN 400 (AVICEL®) G P microcrystalline cellulose layers

 Technical characteristics

- Prepared by hydrolysis of high purity cellulose with HCl, average degree of polymerization 40–200

Recommended application

- Carboxylic acids, lower alcohols, urea and purine derivatives

Ordering information

Plate size [cm]	10 x 20	20 x 20	Thickness of layer	Fluorescent indicator
Pack of [plates]	50	25		
Glass plates				
CEL 400-10	808072	808073	0.10 mm	–
POLYGRAM® polyester sheets				
CEL 400		801113	0.10 mm	–
CEL 400 UV ₂₅₄		801123	0.10 mm	UV ₂₅₄



Cellulose MN 300 PEI P PEI-impregnated cellulose ion exchange layers

🔧 Technical characteristics

- Fibrous cellulose impregnated with polyethyleneimine

✅ Recommended application

- Analysis of nucleic acids, and of mutagenic substances with the ³²P postlabelling procedure

Ordering information

Plate size [cm]	20 x 20	Thickness of layer	Fluorescent indicator
Pack of [plates]	25		

POLYGRAM® polyester sheets

CEL 300 PEI	801053	0.10 mm	–
CEL 300 PEI/UV ₂₅₄	801063	0.10 mm	UV ₂₅₄

Cellulose MN 300 AC P acetylated cellulose layers

🔧 Technical characteristics

- Fibrous cellulose with 10 % content of acetylated cellulose for reversed phase chromatography

✅ Recommended application

- Reversed phase chromatography

Ordering information

Plate size [cm]	Acetyl content	20 x 20	Thickness of layer	Fluorescent indicator
Pack of [plates]		25		

POLYGRAM® polyester sheets

CEL 300 AC-10 %	10 %	801033	0.10 mm	–
-----------------	------	--------	---------	---

Polyamid-6 P ε-polycaprolactame layers

🔧 Technical characteristics

- Polyamide 6 = nylon 6 = perlon = ε-aminopolycaprolactame
- Separation mechanism based on hydrogen bonds to amide groups of the polymer matrix as well as on ionic, dipole and electron donor-acceptor interactions

✅ Recommended application

- Natural compounds, phenols, carboxylic acids, aromatic nitro compounds and especially amino acids

Ordering information

Plate size [cm]	5 x 20	20 x 20	Thickness of layer	Fluorescent indicator
Pack of [plates]	50	25		

POLYGRAM® polyester sheets

POLYAMID-6	803012	803013	0.10 mm	–
POLYAMID-6 UV ₂₅₄	803022	803023	0.10 mm	UV ₂₅₄

Further application examples can be found online in our application database at www.mn-net.com/apps



CHIRALPLATE ^G special layer enantiomer separation

Technical characteristics

- Reversed phase nano silica impregnated with Cu²⁺ ions and a chiral selector (proline derivative)
- Separation based on ligand exchange, i.e. formation of ternary mixed-ligand complexes with the Cu(II) ions, differences in the stability of the diastereomeric complexes cause chromatographic separation

Recommended application

- Enantiomer separation of amino acids, *N*-methylamino acids, *N*-formylamino acids, α -alkylamino acids, thiazolidine derivatives, dipeptides, lactones, α -hydroxycarboxylic acids

Enantiomer separation of amino acids

MN Appl. No. 400520

Quantitative determination (remission location curves) of TLC-separated enantiomers of *tert.*-leucine:

Layer: CHIRALPLATE
 Eluent: methanol – water (10:80, v/v)
 Detection: dip in 0.3 % ninhydrin solution
 quantification with scanner, 520 nm

- a) L-*tert.*-leucine
 b) L-*tert.*-leucine + 0.1 % D-*tert.*-leucine
 c) L-*tert.*-leucine + 1 % D-*tert.*-leucine
 d) external reference sample

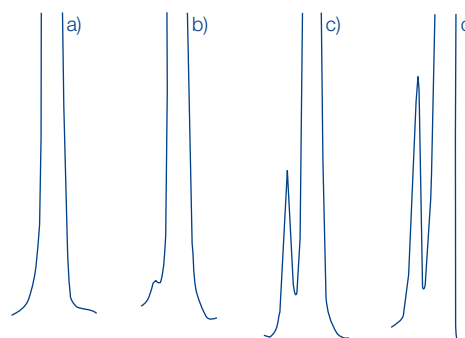

Ordering information

Plate size [cm]	5 x 20	10 x 10	10 x 20	20 x 20	Thickness of layer	Fluorescent indicator
Glass plates						
Pack of [plates]	4					
CHIRALPLATE			811056		0.25 mm	UV ₂₅₄
Pack of [plates]	50	25	25	25		
CHIRALPLATE	811057	811059	811055	811058	0.25 mm	UV ₂₅₄

SIL N-HR ^P unmodified standard silica layers

Technical characteristics

- High purity silica 60, mean pore size 60 Å, specific surface (BET) ~ 500 m²/g, specific pore volume 0.75 mL/g, particle size 5–17 µm, different binder system compared to SIL G results in different separation characteristics
- A special feature of the POLYGRAM® SIL N-HR is a higher gypsum content

Ordering information

Plate size [cm]	5 x 20	20 x 20	Thickness of layer	Fluorescent indicator
Pack of [plates]	50	25		
POLYGRAM® polyester sheets				
SIL N-HR/UV ₂₅₄	804022	804023	0.20 mm	UV ₂₅₄



SIL G-25 HR G special layer for aflatoxin separation

🔧 Technical characteristics

- High purity silica 60 with gypsum and a very small quantity of a polymeric organic binder; softer than the standard silica layer, i.e. spots can be scratched and the layer absorbs faster

✅ Recommended application

- Aflatoxins

Ordering information

Plate size [cm]	20 x 20	Thickness of layer	Fluorescent indicator
Pack of [plates]	25		

Glass plates

SIL G-25 HR	809033	0.25 mm	–
SIL G-25 HR/UV ₂₅₄	809043	0.25 mm	UV ₂₅₄

SIL G-25 Tenside G special layer for separation of surfactants

🔧 Technical characteristics

- Silica G impregnated with ammonium sulfate

✅ Recommended application

- Detergents, alkanesulfonates, polyglycols

Ordering information

Plate size [cm]	20 x 20	Thickness of layer	Fluorescent indicator
Pack of [plates]	25		

Glass plates

SIL G-25 Tenside	810063	0.25 mm	–
------------------	--------	---------	---

Nano-SIL PAH G special HPTLC silica layer for PAH analysis

🔧 Technical characteristics

- Nano silica 60, mean pore size 60 Å, specific surface (BET) ~ 500 m²/g, specific pore volume 0.75 mL/g, particle size 2–10 µm
- Impregnated with caffeine, an electron acceptor for PAH analysis based on charge-transfer complexes

✅ Recommended application

- 6 PAHs according to German drinking water specifications (TVO) in accordance with German standard DIN 38407 part 7

Ordering information

Plate size [cm]	10 x 20	Thickness of layer	Fluorescent indicator
Pack of [plates]	50		

Glass plates

Nano-SIL PAH	811051	0.20 mm	–
--------------	--------	---------	---

Further application examples can be found online in our application database at www.mn-net.com/apps



Layers for special TLC separations



IONEX ^P special mixed layers of silica with ion exchange resins

IONEX-25 SA-Na:

- Mixture of silica and a strongly acidic cation exchanger coated to polyester sheets

IONEX-25 SB-AC:

- Mixture of silica and a strongly basic anion exchanger coated to polyester sheets
- Both layers contain an inert organic binder

✓ Recommended application

- Amino acids, e.g., in protein and peptide hydrolyzates, in seeds and fodder, in biological fluids; for racemate separation in peptide syntheses, for the separation of nucleic acid hydrolyzates, aminosugars, amino acids, antibiotics, inorganic phosphates, cations and other compounds with ionic groups

Ordering information

Plate size [cm]	20 x 20	Thickness of layer	Fluorescent indicator
Pack of [plates]	25		

POLYGRAM[®] polyester sheets

IONEX-25 SA-Na	strongly acidic cation exchanger	806013	0.20 mm	–
IONEX-25 SB-AC	strongly basic anion exchanger	806023	0.20 mm	–

Mixed layers for TLC ^G

Alox/CEL-AC-Mix-25:

- Mixed layer of aluminum oxide G and acetylated cellulose, recommended for separation of PAH

SILCEL-Mix-25:

- Mixed layer of cellulose and silica, recommended for separation of preservatives and other antimicrobial compounds

Ordering information

Plate size [cm]	20 x 20	Thickness of layer	Fluorescent indicator
Pack of [plates]	25		

Glass plates

Alox/CEL-AC-Mix-25	810053	0.25 mm	–
SILCEL-Mix-25 UV ₂₅₄	810043	0.25 mm	UV ₂₅₄

Further application examples can be found online in our application database at www.mn-net.com/apps



Chromatography papers

Chromatography papers

- Paper chromatography is the oldest chromatographic technique separation due to partition of the analytes between special paper grades and the mobile phase, which penetrates the paper by capillary action ascending.
- Descending and circular techniques are possible

Please note

- Always treat chromatography papers with care
- Never touch them with fingers, because this will contaminate the surface
- Do not bend them sharply, because this will decrease the capillary action (preferably store them flat)

Direction

- Chromatography papers possess a preferred direction of the fibers with higher absorption properties (with our sheets 58 x 60 cm, the longer edge)
- We recommend to use them in the direction of higher absorption

Ordering information

Code	Weight [g/m ²]	Thickness [mm]	Description	Flow rate	Size [cm]	Pack of	REF
MN 214	140	0.28	smooth	90–100 mm/30 min	58 x 60	100 sheets	817001
MN 218	180	0.36	smooth	90–100 mm/30 min	58 x 60	100 sheets	817002
MN 260	90	0.20	smooth	120–130 mm/30 min	58 x 60	100 sheets	817003
MN 261	90	0.18	smooth	90–100 mm/30 min	58 x 60	100 sheets	817004
MN 827	270	0.70	soft carton	130–140 mm/10 min	58 x 60	100 sheets	817005
MN 866	650	1.70	soft carton	100–120 mm/10 min	38 x 38	100 sheets	817006
MN 866	650	1.70	soft carton	100–120 mm/10 min	80 x 80	100 sheets	817007
MN 214 ff	140	0.28	MN 214 defatted *	90–100 mm/30 min	56 x 58	100 sheets	817008

* This paper is extracted with organic solvents.

For further papers, filters and membranes, feel free to ask for our catalog "Filtration".





Accessories

• Beside ready-to-use layers for thin layer chromatography also accessories are required

• Selection of accessories for reliable separation in TLC

Ordering information

Designation	Pack of	REF
Simultaneous developing chamber for TLC, 20 x 20 cm	1	814019
Simultaneous developing chamber for TLC, 10 x 10 cm	1	814018
Developing chambers for TLC micro-sets	4	814021
Glass laboratory sprayer with rubber bulb	1	814101
Glass capillaries 1 µL	3 x 50	814022
Rubber caps for capillaries	2	814102
Plastic syringe, 1 mL content with graduation	1	814104
Spotting guides	2	814023
Measuring cylinders, glass, 10 mL content	2	814024
MN ALUGRAM® scissors, ground blade, black handle	1	818666
Filter paper MN 713, 15 x 21 cm	100	814103
Folded filters MN 615 1/4, 11 cm diameter	100	531011
Chromatography paper MN 260, 7.5 x 17 cm (for chamber saturation)	100	814030



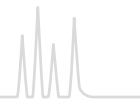

Visualization reagents

• Small selection of frequently used spray reagents for post chromatographic detection reactions in TLC suited for spraying or dipping TLC plates

• A detailed description of many more detection procedures for TLC is available on request

Ordering information

Spray reagent	Solvent	Detection of	Pack of	REF
Aniline phthalate	2-propanol – ethanol (1:1)	reducing sugars, oxohalic acids	100 mL	814919
Bromocresol green	2-propanol	organic acids	100 mL	814920
Reagent for caffeine detection	water – acetone	caffeine	100 mL	814401
2',7'-Dichlorofluorescein	2-propanol	lipids (saturated, unsaturated)	100 mL	814921
4-(Dimethylamino)-benzaldehyde	2-propanol	terpenes, sugars, steroids	100 mL	814922
Reagent according to Dragendorff-Munier	water	alkaloids and other nitrogen compounds	100 mL	814402
Iron(III) chloride	water	phenolic compounds e.g., acetylsalicylic acid, paracetamol	100 mL	814403
Potassium hexacyanoferrate(III)	water		100 mL	814404
Molybdato-phosphoric acid	ethanol	lipids, sterols, steroids, reducing compounds	100 mL	814302
Ninhydrin	ethanol	amino acids, amines and amino sugars	100 mL	814203
Rhodamine B	ethanol	lipids	100 mL	814923
Rubeanic acid	ethanol	heavy metal cations	100 mL	814206

These products contain harmful substances which must be specially labeled as hazardous. For detailed information please see SDS.



Fluorescent indicators

UV indicators with efficient radiation for short-wave as well as long-wave UV ranges

• UV₂₅₄: manganese-activated zinc silicate with absorption maximum at 254 nm, green fluorescence, relatively susceptible towards acids: its fluorescence can be completely quenched by acidic solvents

• UV₃₆₆: inorganic fluorescent pigment with absorption maximum at 366 nm, blue fluorescence

Ordering information

	Composition	Absorption maximum	Color of fluorescence	Pack of 100 g
Fluorescent indicator UV ₂₅₄	manganese-activated zinc silicate	254 nm	green	816710.01
Fluorescent indicator UV ₃₆₆	inorganic fluorescent pigment	366 nm	blue	816720.01



Silica adsorbent for TLC

Pore size 60 Å, pore volume 0.75 mL/g, specific surface (BET) ~ 500 m²/g, pH 7 for a 10 % aqueous suspension

- Silica G: standard grade, particle size 2–20 µm, Fe < 0.02 %, Cl < 0.02 %, 13 % gypsum as binder
- Silica N: standard grade, particle size 2–20 µm, Fe < 0.02 %, Cl < 0.02 %, no binder
- Silica G-HR: high purity grade, particle size 3–20 µm, Fe < 0.002 %, Cl < 0.008 %, gypsum as binder
- Silica P: preparative grade, particle size 5–50 µm, Fe < 0.02 %, Cl < 0.02 %, organic binder
- Silica P with gypsum: preparative grade, particle size 5–50 µm, Fe < 0.02 %, Cl < 0.02 %, gypsum as binder

Ordering information

Designation	Fluorescent indicator	1 kg	5 kg
Silica G	–	816310.1	816310.5
Silica G/UV ₂₅₄	UV ₂₅₄	816320.1	816320.5
Silica N	–	816330.1	816330.5
Silica N/UV ₂₅₄	UV ₂₅₄	816340.1	816340.5
Silica G-HR	–	816410.1	816410.5
Silica P/UV ₂₅₄	UV ₂₅₄	816380.1	816380.5
Silica P/UV ₂₅₄ with gypsums	UV ₂₅₄	816400.1	816400.5

Polyamid adsorbent for TLC

Polyamide 6 = nylon 6 = perlon = ε-polycaprolactame

Ordering information

Designation	Fluorescent indicator	1 kg
Polyamid-DC 6	–	816610.1
Polyamid-DC 6 UV ₂₅₄	UV ₂₅₄	816620.1

Cellulose MN 301 native fibrous cellulose

- Standard grade, fiber length (95 %) 2–20 µm
- Average degree of polymerization 400–500, specific surface acc. to Blaine 15 000 cm²/g
- ≤ 20 ppm Fe, 6 ppm Cu, 7 ppm P, CH₂Cl₂ extract ≤ 0.25 %, residue on ignition at 850 °C ≤ 1500 ppm

Ordering information

Designation	1 kg	5 kg
Cellulose MN 301	816250.1	816250.5

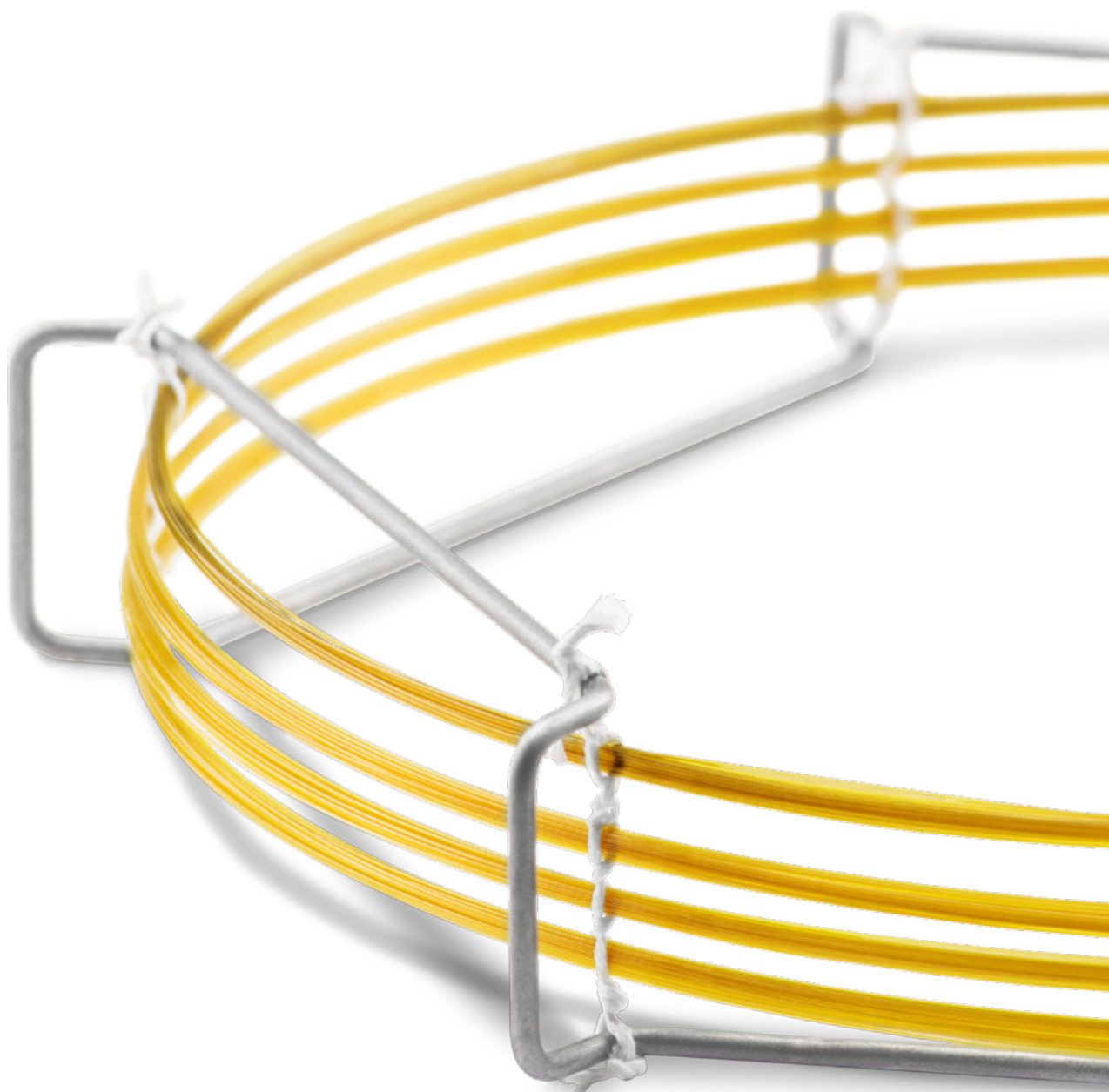



Contents

Basics.....	300
USP listing.....	302
Additional information for GC columns.....	303
Separation properties of OPTIMA® phases.....	305
Summary of MN phases for GC.....	306
OPTIMA® · nonpolar capillary columns.....	310
OPTIMA® · weakly polar capillary columns.....	314
OPTIMA® δ · phases with autoselectivity.....	318
OPTIMA® · medium polar capillary columns.....	321
OPTIMA® · polar capillary columns.....	328
PERMABOND® capillary columns.....	336
Special GC columns overview.....	339
Capillary columns for Fast GC.....	340
Capillary columns for enantiomer separation.....	342
Capillary columns for biodiesel analysis.....	346
Capillary columns for triglyceride analysis.....	348
Capillary columns for high temperature GC.....	349
Capillary columns for amine separation.....	350
Capillary columns for hydrocarbons.....	352
Capillary columns for silane · DEG.....	354
Fused silica capillaries.....	355
Reagents / methods for derivatization.....	357
Reagents / methods for acylation.....	359
Reagents / methods for alkylation / methylation.....	361
Reagents / methods for silylation.....	362
Derivatization procedures.....	367
Test mixtures for GC capillary columns.....	368
Ferrules for capillary columns.....	370
Septa for capillary column.....	371
Accessories for capillary columns.....	372
General accessories.....	373

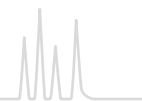

The GC system

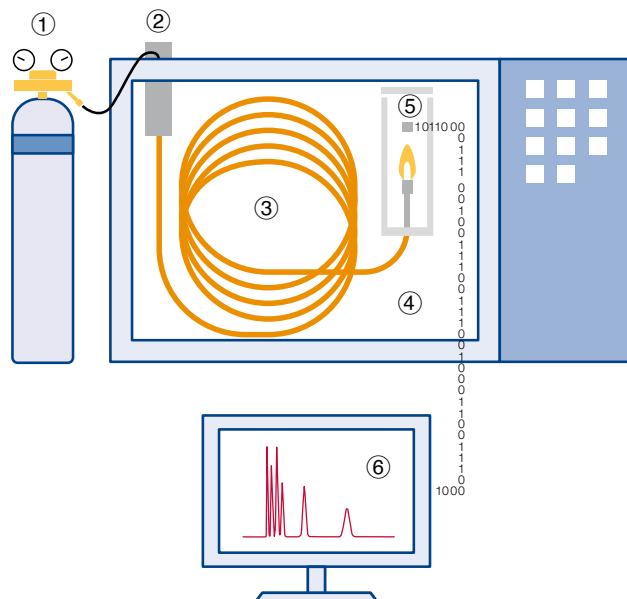

Configuration of a gas chromatograph

- ① Gas supply: carrier gas and - if necessary - detector gases e.g., for FID detector
- ② Sample injector: During direct injection, the sample is applied to the column without touching any other parts made from glass or metal (on-column injection). During indirect injection, the sample is brought into an evaporator and is then transferred onto the column either completely, or partially (split technique). Both techniques allow working at low temperatures, high temperatures and the use of temperature programming.
- ③ Capillary column: the heart of the GC system
- ④ Temperature-controlled oven
- ⑤ Detector: indicates a substance by generating an electrical signal (response). Some detectors are specific for certain classes of substances or for certain elements (e.g., P, N).
- ⑥ Data station for configuration of a gas chromatograph

The separation process

Chromatographic separation is achieved through continuous distribution of each sample component between the mobile and the stationary phase:

In GC, the mobile phase is always a gas, mostly either He, N₂ or H₂.

The stationary phase is often a viscous, gum-like liquid adhered to the inner wall of a capillary column (WCOT = Wall Coated Open Tubular).

Transport of the components occurs exclusively in the mobile phase, while separation only takes place in the stationary phase. The quality of a separation (resolution) depends on the residence time of the components within the stationary phase and on the rate of interactions. The type of interaction between component and phase (selectivity) is determined by the functional groups of the stationary phase. The polarity of the phase is a function of its substituents.

The chromatogram

A chromatogram consists of a base line and a number of peaks. The area of a peak allows quantitative determinations:

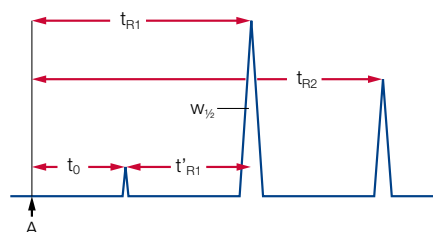

A: starting point of a chromatogram = time of injection of a dissolved solute

A component can be identified by its retention time (qualitative determination):

$$t_{Ri} = t_0 + t'_{Ri}$$

t_0 : dead time = residence time of a solute in the mobile phase (time required by a component to migrate through the chromatographic system without any interaction with the stationary phase)

t_{Ri} : retention time = time interval between peak i and the point of injection

t'_{Ri} : net retention time = difference between total retention time and dead time t_0 . It indicates how long a substance stays in the stationary phase.

Other terms characterizing a separation:

k'_i : retention factor: a measure for the position of a sample peak in the chromatogram. The retention factor is specific for a given compound and constant under constant conditions.

$$k'_i = \frac{t_{Ri} - t_0}{t_0}$$

α : relative retention, also called separation factor or selectivity coefficient, is the ratio of two capacity factors. The reference substance is always in the denominator.

$$\alpha = \frac{k'_2}{k'_1}$$

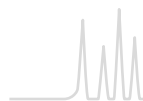

The relative retention does not provide any information on the quality of a separation. For equal values of α two very broad peaks may overlap (as shown in a), or may be completely resolved (as in b), if they are accordingly narrow.

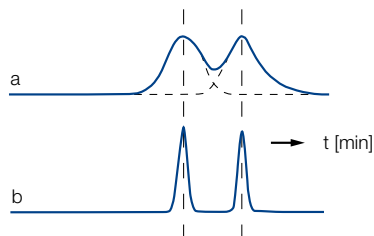

R: resolution: a measure for the quality of a separation, taking ($w_{1/2}$) into account according to:

$$R = 1.18 \cdot \frac{t_{R2} - t_{R1}}{(w_{1/2})_2 + (w_{1/2})_1}$$

N: number of theoretical plates: characterizes the quality of a column (should be determined for $k' > 5$). The height equivalent to a theoretical plate (h, HETP) is calculated by dividing the length L of the column by the number of theoretical plates Nth. The smaller this value the more efficient the column.

$$N = 5.54 \cdot \frac{(t_{R1})}{(w_{1/2})} \quad h = \text{HETP} = \frac{L}{N}$$

The Golay equation shows how the plate height h depends on the flow velocity u:

B: molecular axial diffusion; B is a function of the diffusion coefficient of the component in the respective carrier gas

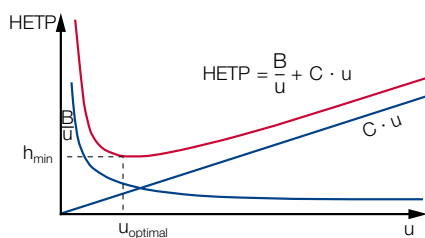

C: resistance to mass transfer

In practice often higher velocities than $u_{opt.}$ are chosen, if separation efficiency is sufficient. Higher carrier velocities mean shorter retention times.

Parameters characterizing a capillary column

OPTIMA® 5	1.0 µm film	30 m x	0.32 mm ID
A	B	C	D

A. Stationary phase

Different chemical structures of stationary phases are responsible for the type of interaction (selectivity) between the phase and the analytes. The stationary phase also limits the temperature range for chromatography. For a detailed summary of MN phases for GC please see the following chapter.

B. Film thickness

MACHEREY-NAGEL offers ranges from 0.1 to 5.0 µm. The standard film thickness is 0.25 µm. Thin films (0.1–0.2 µm) are very well suited for high-boiling, temperature-sensitive or almost contemporaneously eluting substances.

Increasing the film thickness will increase the capacity, the retention for low-boiling substances and the inertness of the column. This is especially helpful for samples with a broad range of concentrations, or the separation of volatile polar substances.

A better coverage of the column wall by a thicker film and a reduced column surface due to a shorter column have a positive impact on the separation of very active substrates, that may cause noticeable tailing when they come in contact with non-coated spots of the column wall.

Thick films, however, always mean more stationary phase in the column, hence increased column bleeding. Therefore, maximum operating temperatures for thick-film columns are reduced. In addition, thick-film columns may have a lesser separating capacity.

C. Column length

The separating efficiency (better the number of plates N) of a column is directly proportional to its length. Most routine separations are carried out on 25 or 30 m columns, while more complex samples may require 50 or 60 m. 10 m columns are common for Fast GC (see page 340).

D. Inner diameter (ID)

The lower the ID, the higher is the theoretically possible number of plates per meter.

0.1–0.2 mm ID:

for high resolution and short retention times at low carrier gas flow

0.25 mm ID:

for analysis of complex mixtures

0.32 mm ID:

for routine analysis with short retention times, but increased capacity

0.53 mm ID:

for rapid separations with inert surface and highest capacity

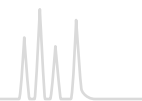

USP listing of MN GC phases			
Code	Specifications	MN GC phases	Page
USP G1 / G2	dimethylpolysiloxane oil	OPTIMA® 1	310
		OPTIMA® 1 MS	312
		OPTIMA® 1 MS Accent	312
		OPTIMA® 1-TG	348
		PERMABOND® SE-30	336
		PERMABOND® P-100	352
USP G3	50 % phenyl - 50 % methylpolysiloxane	OPTIMA® 17	327
		OPTIMA® 17 MS	328
		OPTIMA® 17-TG	348
USP G6	trifluoropropylmethylpolysiloxane	OPTIMA® 210	329
USP G7	50 % 3-cyanopropyl - 50 % phenylmethylpolysiloxane	OPTIMA® 225	330
USP G16	polyethylene glycol (average molecular weight ~ 15 000); high molecular weight compound of polyethylene glycol and diepoxide	OPTIMA® WAX	332
		OPTIMA WAXplus®	333
		PERMABOND® CW 20 M	337
		PERMABOND® CW 20 M-DEG	354
		FS-CW 20 M-AM	351
USP G19	25 % phenyl – 25 % cyanopropyl – 50 % methylsiloxane	OPTIMA® 225	330
USP G25	high molecular weight compound of polyethylene glycol and diepoxide, which is esterified with terephthalic acid	OPTIMA® FFAP	334
		OPTIMA® FFAPplus	335
		PERMABOND® FFAP	338
USP G27	5 % phenyl – 95 % methylpolysiloxane	OPTIMA® 5	314
		OPTIMA® 5 Amine	350
		OPTIMA® 5 HT	349
		OPTIMA® 5 MS	315
		OPTIMA® 5 MS Accent	316
		PERMABOND® SE-52	336
USP G28	25 % phenyl – 75 % methylpolysiloxane	OPTIMA® 35 MS	326
USP G32	20 % phenylmethyl – 80 % dimethylpolysiloxane	OPTIMA® 35 MS	326
USP G35	high molecular weight compound of polyethylene glycol and diepoxide, which is esterified with nitroterephthalic acid	OPTIMA® FFAP	334
		OPTIMA® FFAPplus	335
		PERMABOND® FFAP	338
USP G36	1 % vinyl – 5 % phenylmethylpolysiloxane	OPTIMA® 5	314
		OPTIMA® 5 Amine	350
		OPTIMA® 5 HT	349
		OPTIMA® 5 MS	315
		OPTIMA® 5 MS Accent	316
		PERMABOND® SE-54 HKW	352
USP G38	dimethylpolysiloxane oil	OPTIMA® 1	310
		OPTIMA® 1 MS	312
		OPTIMA® 1 MS Accent	312
		OPTIMA® 1-TG	348
		PERMABOND® SE-30	336
		PERMABOND® P-100	352
USP G42	35 % phenyl – 65 % dimethylpolysiloxane	OPTIMA® 35 MS	326
USP G43	6 % cyanopropylphenyl – 94 % dimethylpolysiloxane	OPTIMA® 1301	321
		OPTIMA® 1301 MS	322
		OPTIMA® 624	323
		OPTIMA® 624 LB	323
USP G46	14 % cyanopropylphenyl – 86 % methylpolysiloxane	OPTIMA® 1701	324
		OPTIMA® 1701 MS	325
USP G49	proprietary derivatized phenyl groups on a polysiloxane backbone	OPTIMA® 6-3	319



Scope of delivery

Each column is individually tested and supplied with test certificate and test chromatogram, but without fittings or ferrules. Columns have fused ends or are sealed with septa, to protect them from atmospheric oxygen. Further more an instruction leaflet is enclosed.

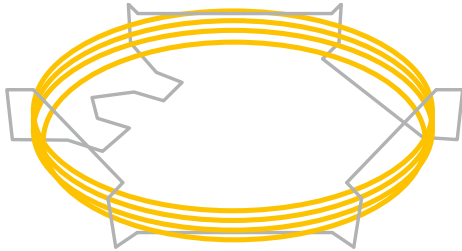

OPTIMA 5 MS

Column data:
 Ref: 726 600.30
 Length: 30 m
 ID: 0.25 mm
 Phase: 5% Phenylmethylsiloxane

Test conditions:
 Carrier gas: N₂
 Inlet temperature: 250 °C
 Oven temperature: 40 °C
 Detector temperature: 250 °C

Quality specifications - Test results:

Parameter	Value	Specification
Efficiency	1000000	> 1000000
Resolution	1.05	> 1.05
Peak shape	0.10	< 0.10

Check of quality specifications: GC 1000000

Notes: All columns are tested and certified according to the specifications of the respective standards.

MN
Macherey-Nagel

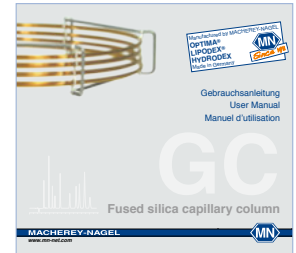

GC cages

The standard size of a GC cage is 7 inches. On request, all columns can be supplied on a 5 inch (13 cm) cage e.g., for the Agilent GC 6850. To order, please add an E at the end of the REF number (e.g., 726470.30E)

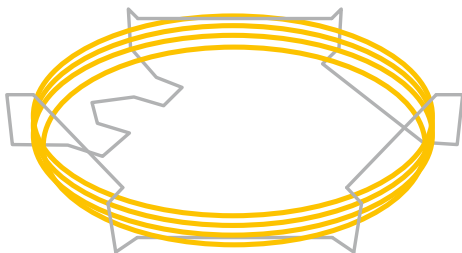

7 inches standard size e.g., REF 726600.30

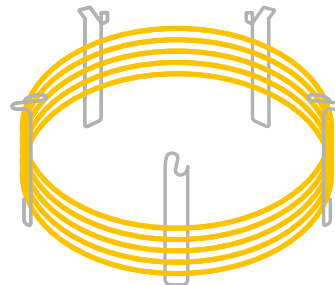

5 inches special cage e.g., REF 726600.30E

Integrated guard column

To prolong column life, even at highly contaminated or matrix-containing samples, MN offers the option to add an integrated guard column. All capillary columns are available with a 10 m guard column with respective deactivation. To order, please add V1 at the end of the REF number (e.g., 726600.30V1). Guard column combinations with other lengths, IDs or different deactivation are available on request.

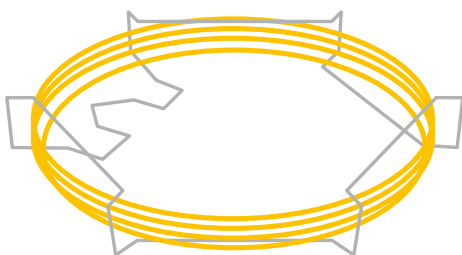

Without integrated guard column e.g., REF 726600.30

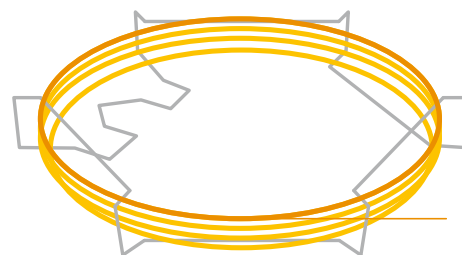

With integrated guard column e.g., REF 726600.30V1

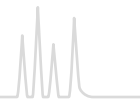

MACHEREY-NAGEL derivatization reagents

Purpose of derivatization

- Improved volatility, better thermal stability or a lower limit of detection in gas chromatography
- Prerequisite: quantitative, rapid and reproducible formation of only one derivative
- Halogen atoms inserted by derivatization (e.g., trifluoroacetates) for specific detection (ECD) with the advantage of high sensitivity
- Influence of elution orders and fragmentation patterns in MS by a specific derivatization
- We provide reagents for
 - Silylation
 - Alkylation (methylation)
 - Acylation
- For 1 x 10 mL, 1 x 50 mL and 6 x 50 mL also as screw neck vial
- Product range from page 357 onwards





Separation properties of OPTIMA® phases

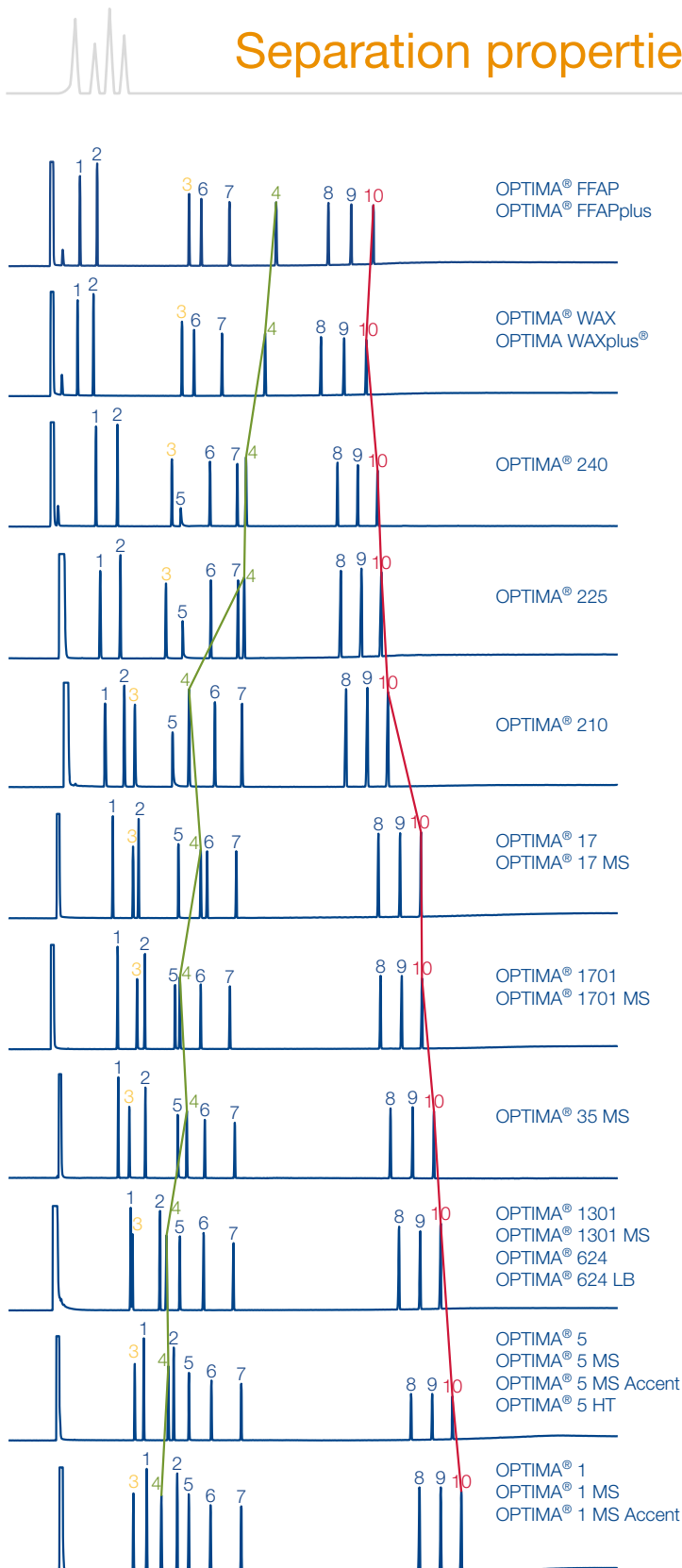

increasing polarity

Peaks:

- 1. Undecane
- 2. Dodecane
- 3. Octanol
- 4. Dimethylaniline
- 5. Decylamine
- 6. Methyl decanoate
- 7. Methyl undecanoate
- 8. Henicosaene
- 9. Docosane
- 10. Tricosane

All columns:

- Sample: 0.25 µm film, 30 m x 0.25 mm ID
- Injection: MN OPTIMA® test mixture (REF 722316)
- Carrier gas: 1.0 µL, split 15 mL/min
- Temperature: 0.80 bar He
- Detector: 80 °C T_{max} (isothermal), 8 °C/min (20 min T_{max})



Summary of MN phases for GC



Overview of OPTIMA® MN phases

Phase	Composition	Page	Relative polarity ^①	Maximum temperature ^②
OPTIMA® 1		310		
OPTIMA® 1 MS	100 % dimethylpolysiloxane	312		340 / 360 °C
OPTIMA® 1 MS Accent		312		
OPTIMA® 5	5 % phenyl – 95 % methylpolysiloxane	314		340 / 360 °C
OPTIMA® 5 MS	5 % diphenyl – 95 % dimethylpolysiloxane	315		340 / 360 °C
OPTIMA® 5 MS Accent	silarylene phase with selectivity similar to 5 % diphenyl – 95 % dimethylpolysiloxane	316		340 / 360 °C
OPTIMA® XLB	silarylene phase like above, optimized silarylene content for low bleeding	317		340 / 360 °C
OPTIMA® 5-3	phase with autoselectivity ^④	319		340 / 360 °C
OPTIMA® 5-6	phase with autoselectivity ^④	320		340 / 360 °C
OPTIMA® 1301	6 % cyanopropylphenyl – 94 % dimethylpolysiloxane	321		300 / 320 °C
OPTIMA® 1301 MS	silarylene phase with low bleeding: polarity similar to 6 % cyanopropylphenyl – 94 % dimethylpolysiloxane	322		300 / 320 °C
OPTIMA® 624	6 % cyanopropylphenyl – 94 % dimethylpolysiloxane	323		
OPTIMA® 624 LB	like above, phase with low bleeding	323		280 / 300 °C
OPTIMA® 1701	14 % cyanopropylphenyl – 86 % dimethylpolysiloxane	324		280 / 300 °C
OPTIMA® 1701 MS	silarylene phase with low bleeding: polarity similar to 14 % cyanopropylphenyl – 86 % dimethylpolysiloxane	325		280 / 300 °C

① = nonpolar, = polar

② First temperature (long term temperature) for isothermal operation, second value for the max. temperature (short term temperature) in a temperature program. Please note that for details refer to the description of individual phases.

③ Phases which provide a similar selectivity based on chemical and physical properties ④ See description on page 318

GC columns for special separations can be found from page 339 onwards.



Structure	USP	Similar phases ^③
$\left[\begin{array}{c} \text{CH}_3 \\ \\ \text{O}-\text{Si} \\ \\ \text{CH}_3 \end{array} \right]_n$	G1/G2/G38	PERMABOND® SE-30, OV-1, DB-1, SE-30, HP-1, SPB™-1, CP-Sil 5 CB, Rtx®-1, 007-1, BP1, MDN-1, AT™-1, ZB-1, OV-101 5% diphenyl – 95% dimethylpolysiloxane
$\left[\begin{array}{c} \text{CH}_3 \\ \\ \text{O}-\text{Si} \\ \\ \text{C}_6\text{H}_5 \end{array} \right]_m \left[\begin{array}{c} \text{CH}_3 \\ \\ \text{O}-\text{Si} \\ \\ \text{CH}_3 \end{array} \right]_n$	G27/G36	PERMABOND® SE-52, SE-54, SE-52, HP-5, SPB™-5, CP-Sil 8, Rtx®-5, 007-5, BP5, MDN-5, AT™-5, ZB-5
$\left[\begin{array}{c} \text{C}_6\text{H}_5 \\ \\ \text{O}-\text{Si} \\ \\ \text{C}_6\text{H}_5 \end{array} \right]_m \left[\begin{array}{c} \text{CH}_3 \\ \\ \text{O}-\text{Si} \\ \\ \text{CH}_3 \end{array} \right]_n$	G27/G36	DB-5, DB-5MS, HP-5MS, Ultra-2, Equity™-5, CP-Sil 8CB low bleed/MS, Rxi®-5MS, Rtx®-5SIL-MS, Rtx®-5MS, 007-5MS, BPX™5, MDN-5S, AT™-5MS, VF-5MS
$\left[\begin{array}{cc} \text{CH}_3 & \text{CH}_3 \\ & \\ \text{Si} & -\text{C}_6\text{H}_4- \\ & \\ \text{CH}_3 & \text{CH}_3 \end{array} \right]_n \left[\begin{array}{c} \text{CH}_3 \\ \\ \text{Si}-\text{O} \\ \\ \text{CH}_3 \end{array} \right]_o$	G27/G36	
$\left[\begin{array}{cc} \text{CH}_3 & \text{CH}_3 \\ & \\ \text{Si} & -\text{C}_6\text{H}_4- \\ & \\ \text{CH}_3 & \text{CH}_3 \end{array} \right]_n \left[\begin{array}{c} \text{CH}_3 \\ \\ \text{Si}-\text{O} \\ \\ \text{CH}_3 \end{array} \right]_o$	-	DB-XLB, Rxi®-XLB, Rtx®-XLB, MDN-12, VF-XMS
see description page 318	G49	no similar phases
see description page 318	-	no similar phases
$\left[\begin{array}{c} \text{C}_6\text{H}_5 \\ \\ \text{O}-\text{Si} \\ \\ \text{NC}-(\text{CH}_2)_3 \end{array} \right]_m \left[\begin{array}{c} \text{CH}_3 \\ \\ \text{O}-\text{Si} \\ \\ \text{CH}_3 \end{array} \right]_n$	G43	HP-1301, DB-1301, SPB™-1301, Rtx®-1301, CP-1301, 007-1301
$\left[\begin{array}{c} \text{NC}-(\text{CH}_2)_3 \\ \\ \text{Si}-\text{O} \\ \\ \text{NC}-(\text{CH}_2)_3 \end{array} \right]_m \left[\begin{array}{cc} \text{CH}_3 & \text{CH}_3 \\ & \\ \text{Si} & -\text{C}_6\text{H}_4- \\ & \\ \text{CH}_3 & \text{CH}_3 \end{array} \right]_{2m} \left[\begin{array}{c} \text{CH}_3 \\ \\ \text{Si}-\text{O} \\ \\ \text{CH}_3 \end{array} \right]_n$	G43	VF-1301ms, Rxi®-1301Sil MS, TG-1301MS
$\left[\begin{array}{c} \text{C}_6\text{H}_5 \\ \\ \text{O}-\text{Si} \\ \\ \text{NC}-(\text{CH}_2)_3 \end{array} \right]_m \left[\begin{array}{c} \text{CH}_3 \\ \\ \text{O}-\text{Si} \\ \\ \text{CH}_3 \end{array} \right]_n$	G43	HP-624, HP-VOC, DB-624, DB-VRX, SPB™-624, CP-624, Rtx®-624, Rtx®-Volatiles, 007-624, BP624, VOCOL
$\left[\begin{array}{c} \text{C}_6\text{H}_5 \\ \\ \text{O}-\text{Si} \\ \\ \text{NC}-(\text{CH}_2)_3 \end{array} \right]_m \left[\begin{array}{c} \text{CH}_3 \\ \\ \text{O}-\text{Si} \\ \\ \text{CH}_3 \end{array} \right]_n$	G46	OV-1701, DB-1701, CP-Sil 19 CB, HP-1701, Rtx®-1701, SPB™-1701, 007-1701, BP10, ZB-1701
$\left[\begin{array}{c} \text{NC}-(\text{CH}_2)_3 \\ \\ \text{Si}-\text{O} \\ \\ \text{NC}-(\text{CH}_2)_3 \end{array} \right]_m \left[\begin{array}{cc} \text{CH}_3 & \text{CH}_3 \\ & \\ \text{Si} & -\text{C}_6\text{H}_4- \\ & \\ \text{CH}_3 & \text{CH}_3 \end{array} \right]_{2m} \left[\begin{array}{c} \text{CH}_3 \\ \\ \text{Si}-\text{O} \\ \\ \text{CH}_3 \end{array} \right]_n$	G46	VF-1701ms, TG-1701MS, OV-1701, DB-1701, HP-1701, Rtx®-1701, SPB™-1701, CP Sil 19 CB, 007-1701, BP10, ZB-1701

that for columns with 0.53 mm ID and for columns with thicker films temperature limits are generally lower.



Summary of MN phases for GC

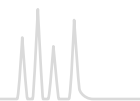

Phase	Composition	Page	Relative polarity ^①	Maximum temperature ^②
OPTIMA® 35 MS	silarylene phase with selectivity similar to 35 % diphenyl – 65 % dimethylpolysiloxane	326		360 / 370 °C
OPTIMA® 17	phenylmethylpolysiloxane, 50 % phenyl	327		320 / 340 °C
OPTIMA® 17 MS	silarylene phase with selectivity similar to 50 % phenyl – 50 % methylpolysiloxane	328		340 / 360 °C
OPTIMA® 210	trifluoropropylmethylpolysiloxane (50 % trifluoropropyl)	329		260 / 280 °C
OPTIMA® 225	50 % cyanopropylmethyl – 50 % phenylmethylpolysiloxane	330		260 / 280 °C
OPTIMA® 240	33 % cyanopropylmethyl – 67 % dimethylpolysiloxane	331		260 / 280 °C
OPTIMA® WAX	polyethylene glycol 20 000 Da	332		240 / 250 °C
OPTIMA WAXplus®	polyethylene glycol with optimized cross-linking	333		260 / 270 °C
OPTIMA® FFAP	polyethylene glycol 2-nitroterephthalate	334		250 / 260 °C
OPTIMA® FFAPplus	polyethylene glycol 2-nitroterephthalate with optimized cross-linking	335		250 / 260 °C

① = nonpolar, = polar

② First temperature (long term temperature) for isothermal operation, second value for the max. temperature (short term temperature) in a temperature program. Please note that for details refer to the description of individual phases.

③ Phases which provide a similar selectivity based on chemical and physical properties

GC columns for special separations can be found from page 339 onwards.

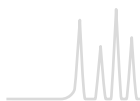

Summary of MN phases for GC



Structure	USP	Similar phases [®]
$\left[\begin{array}{c} \text{C}_6\text{H}_5 \\ \\ \text{Si}-\text{O} \\ \\ \text{C}_6\text{H}_5 \end{array} \right]_m \left[\begin{array}{c} \text{CH}_3 \\ \\ \text{Si}-\text{C}_6\text{H}_4-\text{Si} \\ \quad \\ \text{CH}_3 \quad \text{CH}_3 \end{array} \right]_n \left[\begin{array}{c} \text{CH}_3 \\ \\ \text{Si}-\text{O} \\ \\ \text{CH}_3 \end{array} \right]_o$	G28 / G32 / G42	DB-35 MS, HP-35, SPB [™] -35, Rxi [®] -35SIL MS, Rtx-35, 007-35, BPX [™] -35, MDN-35, AT [™] -35 MS, ZB-35, OV-11, VF-35 MS
$\left[\begin{array}{c} \text{CH}_3 \\ \\ \text{O}-\text{Si} \\ \\ \text{C}_6\text{H}_5 \end{array} \right]_m$	G3	OV-17, DB-17, HP-50+, HP-17, SPB [™] -50, SP-2250, Rxi [®] -17, Rtx [®] -50, CP-Sil 24 CB, 007-17, ZB-50
$\left[\begin{array}{c} \text{CH}_3 \\ \\ \text{O}-\text{Si}-\text{C}_6\text{H}_4-\text{C}_6\text{H}_4-\text{Si} \\ \quad \\ \text{CH}_3 \quad \text{CH}_3 \end{array} \right]_m \left[\begin{array}{c} \text{C}_6\text{H}_5 \\ \\ \text{O}-\text{Si} \\ \\ \text{C}_6\text{H}_5 \end{array} \right]_n$	G3	OV-17, AT [™] -50, BPX [™] -50, DB-17, DB-17ms, HP-50+, HP-17, SPB [™] -50, SPB [™] -17, SP-2250, Rtx [®] -50, CP-Sil 24 CB, 007-17, VF-17ms, ZB-50
$\left[\begin{array}{c} \text{CH}_3 \\ \\ \text{O}-\text{Si} \\ \\ \text{F}_3\text{C}-(\text{CH}_2)_2 \end{array} \right]_n$	G6	OV-210, DB-210, Rtx [®] -200, 007-210
$\left[\begin{array}{c} \text{CH}_3 \\ \\ \text{O}-\text{Si} \\ \\ \text{NC}-(\text{CH}_2)_3 \end{array} \right]_m \left[\begin{array}{c} \text{CH}_3 \\ \\ \text{O}-\text{Si} \\ \\ \text{C}_6\text{H}_5 \end{array} \right]_n$ <p style="text-align: center;">$m = n$</p>	G7 / G19	DB-225, HP-225, OV-225, Rtx [®] -225, CP-Sil 43, 007-225, BP225
$\left[\begin{array}{c} \text{CH}_3 \\ \\ \text{O}-\text{Si} \\ \\ \text{NC}-(\text{CH}_2)_3 \end{array} \right]_m \left[\begin{array}{c} \text{CH}_3 \\ \\ \text{O}-\text{Si} \\ \\ \text{CH}_3 \end{array} \right]_n$	-	no similar phases
$\text{H} \left[\begin{array}{c} \text{H} \quad \text{H} \\ \quad \\ \text{O}-\text{C}-\text{C}-\text{OH} \\ \quad \\ \text{H} \quad \text{H} \end{array} \right]_n$	G16	PERMABOND [®] CW 20 M, DB-Wax, Supelcowax, HP-Wax, HP-INNOWAX, Rtx-Wax, CP-Wax 52 CB, Stabilwax, 007-CW, BP20, AT-Wax, ZB-Wax DB-Wax, Supelcowax, HP-Wax, HP-INNOWAX, Rtx-Wax, CP-Wax 52 CB, Stabilwax, 007-CW, BP20, AT-Wax, ZB-Wax
$\left[\begin{array}{c} \text{O} \\ \\ \text{C}-\text{C}_6\text{H}_3(\text{NO}_2)-\text{C} \\ \\ \text{O} \end{array} \right]_n \text{-(OCH}_2\text{CH}_2\text{)}_m \text{-O}$	G35 / G25	PERMABOND [®] FFAP, DB-FFAP, HP-FFAP, CP-Wax 58 FFAP CB, 007-FFAP, CP-FFAP CB, NukoI [™] , AT-1000, SPB-1000, BP21, OV-351 DB-FFAP, HP-FFAP, CP-SIL 58 CB, 007-FFAP, CP-FFAP CB, NukoI [™]

hat for columns with 0.53 mm ID and for columns with thicker films temperature limits are generally lower.



OPTIMA[®] · nonpolar capillary columns

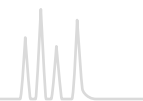

OPTIMA[®] 1 100 % dimethylpolysiloxane · USP G1 / G2 / G38

★ Key features

- Nonpolar phase
- Structure see page 307

✓ Recommended application

- Separation of components according to boiling points
- Thick film columns $\geq 3 \mu\text{m}$ film are especially recommended for solvent analysis.

✍ Temperature

- Columns with 0.1–0.32 mm ID and films $< 3 \mu\text{m}$:
 T_{max} 340 °C (long-term temperature),
 T_{max} 360 °C (short-term max. temperature in a temperature program)
- 0.53 mm ID, films $< 3 \mu\text{m}$:
 T_{max} 320 and 340 °C, resp.
- Thick film columns with films $\geq 3 \mu\text{m}$:
max. temperatures 300 and 320 °C, resp.

Similar phases

- PERMABOND[®] SE-30 (see page 336), OV-1, DB-1, SE-30, HP-1, SPB[™]-1, CP-Sil 5 CB, Rtx[®]-1, 007-1, BP1, MDN-1, AT[™]-1, ZB-1, OV-101

Ordering information

OPTIMA[®] 1

	Length → 10 m	12 m	15 m	20 m	25 m	30 m	50 m	60 m
0.1 mm ID (0.4 mm OD)								
0.10 μm film	726024.10			726024.20				
0.40 μm film				726025.20				
0.2 mm ID (0.4 mm OD)								
0.10 μm film					726832.25			
0.20 μm film	726834.12				726834.25		726834.50	
0.35 μm film	726837.12				726837.25		726837.50	
0.50 μm film							726839.50	
0.25 mm ID (0.4 mm OD)								
0.10 μm film	726038.10		726038.15		726038.25	726038.30		726038.60
0.25 μm film	726050.10		726050.15		726050.25	726050.30	726050.50	726050.60
0.50 μm film	726081.10				726081.25	726081.30	726081.50	726081.60
1.00 μm film					726802.25	726802.30	726802.50	726802.60
0.32 mm ID (0.5 mm OD)								
0.10 μm film	726301.10				726301.25	726301.30	726301.50	726301.60
0.25 μm film	726302.10		726302.15		726302.25	726302.30	726302.50	726302.60
0.35 μm film					726821.25	726821.30	726821.50	726821.60
0.50 μm film	726304.10				726304.25	726304.30	726304.50	726304.60
1.00 μm film	726323.10		726323.15		726323.25	726323.30	726323.50	726323.60
3.00 μm film					726805.25	726805.30	726805.50	726805.60
5.00 μm film	726931.10				726931.25	726931.30	726931.50	
0.53 mm ID (0.8 mm OD)								
0.50 μm film			726519.15		726519.25	726519.30		
1.00 μm film	726529.10		726529.15		726529.25	726529.30		
2.00 μm film	726521.10				726521.25	726521.30	726521.50	
5.00 μm film	726926.10				726926.25	726926.30	726926.50	

In addition to this standard program we will be happy to supply columns custom-made to your specifications. Information about scope of delivery, special cages and integrated guard columns see additional information for GC columns on page 303.



OPTIMA[®] · nonpolar capillary columns



Solvent analysis

MN Appl. No. 201390

Column: OPTIMA[®] 1, 60 m x 0.32 mm ID, 1.0 µm film
Sample: solvent mixture, courtesy of J. Lutz, Alcan Rorschach, Switzerland
Injection: 0.4 µL, split 1:60
Carrier gas: H₂, 120 kPa
Temperature: 50 °C (9 min) → 90 °C, 4 °C/min → 280 °C (2 min), 14 °C/min
Detector: FID 300 °C

Peaks:

- | | |
|------------------------------------|----------------------------|
| 1. Methanol | 26. Heptanol |
| 2. Ethanol | 27. Ethyl diglycol |
| 3. Acetone | 28. Butyl diglycol |
| 4. 2-Propanol | 29. Butyl glycol acetate |
| 5. Methyl acetate | 30. Butyl diglycol acetate |
| 6. <i>n</i> -Propanol | |
| 7. Methyl ethyl ketone | |
| 8. Ethyl acetate | |
| 9. Isobutanol | |
| 10. <i>n</i> -Butanol | |
| 11. 1-Methoxy-2-propanol | |
| 12. Isooctane | |
| 13. Ethyl glycol | |
| 14. Isoheptane | |
| 15. Methyl isobutyl ketone | |
| 16. 1-Ethoxy-2-propanol | |
| 17. Toluene | |
| 18. Isobutyl acetate | |
| 19. Butyl acetate | |
| 20. 4-Hydroxy-4-methyl-2-pentanone | |
| 21. 1-Methoxy-2-propyl acetate | |
| 22. Xylene | |
| 23. Cyclohexanone | |
| 24. Ethyl glycol acetate | |
| 25. Butyl glycol | |

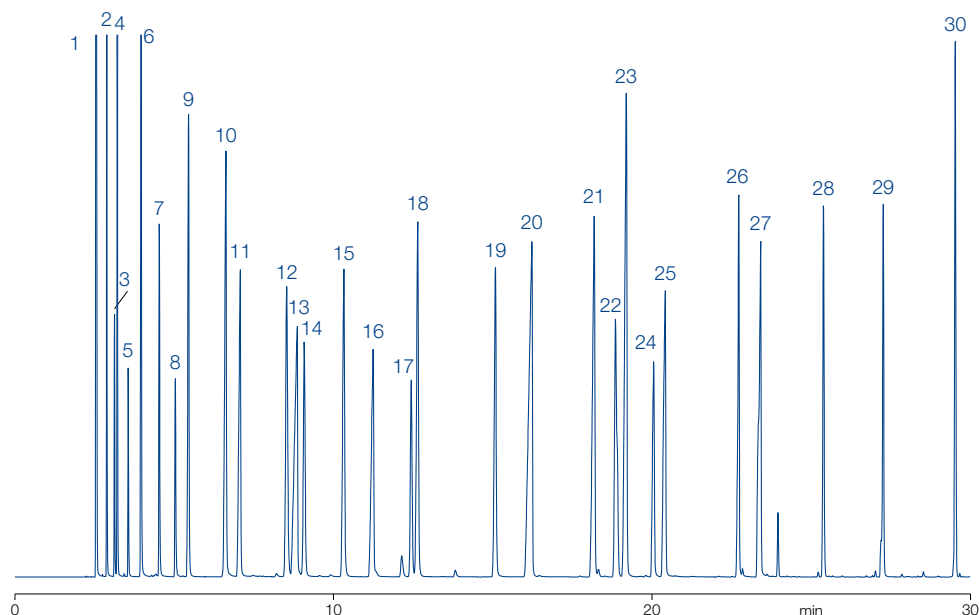



OPTIMA® · nonpolar capillary columns



OPTIMA® 1 MS 100 % dimethylpolysiloxane · USP G1 / G2 / G38

★ Key features

- Selectivity identical to OPTIMA® 1, Phase with low bleeding
- Structure see page 307

✓ Recommended application

- GC/MS and ECD, general analysis at trace level

✍ Temperature

- T_{max} 340 °C (long-term temperature), T_{max} 360 °C (short-term max. temperature in a temperature program)

Similar phases

- Ultra-1, DB-1MS, HP-1MS, Rxi®-1MS, Rtx®-1MS, Equity™-1, AT™-1MS, VF-1MS, CP-Sil 5 CB MS

Ordering information

OPTIMA® 1 MS

	Length →					
	12 m	15 m	25 m	30 m	50 m	60 m
0.2 mm ID (0.4 mm OD)						
0.20 µm film			726201.25		726201.50	
0.35 µm film	726203.12					
0.25 mm ID (0.4 mm OD)						
0.25 µm film		726205.15		726205.30		726205.60
0.32 mm ID (0.5 mm OD)						
0.25 µm film				726202.30		726202.60

In addition to this standard program we will be happy to supply columns custom-made to your specifications. Information about scope of delivery, special cages and integrated guard columns see additional information for GC columns on page 303.

OPTIMA® 1 MS Accent 100 % dimethylpolysiloxane · USP G1 / G2 / G38

★ Key features

- Selectivity identical to OPTIMA® 1, nonpolar phase
- Lowest column bleed
- Solvent rinsing for removal of impurities applicable
- Increased sensitivity due to an unmatched low background level
- Structure see page 307

✓ Recommended application

- Ideal for ion trap and quadrupole MS detectors
- Perfect inertness for basic compounds
- All-round phase for environmental analysis, trace analysis, EPA methods, pesticides, PCB, food and drug analysis

✍ Temperature

- T_{max} 340 °C (long-term temperature), T_{max} 360 °C (short-term max. temperature in a temperature program)

Similar phases

- Ultra-1, DB-1MS, HP-1MS, Rxi®-1MS, Rtx®-1MS, Equity™-1, AT™-1MS, VF-1MS, CP-Sil 5 CB MS



EPA 8140/8141/8141 A Organophosphorus pesticides

MN Appl. No. 213030

Column: OPTIMA® 1 MS Accent, 30 m x 0.32 mm ID, 0.50 µm film
 Sample: 0.2 µg/mL in hexane,
 8140/8141 OP pesticides calibration mix A
 and 8141 OP pesticides calibration mix B;
 IS triphenyl phosphate and tributyl phosphate
 Injection: 250 °C, splitless (hold 1 min)
 Carrier gas: He, 1 mL/min, constant pressure
 Temperature: 100 °C → 180 °C, 10 °C/min (2 min) → 300 °C, 18 °C/min (3 min)
 Detector: FPD (Flame Photometric Detector), 280 °C

Peaks:

1. Dichlorvos	19. Fonophos	38. Stirofos
2. Hexamethylphospho- ramide	20. Phosphamidon isomer	39. Tokuthion
3. Mevinphos	21. Diazinon	40. Merphos oxidation product
4. Trichlorfon	22. Disulfoton	41. Fensulfothion
5. TEPP	23. Phosphamidon	42. Famphur
6. Thionazin	24. Dichlorofenthion	43. Ethion
7. Demeton-O	25. Parathion-methyl	44. Bolstar
8. Ethoprop	26. Chlorpyrifos-methyl	45. Carbophenothion
9. Tributyl phosphate (IS)	27. Ronnel	46. Triphenyl phosphate (IS)
10. Dicrotophos	28. Fenitrothion	47. Phosmet
11. Monocrotophos	29. Malathion	48. EPN
12. Naled	30. Fenthion	49. Azinphos-methyl
13. Sulfotepp	31. Aspon	50. Leptophos
14. Phorate	32. Parathion-ethyl	51. Tri-o-cresyl phosphate
15. Dimethoate	33. Chlorpyrifos	52. Azinphos-ethyl
16. Demeton-S	34. Trichloronate	53. Coumaphos
17. Dioxathion	35. Chlorfenvinphos	
18. Terbufos	36. Merphos	
	37. Crotoxyphos	

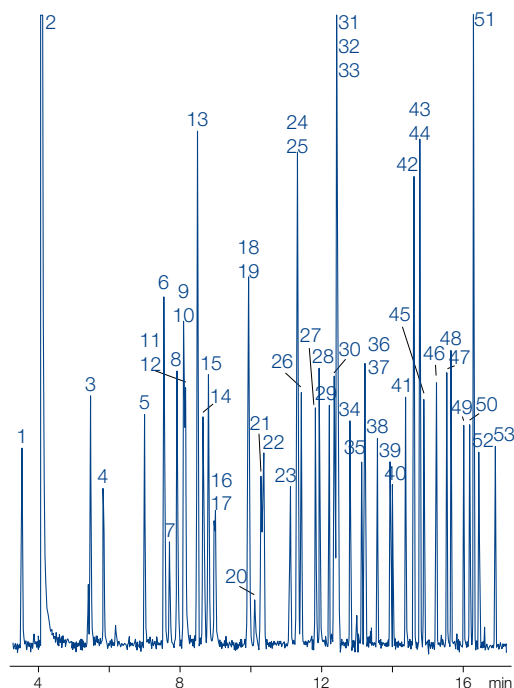

Ordering information

OPTIMA® 1 MS Accent

	Length →				
	15 m	25 m	30 m	50 m	60 m
0.2 mm ID (0.4 mm OD)					
0.20 µm film		725801.25		725801.50	
0.25 mm ID (0.4 mm OD)					
0.25 µm film	725805.15		725805.30		725805.60
0.50 µm film			725806.30		725806.60
0.32 mm ID (0.5 mm OD)					
0.25 µm film			725802.30		725802.60
0.50 µm film			725807.30		725807.60

In addition to this standard program we will be happy to supply columns custom-made to your specifications. Information about scope of delivery, special cages and integrated guard columns see additional information for GC columns on page 303.



OPTIMA® · weakly polar capillary columns

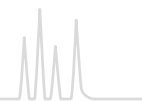

OPTIMA® 5 5 % phenyl – 95 % methylpolysiloxane · USP G27 / G36

★ Key features

- Nonpolar phase
- Structure see page 307

✓ Recommended application

- Standard phase with large range of application

✍ Temperature

- Columns with 0.1–0.32 mm ID and films < 3 µm:
T_{max} 340 °C (long-term temperature),
T_{max} 360 °C (short-term max. temperature in a temperature program)
- 0.53 mm ID, films < 3 µm:
T_{max} 320 and 340 °C, resp.
- Thick film columns with films ≥ 3 µm:
max. temperatures 300 and 320 °C, resp.

Similar phases

- PERMABOND® SE-52 (see page 336), SE-54, SE-52, HP-5, SPB™-5, CP-Sil 8, Rtx®-5, 007-5, BP5, MDN-5, AT™-5, ZB-5

Ordering information

OPTIMA® 5

	Length →					
	10 m	15 m	25 m	30 m	50 m	60 m
0.1 mm ID (0.4 mm OD)						
0.10 µm film	726846.10					
0.2 mm ID (0.4 mm OD)						
0.10 µm film			726854.25			
0.20 µm film			726857.25		726857.50	
0.35 µm film			726860.25		726860.50	
0.50 µm film			726863.25		726863.50	
0.25 mm ID (0.4 mm OD)						
0.10 µm film			726911.25	726911.30	726911.50	726911.60
0.25 µm film	726056.10	726056.15	726056.25	726056.30	726056.50	726056.60
0.35 µm film			726623.25	726623.30	726623.50	726623.60
0.50 µm film			726099.25	726099.30	726099.50	726099.60
1.00 µm film			726807.25	726807.30	726807.50	726807.60
0.32 mm ID (0.5 mm OD)						
0.10 µm film	726313.10	726313.15	726313.25	726313.30	726313.50	726313.60
0.25 µm film		726314.15	726314.25	726314.30	726314.50	726314.60
0.35 µm film			726628.25	726628.30	726628.50	726628.60
0.50 µm film			726316.25	726316.30	726316.50	726316.60
1.00 µm film		726325.15	726325.25	726325.30	726325.50	726325.60
3.00 µm film			726809.25	726809.30	726809.50	726809.60
5.00 µm film		726934.15	726934.25	726934.30	726934.50	
0.53 mm ID (0.8 mm OD)						
0.50 µm film	726523.10		726523.25	726523.30		
1.00 µm film	726541.10	726541.15	726541.25	726541.30		
2.00 µm film	726525.10		726525.25	726525.30	726525.50	726525.60
5.00 µm film	726916.10		726916.25	726916.30	726916.50	

In addition to this standard program we will be happy to supply columns custom-made to your specifications. Information about scope of delivery, special cages and integrated guard columns see additional information for GC columns on page 303.

Further applications can be found online in our application database at www.mn-net.com/apps

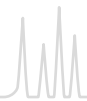

OPTIMA® · weakly polar capillary columns



OPTIMA® 5 MS 5 % diphenyl – 95 % dimethylpolysiloxane · USP G27 / G36

★ Key features

- Selectivity identical to OPTIMA® 5
- Phase with low bleeding
- Structure see page 307

✓ Recommended application

- GC/MS and ECD, applications and general analysis at trace level
- Perfect inertness for basic compounds

✍ Temperature

- T_{max} 340 °C (long-term temperature), T_{max} 360 °C (short-term max. temperature in a temperature program)

Similar phases

- DB-5, DB-5MS, HP-5MS, Ultra-2, Equity™-5, CP-Sil 8CB low bleed/MS, Rxi®-5MS, Rtx®-5SIL-MS, Rtx®-5MS, 007-5MS, BPX™5, MDN-5S, AT™-5MS, VF-5MS

Analysis of various phenols

MN Appl. No. 210110

Column: OPTIMA® 5 MS, 30 m x 0.25 mm ID, 0.25 µm film
 Sample: 5 ppm of each compound except *N*-*i*-propylaniline (9.4 ppm)
 Method: SPME
 Temperature: 40 °C (2 min) → 240 °C, 6 °C/min → 320 °C, 20 °C/min
 Detector: MSD

Peaks:

1. Toluene-D₈
2. Phenol
3. 2-Methylphenol (o-Cresol)
4. Nitrobenzene-D₅
5. *N*-*i*-Propylaniline
6. 2,4-Dichlorophenol
7. 4-Chlorophenol
8. 4-Bromo-2-chlorophenol
9. 3-Bromophenol
10. 4-Chloro-3-methylphenol
11. 2,4-Dibromophenol
12. 2-Hydroxybiphenyl
13. 2-Cyclohexylphenol
14. Hexafluorobisphenol A

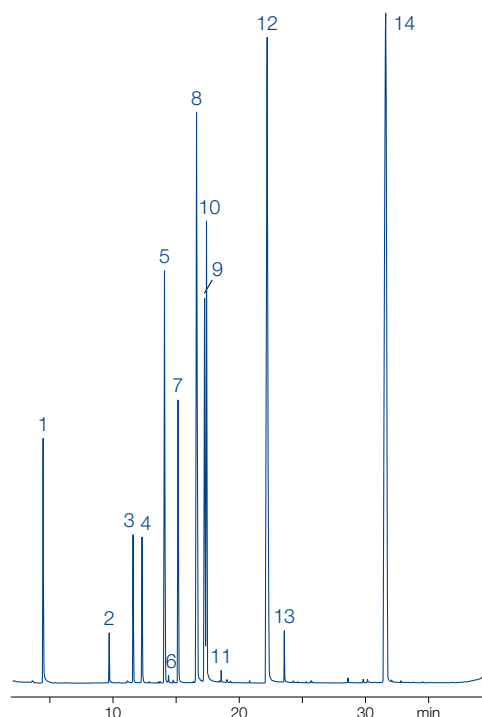

Courtesy of Riedel-de-Haën, Seelze, Germany

Ordering information

OPTIMA® 5 MS

	Length →					
	12 m	15 m	25 m	30 m	50 m	60 m
0.2 mm ID (0.4 mm OD)						
0.20 µm film	726210.12		726210.25		726210.50	
0.35 µm film	726215.12		726215.25		726215.50	
0.25 mm ID (0.4 mm OD)						
0.25 µm film		726220.15		726220.30		726220.60
0.50 µm film				726225.30		726225.60
1.00 µm film				726226.30		726226.60
0.32 mm ID (0.5 mm OD)						
0.25 µm film				726211.30		
0.50 µm film				726213.30		
1.00 µm film			726212.25		726212.50	726212.60

In addition to this standard program we will be happy to supply columns custom-made to your specifications. Information about scope of delivery, special cages and integrated guard columns see additional information for GC columns on page 303.

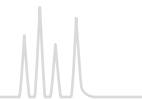

OPTIMA® 5 MS Accent silarylene phase · USP G27 / G36

★ Key features

- Chemically bonded, cross-linked silarylene phase with polarity similar to a 5 % diphenyl - 95 % dimethylpolysiloxane phase
- Lowest column bleed, nonpolar phase, solvent rinsing for removal of impurities applicable
- Structure see page 307

✓ Recommended application

- Ideal for ion trap and quadrupole MS detectors
- Perfect inertness for basic compounds
- All-round phase for environmental analysis, trace analysis, EPA methods, pesticides, PCB, food and drug analysis

✍ Temperature

- T_{max} 340 °C (long-term temperature), T_{max} 360 °C (short-term max. temperature in a temperature program)
- Film thickness > 0.5 µm:
 T_{max} 320 and 340 °C, resp.

Similar phases

- DB-5, DB-5MS, HP-5MS, Ultra-2, Equity™-5, CP-Sil 8CB low bleed/MS, Rxi®-5MS, Rtx®-5SIL-MS, Rtx®-5MS, 007-5MS, BPX™5, MDN-5S, AT™-5MS, VF-5MS

Increased sensitivity due to an unmatched low background level

The bleed comparison test of OPTIMA® 5 MS Accent with a conventional 5 MS phase shows the outstanding performance of the silarylene phase.

The unmatched low background level of the OPTIMA® 5 MS Accent, which is approximately three times lower compared to a 5 MS brand column, provides significantly increased sensitivity and allows its application in trace analysis particularly of high-boiling compounds.

Background noise at 340 °C

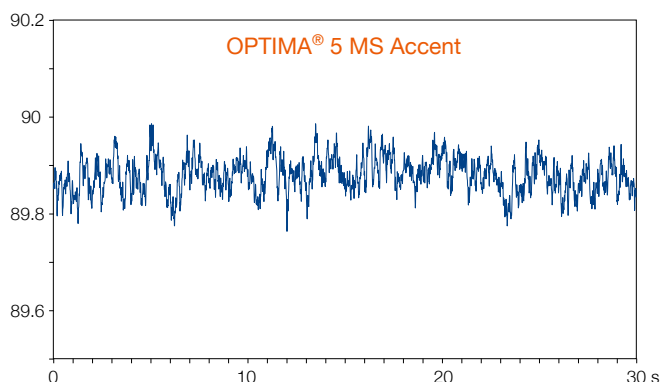
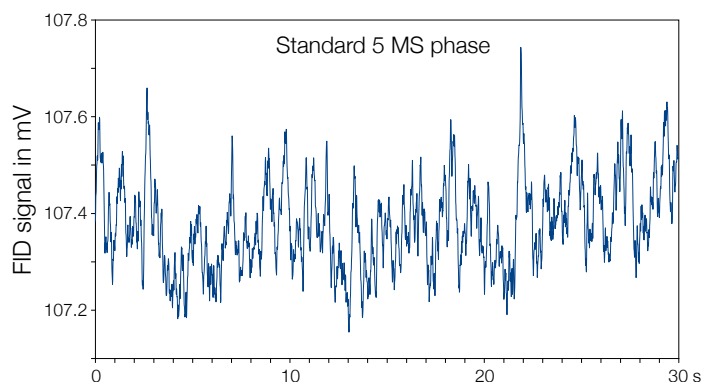

Ordering information

OPTIMA® 5 MS Accent

	Length →					
	12 m	15 m	25 m	30 m	50 m	60 m
0.2 mm ID (0.4 mm OD)						
0.20 µm film			725810.25		725810.50	
0.35 µm film	725815.12				725815.50	
0.25 mm ID (0.4 mm OD)						
0.25 µm film		725820.15		725820.30		725820.60
0.50 µm film				725825.30		725825.60
1.00 µm film				725826.30		725826.60
0.32 mm ID (0.5 mm OD)						
0.25 µm film				725811.30		725811.60
0.50 µm film				725813.30		
1.00 µm film			725812.25			725812.60

In addition to this standard program we will be happy to supply columns custom-made to your specifications. Information about scope of delivery, special cages and integrated guard columns see additional information for GC columns on page 303.



OPTIMA[®] XLB silarylene phase

★ Key features

- Chemically bonded, cross-linked silarylene phase, optimized silarylene content for lowest column bleed, nonpolar phase, perfect inertness for basic compounds, solvent rinsing for removal of impurities applicable
- Structure see page 307

✓ Recommended application

- Ideal for ion trap and quadrupole MS detectors, ultra low bleed phase, highly selective for environmental and trace analysis, pesticides, recommended phase for PCB separations

✍ Temperature

- T_{max} 340 °C (long-term temperature), T_{max} 360 °C (short-term max. temperature in a temperature program)

Similar phases

- DB-XLB, Rxi[®]-XLB, Rtx[®]-XLB, MDN-12, VF-XMS

Rapid separation of PCB and PAH

MN Appl. No. 212920

Column: OPTIMA[®] XLB, 30 m x 0.25 mm ID, 0.25 µm film
 Injection: 1 µL, Standard 0.005 ng/µL, 250 °C, pulsed, splitless, pulse 1.38 bar in 1 min
 Carrier gas: 60 mL/min He
 Temperature: 40 °C (2 min) → 240 °C (2 min), 30 °C/min → 340 °C (5 min), 10 °C/min
 Detektion: MS source 230 °C, interface 280 °C, quadrupole 150 °C

Peaks:	21. Benz[<i>a</i>]anthracene
1. Naphthalene	22. Chrysene
2. 2-Methylnaphthalene	23. PCB-169
3. Acenaphthylene	24. PCB-194
4. Acenaphthene	25. Benzo[<i>b</i>]fluoranthene
5. Fluorene	26. Benzo[<i>k</i>]fluoranthene
6. Phenanthrene	27. Benzo[<i>a</i>]pyrene
7. Anthracene	28. Dibenzo[<i>ah</i>]anthracene
8. PCB-31	29. Indeno[1,2,3- <i>cd</i>]pyrene
9. PCB-28	30. Benzo[<i>ghi</i>]perylene
10. PCB-52	
11. Fluoranthene	
12. PCB-101	
13. Pyrene	
14. PCB-77	
15. 2-Methylfluoranthene	
16. PCB-118	
17. PCB-153	
18. PCB-138	
19. PCB-126	
20. PCB-180	

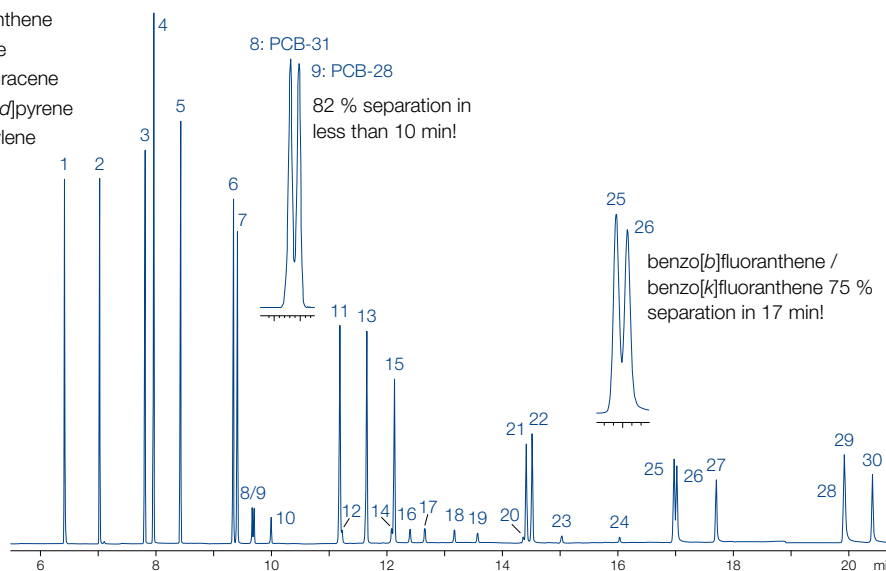

Courtesy of Centre d'Analyses de Recherche, Lab. d'Hydrologie, 65400 Illkirch, France

Ordering information

OPTIMA[®] XLB

	Length → 30 m	60 m
0.25 mm ID (0.4 mm OD)		
0.25 µm film	725850.30	725850.60

In addition to this standard program we will be happy to supply columns custom-made to your specifications. Information about scope of delivery, special cages and integrated guard columns see additional information for GC columns on page 303.



Range of polarities covered by OPTIMA® δ phases

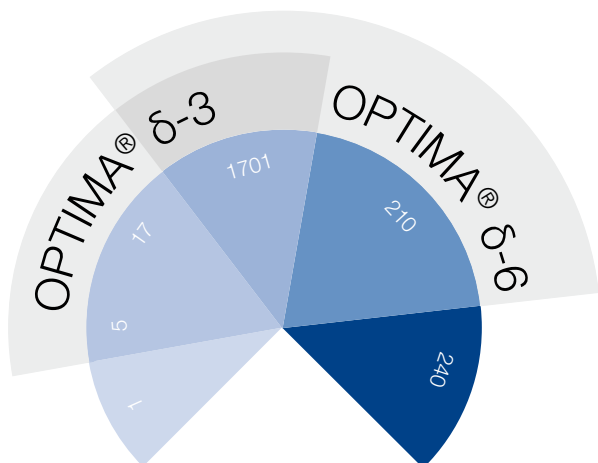

All stationary GC phases can be classified by their polarities. While the selectivity of common GC phases is generally determined by permanent dipole-dipole interactions, OPTIMA® δ -3 and OPTIMA® δ -6 show an additional feature. Large, polarizable groups in the polymer chain of the stationary phase enable the analyte to induce a further dipole moment that increases

with the polarity of said analyte. We call this phenomenon “Autoselectivity”, because the column adjusts itself to the polarity of the analyte. The implemented polymers consist of cross-linked polysiloxanes with a defined composition and an extremely narrow distribution of molecular weight.

OPTIMA® δ phases cover broad ranges of polarities. Compared with conventional phases, OPTIMA® δ -3 polarity ranges from approximately the nonpolar OPTIMA® 5 to the midpolar OPTIMA® 1701, while for OPTIMA® δ -6 the polarity covers a range from about the midpolar OPTIMA® 17 to the polar OPTIMA® 210.

OPTIMA® δ phases show high temperature limits (340 / 360 °C), as well as low bleed levels, which makes them ideal for the use with mass selective (MSD) or phosphorus/nitrogen detectors (PND) in the field of environmental trace analysis.

Isomeric phenols, such as chloro- and nitrophenols, are difficult to analyze with standard GC phases (e.g., OPTIMA® 5 or OPTIMA® 17) because of co-elutions. The autoselective OPTIMA® δ -3 is able to separate all 22 phenols due to stronger interactions occurring with more polar molecules, because polar analytes induce a dipole moment in the phase of the OPTIMA® δ -3 (see chromatogram page 319).

Separation characteristics of OPTIMA® δ phases

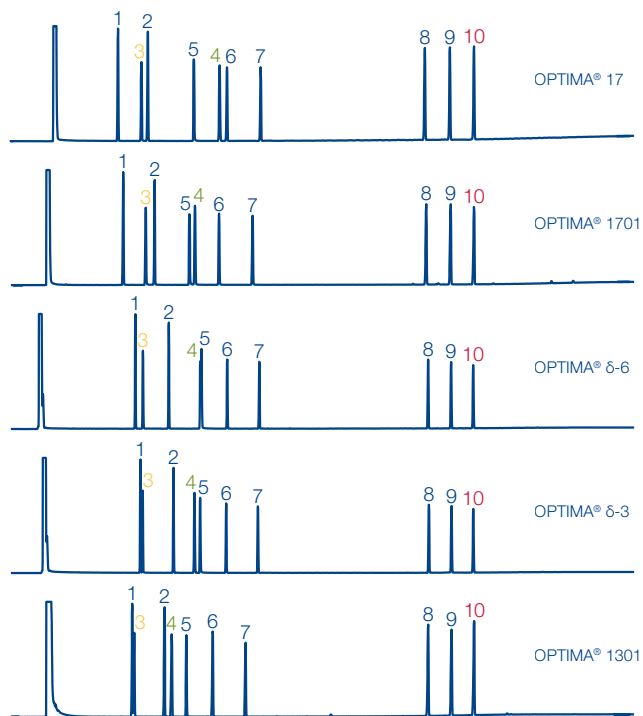

Conditions and peaks (see page 305)

Key features of OPTIMA® δ phases

- Wide range of application due to autoselectivity
- Outstanding thermal stability similar to nonpolar phases
- Low bleed levels
- Medium polar without CN groups

Ordering information about OPTIMA® δ phases can be found on page 319 and page 320.



OPTIMA® δ -3 polysiloxane phase with autoselectivity · USP G49

★ Key features

- Medium polar without CN groups
- Autoselectivity resulting in a polarity range from approximately the nonpolar OPTIMA® 5 to the midpolar OPTIMA® 1701 (see page 318)
- Analytes determine the polarity of the phase

✓ Recommended application

- Ideal for MSD and PND detectors

✍ Temperature

- 0.1–0.32 mm ID:
 T_{\max} 340 °C (long-term temperature),
 T_{\max} 360 °C (short-term max. temperature in a temperature program)
- 0.53 mm ID:
 T_{\max} 320 and 340 °C, resp.

Similar phases

- Exclusive from MN

Analysis of isomeric phenols

MN Appl. No. 250060

Column: OPTIMA® δ -3, 60 m x 0.25 mm ID, 0.25 μ m film
 Injection: 1.0 μ L, split 1:80
 Carrier gas: He, 1.3 bar
 Temperature: 60 °C (3 min) \rightarrow 320 °C, 6 °C/min
 Detector: MSD HP 5971

Peaks:

- | | |
|-----------------------------|-----------------------------------|
| 1. Phenol | 13. 2,4,5-Trichlorophenol |
| 2. 2-Chlorophenol | 14. 2,3,4-Trichlorophenol |
| 3. 2-Methylphenol | 15. 2,3,6-Trichlorophenol |
| 4. 4-Methylphenol | 16. 2,3,5,6-Tetrachlorophenol |
| 5. 3-Methylphenol | 17. 2,3,4,5-Tetrachlorophenol |
| 6. 2,4-Dimethylphenol | 18. 2,3,4,6-Tetrachlorophenol |
| 7. 2-Nitrophenol | 19. 2,4-Dinitrophenol |
| 8. 2,4-Dichlorophenol | 20. 3,4,5-Trichlorophenol |
| 9. 2,6-Dichlorophenol | 21. 2-Methyl-4,6-dinitrophenol |
| 10. 4-Chloro-3-methylphenol | 22. 2-Isopropyl-4,6-dinitrophenol |
| 11. 2,3,5-Trichlorophenol | |
| 12. 2,4,6-Trichlorophenol | |

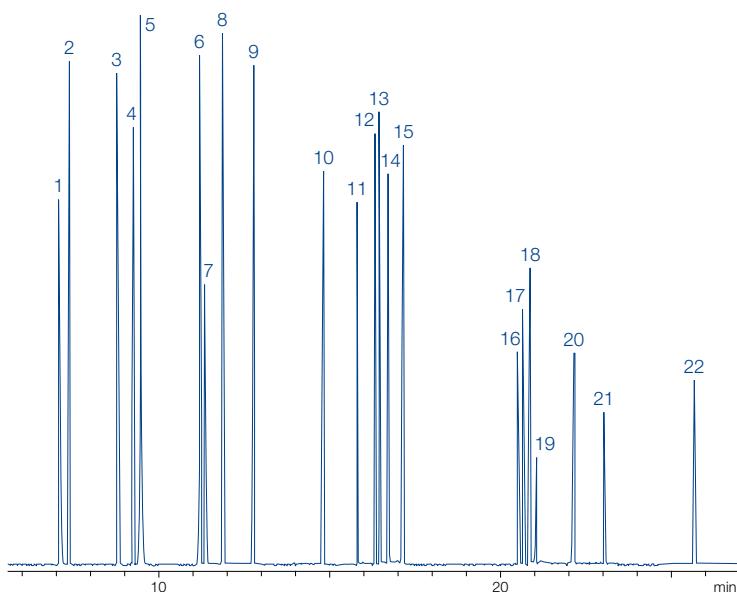

Ordering information

OPTIMA® δ -3

	Length \rightarrow					
	10 m	20 m	25 m	30 m	50 m	60 m
0.1 mm ID (0.4 mm OD)						
0.10 μ m film	726410.10	726410.20				
0.2 mm ID (0.4 mm OD)						
0.20 μ m film			726400.25		726400.50	
0.25 mm ID (0.4 mm OD)						
0.25 μ m film				726420.30		726420.60
0.50 μ m film				726421.30		
0.32 mm ID (0.5 mm OD)						
0.25 μ m film				726440.30		726440.60
0.35 μ m film				726441.30		726441.60
1.00 μ m film				726442.30		726442.60
0.53 mm ID (0.8 mm OD)						
1.00 μ m film				726443.30		

In addition to this standard program we will be happy to supply columns custom-made to your specifications. Information about scope of delivery, special cages and integrated guard columns see additional information for GC columns on page 303.



OPTIMA® δ · phases with autoselectivity

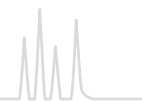

OPTIMA® δ-6 polysiloxane phase with autoselectivity

★ Key features

- Medium polar without CN groups
Autoselectivity resulting in a polarity range from approximately the midpolar OPTIMA® 17 to the polar OPTIMA® 210 (see page 318)
- Analytes determine the polarity of the phase

✓ Recommended application

- Ideal for MSD and PND detectors

✍ Temperature

- 0.1–0.32 mm ID:
T_{max} 340 °C (long-term temperature),
T_{max} 360 °C (short-term max. temperature in a temperature program)
- 0.53 mm ID:
T_{max} 320 and 340 °C, resp.

Similar phases

- Exclusive from MN

Separation of organophosphorus pesticides (EPA 8140 / 8141)

MN Appl. No. 250420

Column: OPTIMA® δ-6, 50 m x 0.2 mm ID, 0.2 µm film
 Sample: EPA 8140 OP pesticide calibration mix (Restek),
 200 µg/mL each in hexane – acetone (95:5)
 Injection: 1 µL, split 1:30
 Carrier gas: 2.0 bar He
 Temperature: 150 °C → 300 °C (10 min), 2.5 °C/min
 Detector: MSD HP 5971

Peaks:

- | | |
|----------------------|-------------------------------|
| 1. Dichlorvos | 13. Trichloronate |
| 2. Mevinphos | 14. Fenthion |
| 3. Demeton-S | 15. Merphos |
| 4. Ethoprop | 16. Stirofos |
| 5. Naled | 17. Tokuthion |
| 6. Phorate | 18. Merphos oxidation product |
| 7. Demeton-O | 19. Fensulfothion |
| 8. Diazinon | 20. Bolstar |
| 9. Disulfoton | 21. Azinphos-methyl |
| 10. Ronnel | 22. Coumaphos |
| 11. Parathion-methyl | |
| 12. Chlorpyrifos | |

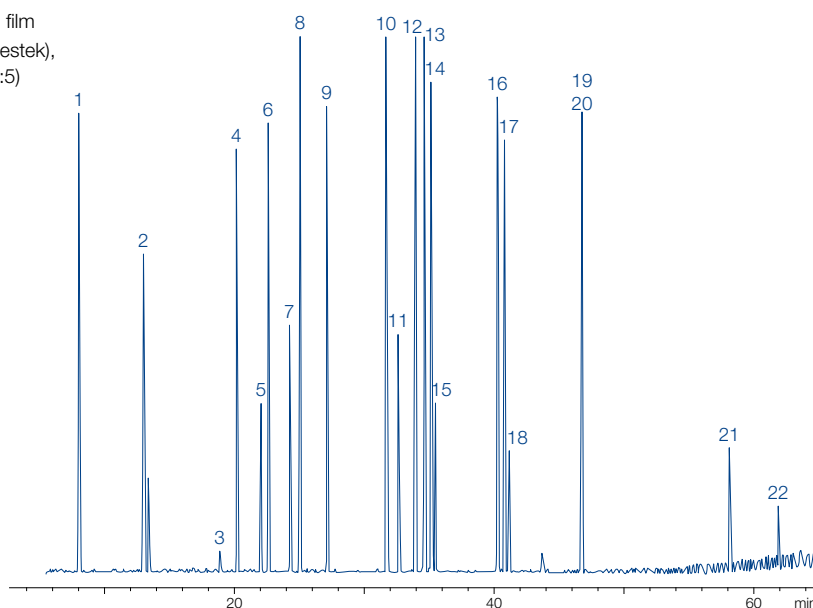

Ordering information

OPTIMA® δ-6

	Length →				
	10 m	25 m	30 m	50 m	60 m
0.1 mm ID (0.4 mm OD)					
0.10 µm film	726490.10				
0.2 mm ID (0.4 mm OD)					
0.20 µm film		726465.25		726465.50	
0.25 mm ID (0.4 mm OD)					
0.25 µm film			726470.30		726470.60
0.32 mm ID (0.5 mm OD)					
0.25 µm film			726480.30		726480.60
0.35 µm film			726481.30		726481.60
1.00 µm film			726482.30		726482.60
0.53 mm ID (0.8 mm OD)					
1.00 µm film			726483.30		

In addition to this standard program we will be happy to supply columns custom-made to your specifications. Information about scope of delivery, special cages and integrated guard columns see additional information for GC columns on page 303.

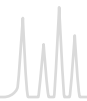

OPTIMA® 1301 6 % cyanopropyl-phenyl – 94 % dimethylpolysiloxane · USP G43

★ Key features

- Midpolar phase
- Structure see page 307

✓ Recommended application

- Pesticide analysis
- For corresponding columns with higher film thickness see OPTIMA® 624

✍ Temperature

- T_{max} 300 °C (long-term temperature), T_{max} 320 °C (short-term max. temperature in a temperature program)

Similar phases

- HP-1301, DB-1301, SPB™-1301, Rtx®-1301, CP-1301, 007-1301

Analysis of a pesticide mixture

MN Appl. No. 210620

Column: OPTIMA® 1301, 60 m x 0.25 mm ID, 0.25 µm film
 Injection: 3 µL (0.1 ng/µL), 80 °C (1 min) → 250 °C (1 min) pulsed splitless
 Carrier gas: He, 54 mL/min
 Temperature: 80 °C (2 min) → 190 °C, 20 °C/min (12 min) → 240 °C, 2 °C/min (23 min) → 260 °C, 10 °C/min (20 min)
 Detector: ECD

Peaks :

1. Propyzamide
2. Vinclozolin
3. Bromophos-ethyl
4. 2,4-DDT
5. Brompropylate

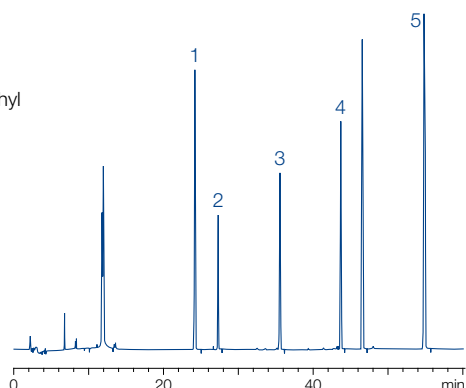

Analysis of a PCB mixture

MN Appl. No. 210650

Column: OPTIMA® 1301, 60 m x 0.25 mm ID, 0.25 µm film
 Injection: 3 µL (0.1 ng/µL), 80 °C (1 min) → 250 °C (1 min) pulsed splitless
 Carrier gas: He, 54 mL/min
 Temperature: 80 °C (2 min) → 190 °C, 20 °C/min (12 min) → 240 °C, 2 °C/min (23 min) → 260 °C, 10 °C/min (20 min)
 Detector: ECD

Peaks :

1. PCB-28
2. PCB-52
3. PCB-128
4. PCB-153
5. PCB-138
6. PCB-180

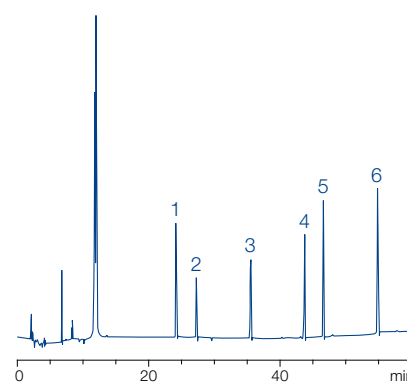

Ordering information

OPTIMA® 1301

	Length →			
	25 m	30 m	50 m	60 m
0.25 mm ID (0.4 mm OD)				
0.25 µm film	726771.25	726771.30	726771.50	726771.60
0.32 mm ID (0.5 mm OD)				
0.25 µm film	726777.25	726777.30		726777.60
1.00 µm film		726780.30	726780.50	726780.60
0.53 mm ID (0.8 mm OD)				
1.00 µm film	726783.25			

In addition to this standard program we will be happy to supply columns custom-made to your specifications. Information about scope of delivery, special cages and integrated guard columns see additional information for GC columns on page 303.

Further applications can be found online in our application database at www.mn-net.com/apps



OPTIMA® 1301 MS 6 % cyanopropyl-phenyl – 94 % dimethylpolysiloxane · USP G43

★ Key features

- Chemically bonded, cross-linked silarylene phase with selectivity similar to 6 % cyanopropyl-phenyl – 94 % dimethylpolysiloxane, symmetric substituted cyanopropylsilanes and integrated phenyl rings (silarylene)
- Midpolar phase with very low bleed
- Perfect deactivation
- Structure see page 307

✓ Recommended application

- Specially suitable for sophisticated environmental analysis (e.g., EPA methods for PAHs, PCBs and pesticides)
- 100 % ion trap and quadrupol MS compatibility

✍ Temperature

- T_{max} 300 °C (long-term temperature), T_{max} 320 °C (short-term max. temperature in a temperature program)

Similar phases

- VF-1301ms, Rxi®-1301Sil MS, TG-1301MS

Ordering information

OPTIMA® 1301 MS

	Length → 30 m	60 m
0.25 mm ID (0.4 mm OD)		
0.25 µm film	726640.30	726640.60
0.32 mm ID (0.5 mm OD)		
0.25 µm film	726641.30	726641.60
1.00 µm film	726642.30	726642.60
0.53 mm ID (0.8 mm OD)		
1.00 µm film	726643.30	726643.60

In addition to this standard program we will be happy to supply columns custom-made to your specifications. Information about scope of delivery, special cages and integrated guard columns see additional information for GC columns on page 303.



OPTIMA® · medium polar capillary columns



OPTIMA® 624 6 % cyanopropyl-phenyl – 94 % dimethylpolysiloxane · USP G43

★ Key features

- Midpolar phase
- Structure see page 307

✓ Recommended application

- Environmental analysis
- For corresponding columns with low-film thickness see OPTIMA® 1301

✍ Temperature

- T_{max} 280 °C (long-term temperature), T_{max} 300 °C (short-term max. temperature in a temperature program)

Similar phases

- HP-624, HP-VOC, DB-624, DB-VRX, SPB™-624, CP-624, Rtx®-624, Rtx®-Volatiles, 007-624, BP624, VOCOL

OPTIMA® 624 LB 6 % cyanopropyl-phenyl – 94 % dimethylpolysiloxane

★ Key features

- Midpolar phase with low bleeding
- Structure see page 307

✓ Recommended application

- Halogenated hydrocarbons, volatiles, aromatic compounds, solvents etc.

Solvents and semi-volatiles

MN Appl. No. 212520

Column: OPTIMA® 624 LB, 30 m x 0.32 mm ID, 1.8 µm film; retention gap Phe-Sil 0.5 m x 0.53 mm
 Injection: 1 µL (10 ppm per substance in acetone), cold on-column
 Carrier gas: 1.1 bar He
 Temperature: 45 °C (3 min) → 150 °C (6 °C/min) → 300 °C (18 °C/min), 20 min 300 °C
 Detector: FID 280 °C

Peaks:

- | | |
|-----------------------|---------------------------------------|
| 1. Acetone | 11. Decane |
| 2. Ethyl acetate | 12. 1-Octanol |
| 3. Tetrahydrofuran | 13. Acetophenone |
| 4. Cyclohexane | 14. Butyrophenone |
| 5. 2-Methyl-2-butanol | 15. Heptanophenone |
| 6. 1-Butanol | 16. 5-Methoxyindole |
| 7. Pyridine | 17. Dibenzylamine |
| 8. Toluene | 18. Methyl eicosanoate |
| 9. Dimethylformamide | 19. Methyl <i>cis</i> -13-docosenoate |
| 10. Dimethylsulfoxide | 20. Methyl docosanoate |

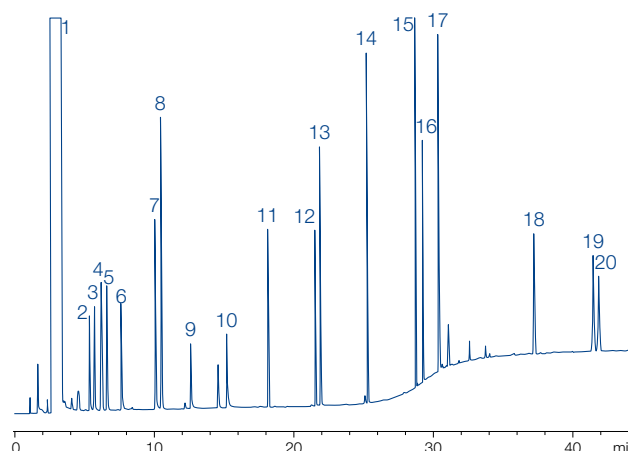

Ordering information

	Length →			
	25 m	30 m	50 m	60 m
OPTIMA® 624				
0.2 mm ID (0.4 mm OD)				
1.10 µm film	726784.25			
0.25 mm ID (0.4 mm OD)				
1.40 µm film	726785.25	726785.30	726785.50	726785.60
0.32 mm ID (0.5 mm OD)				
1.80 µm film	726787.25	726787.30	726787.50	726787.60
0.53 mm ID (0.8 mm OD)				
3.00 µm film	726789.25	726789.30		
OPTIMA® 624 LB				
0.32 mm ID (0.5 mm OD)				
1.80 µm film		726786.30	726786.50	

In addition to this standard program we will be happy to supply columns custom-made to your specifications. Information about scope of delivery, special cages and integrated guard columns see additional information for GC columns on page 303.



OPTIMA[®] · medium polar capillary columns

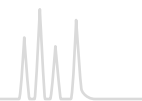

OPTIMA[®] 1701 14 % cyanopropyl-phenyl – 86 % dimethylpolysiloxane · USP G46

★ Key features

- Midpolar phase, special selectivity due to high cyanopropyl content
- Structure see page 307

✓ Recommended application

- Reference column for structure identification, e.g., in combination with OPTIMA[®] 5
- Film thickness $\geq 1 \mu\text{m}$ for solvent analysis

✍ Temperature

- T_{max} 280 °C (long-term temperature), T_{max} 300 °C (short-term max. temperature in a temperature program)
- 0.53 mm ID: T_{max} 280 and 300 °C, resp.

Similar phases

- OV-1701, DB-1701, CP-Sil 19 CB, HP-1701, Rtx[®]-1701, SPB[™]-1701, 007-1701, BP10, ZB-1701

Analysis of aromatic hydrocarbons

MN Appl. No. 200400

Column: OPTIMA[®] 1701, 25 m x 0.32 mm ID, 0.25 μm film
 Injection: 1 μL , split 1:40
 Carrier gas: 0.6 bar N_2
 Temperature: 60 °C \rightarrow 120 °C, 4 °C/min
 Detector: FID 260 °C

Peaks:

1. Benzene
2. Toluene
3. Ethylbenzene
4. *p*-Xylene
5. *o*-Xylene
6. Phenol
7. 2-Methylphenol
8. 2,6-Dimethylphenol
9. 4-Methylphenol
10. 2,4-Dimethylphenol
11. 2,4,6-Trimethylphenol

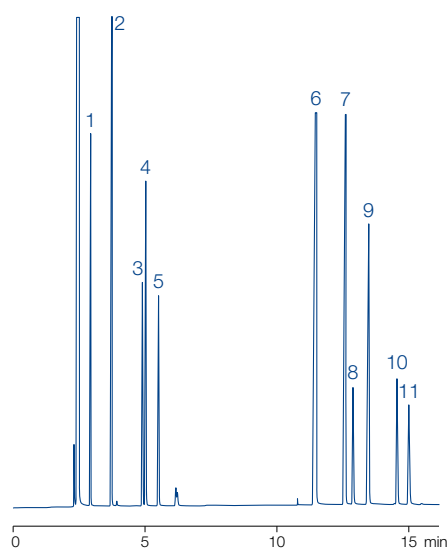

Ordering information

OPTIMA[®] 1701

	Length \rightarrow					
	10 m	15 m	25 m	30 m	50 m	60 m
0.2 mm ID (0.4 mm OD)						
0.20 μm film			726841.25		726841.50	
0.25 mm ID (0.4 mm OD)						
0.25 μm film	726058.10	726058.15	726058.25	726058.30	726058.50	726058.60
0.50 μm film				726064.30		726064.60
1.00 μm film				726965.30		
0.32 mm ID (0.5 mm OD)						
0.25 μm film	726318.10	726318.15	726318.25	726318.30	726318.50	726318.60
0.35 μm film			726824.25	726824.30	726824.50	726824.60
0.50 μm film			726320.25	726320.30	726320.50	726320.60
1.00 μm film			726929.25	726929.30	726929.50	726929.60
0.53 mm ID (0.8 mm OD)						
1.00 μm film	726545.10	726545.15	726545.25	726545.30		
2.00 μm film		726735.15	726735.25	726735.30	726735.50	

In addition to this standard program we will be happy to supply columns custom-made to your specifications. Information about scope of delivery, special cages and integrated guard columns see additional information for GC columns on page 303.

Further applications can be found online in our application database at www.mn-net.com/apps

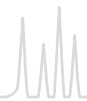

OPTIMA[®] 1701 MS silarylene phase · USP G46

★ Key features

- Chemically bonded, cross-linked silarylene phase with selectivity similar to 14 % cyanopropyl-phenyl – 86 % dimethylpolysiloxane, symmetric substituted cyanopropylsilanes and integrated phenyl rings (silarylene)
- Midpolar phase with very low bleed
- Perfect deactivation
- Structure see page 307

✓ Recommended application

- Environmental analysis (e.g., PAHs, PCBs, pesticides)
- Reference column for structure identification, e.g., in combination with OPTIMA[®] 5 MS
- 100 % ion trap and quadrupole MS compatibility

✍ Temperature

- T_{max} 280 °C (long-term temperature), T_{max} 300 °C (short-term max. temperature in a temperature program)

Similar phases

- VF-1701ms, TG-1701MS, OV-1701, DB-1701, HP-1701, Rtx[®]-1701, SPB[™]-1701, CP Sil 19 CB, 007-1701, BP10, ZB-1701

Separation of triazine pesticides (EPA 619)

MN Appl. No. 215080

Column: OPTIMA[®] 1701 MS, 30 m x 0.25 mm ID, 0.25 µm film
 Injection: 1 µL, 250 °C, split 1:100
 Carrier gas: 42 cm/s He
 Temperature: 160 °C (1 min) → 180 °C, 15 °C/min → 220 °C, 2 °C/min
 Detector: MSD

Peaks:

1. Prometon
2. Atraton
3. Propazine
4. Atrazine
5. Simazine
6. Terbutylazine
7. Secbumeton
8. Prometryn
9. Ametryn
10. Simetryn
11. Terbutryn

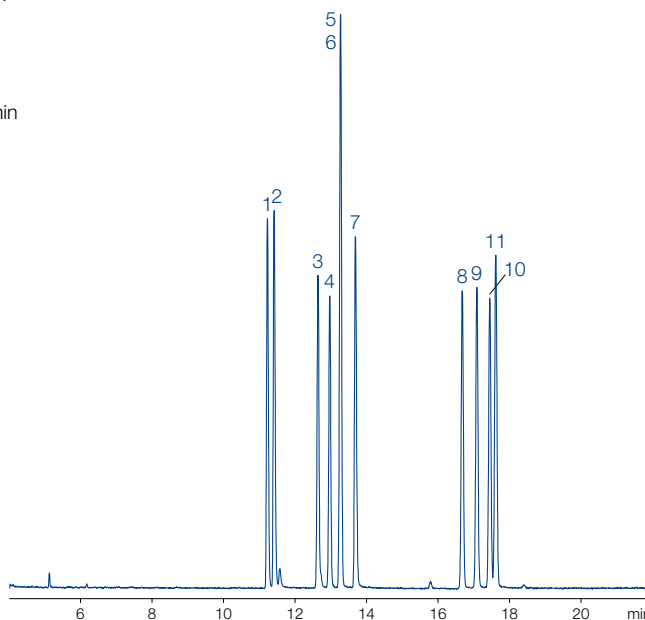

Ordering information

OPTIMA[®] 1701 MS

	Length →	
	30 m	60 m
0.25 mm ID (0.4 mm OD)		
0.25 µm film	726630.30	726630.60
0.50 µm film	726631.30	726631.60
1.00 µm film	726632.30	726632.60
0.32 mm ID (0.5 mm OD)		
0.25 µm film	726633.30	726633.60
0.50 µm film	726634.30	726634.60
1.00 µm film	726635.30	726635.60

In addition to this standard program we will be happy to supply columns custom-made to your specifications. Information about scope of delivery, special cages and integrated guard columns see additional information for GC columns on page 303.



OPTIMA[®] · medium polar capillary columns



OPTIMA[®] 35 MS silarylene phase · USP G42 / close equivalent to USP G28 / G32

★ Key features

- Chemically bonded cross-linked silarylene phase with selectivity similar to 35 % phenyl – 65 % methyl polysiloxane, midpolar phase, polymer without CN groups
- Very low column bleeding
- Structure see page 309

✓ Recommended application

- Ideal for ion trap detectors
- Optimum column for confirmation of analytical results in combination with a 1 MS or 5 MS
- All-round phase for environmental analysis, ultra trace analysis, EPA methods, pesticides, PCB, food and drug analysis

✍ Temperature

- T_{max} 360 °C (long-term temperature), T_{max} 370 °C (short-term max. temperature in a temperature program)

Similar phases

- DB-35 MS, HP-35, SPB[™]-35, Rxi[®]-35SIL MS, Rtx-35, 007-35, BPX[™]-35, MDN-35, AT[™]-35 MS, ZB-35, OV-11, VF-35 MS

PAH in accordance with EPA 610

MN Appl. No. 213190

Column: OPTIMA[®] 35 MS, 30 m x 0.25 mm ID, 0.25 µm film
 Injection: 1 µL, split 1:10
 Carrier gas: 0.6 bar H₂
 Temperature: 100 °C (3 min) → 300 °C (10 min), 6 °C/min
 Detector: MSD

Peaks

1. Naphthalene
2. Acenaphthylene
3. Acenaphthene
4. Fluorene
5. Phenanthrene
6. Anthracene
7. Fluoranthene
8. Pyrene
9. Benz[a]anthracene
10. Chrysene
11. Benzo[b]fluoranthene
12. Benzo[k]fluoranthene
13. Benzo[a]pyrene
14. Indeno[1,2,3-*cd*]pyrene
15. Dibenz[*ah*]anthracene
16. Benzo[*ghi*]perylene

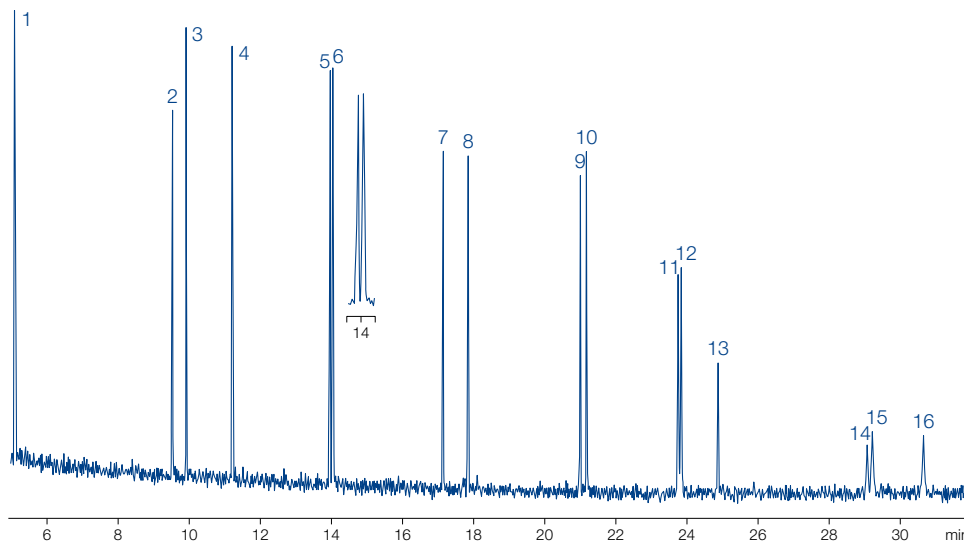

Ordering information

OPTIMA[®] 35 MS

	Length → 30 m	60 m
0.25 mm ID (0.4 mm OD)		
0.25 µm film	726154.30	726154.60
0.32 mm ID (0.5 mm OD)		
0.25 µm film	726157.30	726157.60

In addition to this standard program we will be happy to supply columns custom-made to your specifications. Information about scope of delivery, special cages and integrated guard columns see additional information for GC columns on page 303.

Further applications can be found online in our application database at www.mn-net.com/apps

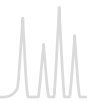

OPTIMA® · medium polar capillary columns



OPTIMA® 17 phenylmethylpolysiloxane (50 % phenyl) · USP G3

★ Key features

- Midpolar phase
- Structure see page 309

✓ Recommended application

- Steroids, pesticide, drug analysis

✍ Temperature

- T_{max} 320 °C (long-term temperature), T_{max} 340 °C (short-term max. temperature in a temperature program)
- 0.53 mm ID: T_{max} 300 and 320 °C resp.

Similar phases

- OV-17, DB-17, HP-50+, HP-17, SPB™-50, SP-2250, Rxi®-17, Rtx®-50, CP-Sil 24 CB, 007-17, ZB-50

Analysis of pesticides

MN Appl. No. 200930

Column: OPTIMA® 17, 25 m x 0.2 mm ID, 0.20 µm film
 Sample: pesticides, standard of the cantonal laboratory Schaffhausen (Switzerland), 0.1 mg/mL or 0.01 mg/mL each
 Injection: 1.0 µL, 3 s without split
 Carrier gas: He, 25 cm/s
 Temperature: 100 °C (3 min), 8 °C/min → 250 °C, 10 °C/min → 320 °C
 Detector: MSD HP 5971

Peaks:

- | | |
|------------------|---------------------|
| 1. Dichlorphos | 8. Captan |
| 2. Naled | 9. Folpet |
| 3. Vinclozolin | 10. Carbophenothion |
| 4. Chlorthalonil | 11. Iprodion |
| 5. Chlorpyrifos | 12. Captafol |
| 6. Dichlofluanid | 13. Coumaphos |
| 7. Procymidon | |

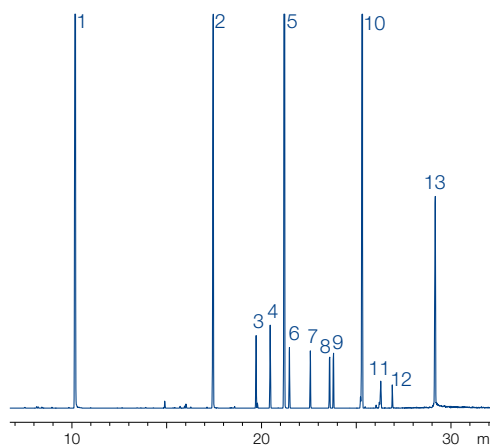

Ordering information

OPTIMA® 17

	Length →						
	10 m	12 m	15 m	25 m	30 m	50 m	60 m
0.1 mm ID (0.4 mm OD)							
0.10 µm film	726848.10						
0.2 mm ID (0.4 mm OD)							
0.20 µm film		726065.12		726065.25		726065.50	
0.50 µm film				726066.25		726066.50	
0.25 mm ID (0.4 mm OD)							
0.15 µm film				726742.25	726742.30	726742.50	726742.60
0.25 µm film			726022.15	726022.25	726022.30	726022.50	726022.60
0.50 µm film				726067.25	726067.30	726067.50	726067.60
0.32 mm ID (0.5 mm OD)							
0.15 µm film					726755.30		
0.25 µm film				726351.25	726351.30	726351.50	726351.60
0.35 µm film				726757.25	726757.30	726757.50	726757.60
0.50 µm film				726744.25	726744.30	726744.50	726744.60
0.53 mm ID (0.8 mm OD)							
1.00 µm film	726747.10		726747.15	726747.25	726747.30		

In addition to this standard program we will be happy to supply columns custom-made to your specifications. Information about scope of delivery, special cages and integrated guard columns see additional information for GC columns on page 303.

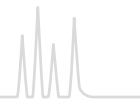

OPTIMA[®] 17 MS silarylene phase · USP G3

★ Key features

- Medium polar silarylene phase with selectivity analogue to 50 % phenyl – 50 % methylpolysiloxane, no CN groups in the polymer
- Structure see page 309

✓ Recommended application

- Ideal for ion trap detectors
- Optimum reference column in combination with a 1 MS or 5 MS
- All-round phase for environmental analysis, ultra-trace analysis, EPA methods, pesticide, PCBs, food and drug analysis

✍ Temperature

- T_{max} 340 °C (long-term temperature),
- T_{max} 360 °C (short-term max. temperature in a temperature program)

Similar phases

- OV-17, AT[™]-50, BPX[™]-50, DB-17, DB-17ms, HP-50+, HP-17, SPB[™]-50, SPB[™]-17, SP-2250, Rtx[®]-50, CP-Sil 24 CB, 007-17, VF-17ms, ZB-50

Analysis of phenols

MN Appl. No. 213600

Column: OPTIMA[®] 17 MS, 30 m x 0.25 mm ID, 0.25 µm film
 Sample: phenol mix 604
 Injection: 1.0 µL, 230 °C, split 1:30
 Carrier gas: 0.8 bar He
 Temperature: 100 °C, 10 °C/min → 250 °C
 Detector: FID 280 °C

Peaks:

1. Phenol
2. 2-Chlorophenol
3. 2,4-Dimethylphenol
4. 2-Nitrophenol
5. 2,4-Dichlorophenol
6. 4-Chloro-3-methylphenol
7. 2,4,6-Trichlorophenol
8. 4-Nitrophenol
9. 2,4-Dinitrophenol
10. 2-Methyl-4,6-dinitrophenol
11. Pentachlorophenol

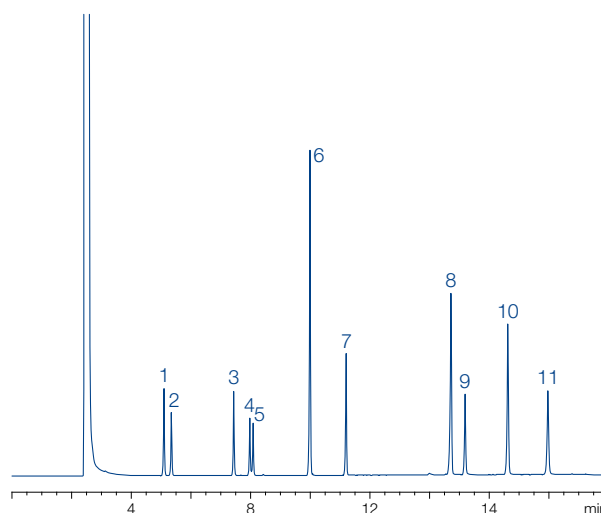

Ordering information

OPTIMA[®] 17 MS

	Length → 30 m	60 m
0.25 mm ID (0.4 mm OD)		
0.25 µm film	726162.30	726162.60
0.32 mm ID (0.5 mm OD)		
0.25 µm film	726165.30	726165.60

In addition to this standard program we will be happy to supply columns custom-made to your specifications. Information about scope of delivery, special cages and integrated guard columns see additional information for GC columns on page 303.

Further applications can be found online in our application database at www.mn-net.com/apps



OPTIMA[®] 210 trifluoropropyl-methylpolysiloxane (50 % trifluoropropyl) · close equivalent to USP G6

★ Key features

- Midpolar phase
- Structure see page 309

✓ Recommended application

- Environmental analysis, especially for *o*-, *m*- and *p*-substituted aromatic hydrocarbons

✍ Temperature

- T_{max} 260 °C (long-term temperature), T_{max} 280 °C (short-term max. temperature in a temperature program)

Similar phases

- OV-210, DB-210, Rtx[®]-200, 007-210

Aromatic hydrocarbons (BTX)

MN Appl. No. 200230

Column: OPTIMA[®] 210, 50 m x 0.25 mm ID, 0.5 µm film
 Injection: 0.5 µL, split 105 mL/min
 Carrier gas: 130 kPa N₂ (1.1 mL/min)
 Temperature: 50 °C
 Detector: FID 250 °C

Peaks:

1. Benzene
2. Toluene
3. Ethylbenzene
4. *p*-Xylene
5. *m*-Xylene
6. *o*-Xylene

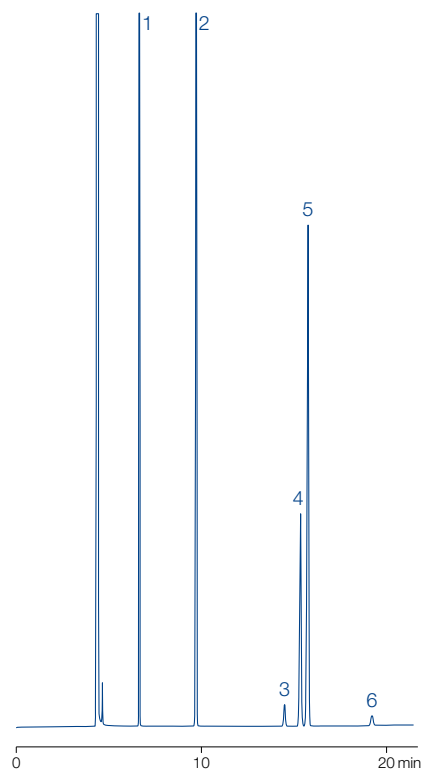

Ordering information

OPTIMA[®] 210

	Length →				
	15 m	25 m	30 m	50 m	60 m
0.25 mm ID (0.4 mm OD)					
0.25 µm film	726871.15	726871.25	726871.30	726871.50	726871.60
0.50 µm film			726874.30	726874.50	726874.60
0.32 mm ID (0.5 mm OD)					
0.25 µm film	726877.15		726877.30	726877.50	726877.60
0.50 µm film		726880.25	726880.30	726880.50	726880.60

In addition to this standard program we will be happy to supply columns custom-made to your specifications. Information about scope of delivery, special cages and integrated guard columns see additional information for GC columns on page 303.

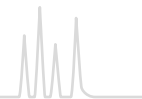

OPTIMA® 225 50 % cyanopropyl-methyl – 50 % phenylmethylpolysiloxane · close equivalent to USP G7 / G19

★ Key features

- Midpolar phase
- Structure see page 309

✓ Recommended application

- Fatty acid analysis

✍ Temperature

- T_{max} 260 °C (long-term temperature),
T_{max} 280 °C (short-term max. temperature in a temperature program)

Similar phases

- OV-210, DB-210, Rtx®-200, 007-210

Analysis of FAME in porcine fat

MN Appl. No. 210060

Column: OPTIMA® 225, 25 m x 0.32 mm ID, 0.25 µm film

Injection: 1 µL, split 1:40

Carrier gas: 60 kPa H₂

Temperature: 50 °C (2 min) → 125 °C, 30 °C/min → 160 °C, 5 °C/min → 180 °C, 20 °C/min → 200 °C, 3 °C/min → 220 °C, 20 °C/min (10 min)

Detector: FID 260 °C

Peaks:

- | | |
|-----------|-----------|
| 1. C4:0 | 18. C18:0 |
| 2. C5:0 | 19. C18:1 |
| 3. C6:0 | 20. C18:2 |
| 4. C8:0 | 21. C18:3 |
| 5. C10:0 | 22. C19:0 |
| 6. C11:0 | 23. C20:0 |
| 7. C12:0 | 24. C20:1 |
| 8. C13:0 | 25. C20:2 |
| 9. C13:1 | 26. C20:4 |
| 10. C14:0 | 27. C20:3 |
| 11. C14:1 | 28. C20:5 |
| 12. C15:0 | 29. C22:0 |
| 13. C15:1 | 30. C22:1 |
| 14. C16:0 | 31. C22:2 |
| 15. C16:1 | 32. C22:6 |
| 16. C17:0 | 33. C24:0 |
| 17. C17:1 | 34. C24:1 |

FAME Standard

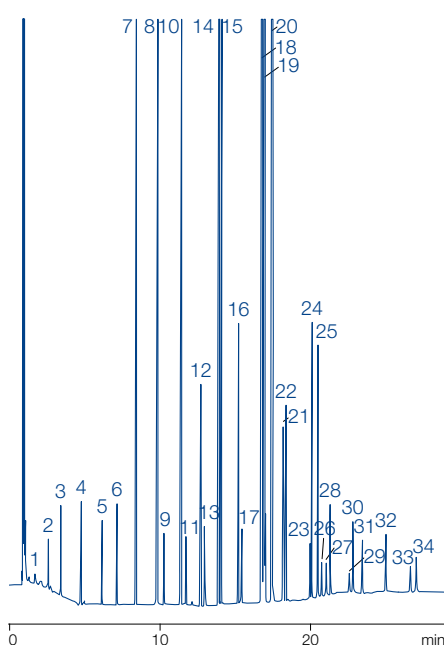

FAME in porcine fat

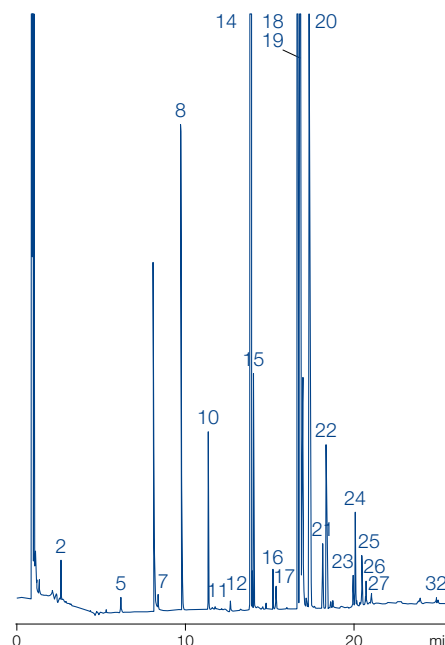

Courtesy of Dr. Bantleon, Mr. Leusche, Mr. Hagemann, VFG-Labor, Versmold, Germany

Ordering information

OPTIMA® 225

Length →	Length →					
	10 m	15 m	25 m	30 m	50 m	60 m
0.1 mm ID (0.4 mm OD)						
0.10 µm film	726080.10					
0.25 mm ID (0.4 mm OD)						
0.25 µm film		726118.15	726118.25	726118.30	726118.50	726118.60
0.32 mm ID (0.5 mm OD)						
0.25 µm film			726352.25	726352.30	726352.50	726352.60

In addition to this standard program we will be happy to supply columns custom-made to your specifications. Information about scope of delivery, special cages and integrated guard columns see additional information for GC columns on page 303.



OPTIMA[®] 240 33 % cyanopropyl-methyl – 67 % dimethylpolysiloxane

★ Key features

- Midpolar phase
- Structure see page 309

✓ Recommended application

- FAMES, dioxins

✍ Temperature

- T_{max} 260 °C (long-term temperature),
T_{max} 280 °C (short-term max. temperature in a temperature program)

Fatty acid methyl esters *cis/trans* C18:1 (FAME)

MN Appl. No. 201620

Column: OPTIMA[®] 240, 60 m x 0.25 mm ID, 0.25 µm film
 Sample: FAME mixture
 Injection: 1.0 µL, split 1:25
 Carrier gas: 150 kPa H₂
 Temperature: 80 °C → 120 °C, 20 °C/min → 260 °C (10 min), 3 °C/min
 Detector: FID 280 °C

Peaks:

- | | |
|-------------------------|-----------------------|
| 1. C4:0 | 18. <i>cis</i> -C18:1 |
| 2. C5:0 | 19. C18:2 |
| 3. C8:0 | 20. C18:3 |
| 4. C10:0 | 21. C18:3 |
| 5. C11:0 | 22. C20:0 |
| 6. C12:0 | 23. C20:1 |
| 7. C13:0 | 24. C20:2 |
| 8. C14:0 | 25. C20:3 |
| 9. C14:1 | 26. C20:4 |
| 10. C15:0 | 27. C20:3 |
| 11. C15:1 | 28. C22:0 |
| 12. C16:0 | 29. C22:1 |
| 13. C16:1 | 30. C22:3 |
| 14. C17:0 | 31. C24:1 |
| 15. C17:1 | |
| 16. C18:0 | |
| 17. <i>trans</i> -C18:1 | |

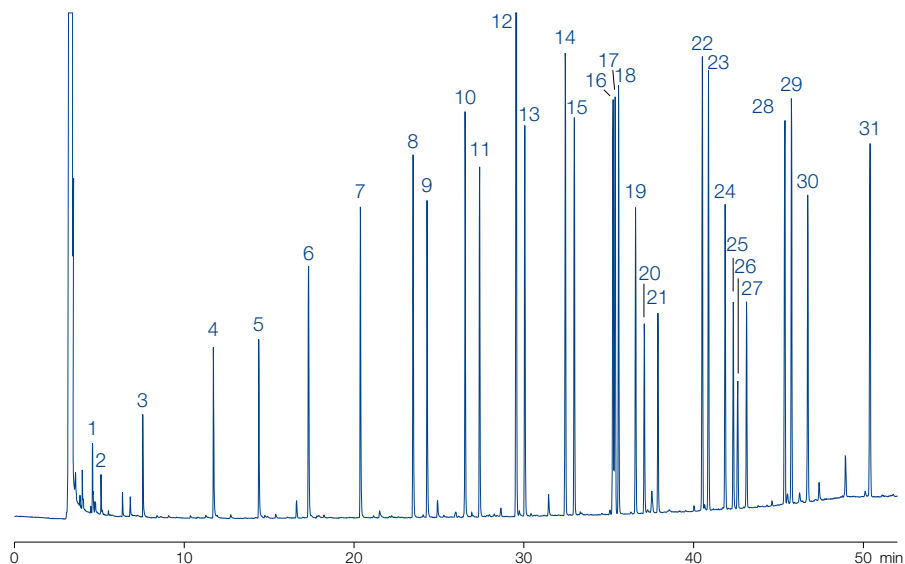

Ordering information

OPTIMA[®] 240

	Length → 25 m	30 m	50 m	60 m
0.25 mm ID (0.4 mm OD)				
0.25 µm film		726089.30	726089.50	726089.60
0.50 µm film		726090.30		726090.60
0.32 mm ID (0.5 mm OD)				
0.25 µm film	726091.25	726091.30	726091.50	726091.60
0.35 µm film		726095.30		726095.60
0.50 µm film		726096.30		726096.60

In addition to this standard program we will be happy to supply columns custom-made to your specifications. Information about scope of delivery, special cages and integrated guard columns see additional information for GC columns on page 303.

Further applications can be found online in our application database at www.mn-net.com/apps

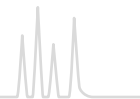

OPTIMA[®] WAX polyethylene glycol 20 000 Da · USP G16

★ Key features

- Polar phase
- Structure see page 309

✓ Recommended application

- Solvent analysis and alcohols, suitable for aqueous solutions

✍ Temperature

- T_{max} 240 °C (long-term temperature), T_{max} 250 °C (short-term max. temperature in a temperature program)
- 0.53 mm ID: T_{max} 220 and 240 °C resp.

Similar phases

- PERMABOND[®] CW 20 M (see page 337), DB-Wax, Supelcowax, HP-Wax, HP-INNOWAX, Rtx-Wax, CP-Wax 52 CB, Stabilwax, 007-CW, BP20, AT-Wax, ZB-Wax

Modified Grob test

MN Appl. No. 211170

Column: OPTIMA[®] WAX, 50 m x 0.32 mm ID, 0.5 µm film
 Injection: 1 µL, split 1:20
 Carrier gas: 1,2 bar He
 Temperature: 80 °C → 250 °C, 8 °C/min
 Detector: FID 250 °C

Peaks:

1. Decane
2. Undecane
3. Octanol
4. Methyl decanoate
5. Dicyclohexylamine
6. Methyl undecanoate
7. Methyl dodecanoate
8. 2,6-Dimethylaniline
9. 2,6-Dimethylphenol

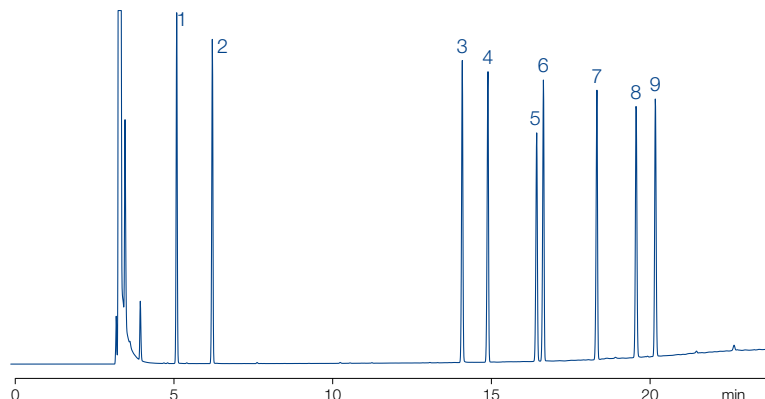

Ordering information

OPTIMA[®] WAX

	Length → 25 m	30 m	50 m	60 m
0.25 mm ID (0.4 mm OD)				
0.25 µm film	726600.25	726600.30	726600.50	726600.60
0.32 mm ID (0.5 mm OD)				
0.25 µm film	726321.25	726321.30	726321.50	726321.60
0.50 µm film	726296.25	726296.30	726296.50	726296.60
0.53 mm ID (0.8 mm OD)				
1.00 µm film	726549.25	726549.30		
2.00 µm film		726548.30		

In addition to this standard program we will be happy to supply columns custom-made to your specifications. Information about scope of delivery, special cages and integrated guard columns see additional information for GC columns on page 303.

Further applications can be found online in our application database at www.mn-net.com/apps



OPTIMA WAXplus[®] cross-linked polyethylene glycol · USP G16

★ Key features

- Polar phase with improved cross-linking for lower column bleed and better temperature stability
- Structure see page 309

✓ Recommended application

- Broad range of application, e.g., for solvents and alcohols, suitable for aqueous solutions

✍ Temperature

- T_{max} 260 °C (long-term temperature), T_{max} 270 °C (short-term max. temperature in a temperature program)

Similar phases

- DB-Wax, Supelcowax, HP-Wax, HP-INNOWAX, Rtx-Wax, CP-Wax 52 CB, Stabilwax, 007-CW, BP20, AT-Wax, ZB-Wax

Alcohols

MN Appl. No. 214160

Column: OPTIMA WAXplus[®], 30 m x 0.25 mm ID, 0.5 µm film
 Injection: 0.1 µL, split 1:80
 Carrier gas: 1.3 bar He
 Temperature: 40 °C → 260 °C, 12 °C/min (15 min)
 Detector: FID 260 °C

Peaks:

1. Methanol
2. 2-Propanol
3. Ethanol
4. 1-Propanol
5. 2-Methyl-1-propanol
6. 1-Butanol
7. 4-Methyl-2-pentanol
8. 1-Pentanol
9. 2-Methyl-1-pentanol
10. 1-Hexanol
11. Cyclohexanol
12. 1-Heptanol

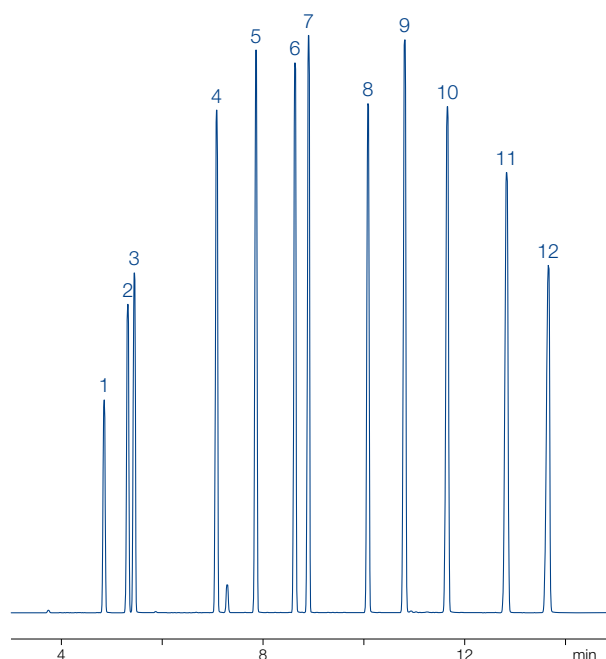

Ordering information

OPTIMA WAXplus[®]

	Length →	
	30 m	60 m
0.25 mm ID (0.4 mm OD)		
0.25 µm film	726380.30	726380.60
0.50 µm film	726381.30	726381.60
0.32 mm ID (0.5 mm OD)		
0.25 µm film	726382.30	726382.60
0.50 µm film	726383.30	726383.60

In addition to this standard program we will be happy to supply columns custom-made to your specifications. Information about scope of delivery, special cages and integrated guard columns see additional information for GC columns on page 303.



OPTIMA[®] FFAP polyethylene glycol 2-nitroterephthalate · USP G35 / close equivalent to USP G25

★ Key features

- Polar phase (FFAP = Free Fatty Acid Phase)
- Structure see page 309

✓ Recommended application

- Fatty acid methyl esters (FAMES), free carboxylic acids

✍ Temperature

- 0.10–0.32 mm ID:
 - T_{max} 250 °C (long-term temperature),
 - T_{max} 260 °C (short-term max. temperature in a temperature program)
- 0.53 mm ID: T_{max} 220 and 240 °C, resp.

Similar phases

- PERMABOND[®] FFAP (see page 338), DB-FFAP, HP-FFAP, CP-Wax 58 FFAP CB, 007-FFAP, CP-FFAP CB, Nukol[™], AT-1000, SPB-1000, BP21, OV-351

FAME test

MN Appl. No. 211140

Column: OPTIMA[®] FFAP, 60 m x 0.32 mm ID, 0.25 µm film
 Injection: 1.0 µL, 220 °C, split 1:40
 Carrier gas: 1.2 bar He
 Temperature: 55 °C → 250 °C, 6 °C/min
 Detector: FID 220 °C

Peaks:

1. C4
2. C6
3. C8
4. C10
5. C12
6. C14
7. C16
8. C18
9. C18:1 *cis/trans*
10. C18:2
11. C18:3
12. C20
13. C22
14. C22:1
15. C24

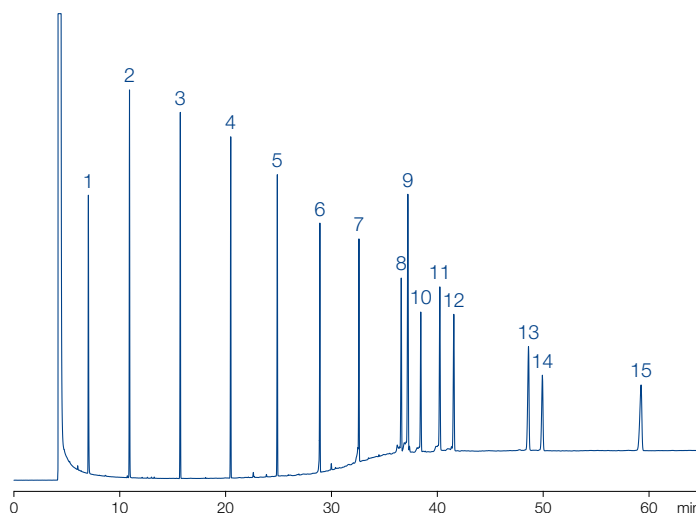

Ordering information

OPTIMA[®] FFAP

	Length →				
	10 m	25 m	30 m	50 m	60 m
0.1 mm ID (0.4 mm OD)					
0.10 µm film	726180.10				
0.25 mm ID (0.4 mm OD)					
0.25 µm film		726116.25	726116.30	726116.50	726116.60
0.32 mm ID (0.5 mm OD)					
0.25 µm film		726341.25	726341.30	726341.50	726341.60
0.50 µm film		726344.25	726344.30	726344.50	
0.53 mm ID (0.8 mm OD)					
0.50 µm film			726345.30		
1.00 µm film		726346.25			

In addition to this standard program we will be happy to supply columns custom-made to your specifications. Information about scope of delivery, special cages and integrated guard columns see additional information for GC columns on page 303.



OPTIMA[®] FFAPplus polyethylene glycol 2-nitroterephthalate · USP G35 / close equivalent to G25

★ Key features

- Polar phase
- Structure see page 309

✓ Recommended application

- FAMES, free carboxylic acids

✍ Temperature

- T_{max} 250 °C (long-term temperature),
T_{max} 260 °C (short-term max. temperature in a temperature program)

Similar phases

- DB-FFAP, HP-FFAP, CP-SIL 58 CB, 007-FFAP, CP-FFAP CB, Nukol™

FAMES from biodiesel

MN Appl. No. 214590

Column: OPTIMA[®] FFAPplus, 30 m x 0.25 mm ID, 0.25 µm film
 Injection: 1 µL, 260 °C, split 1:15
 Carrier gas: 40 cm/s He
 Temperature: 70 °C (1 min) → 240 °C, 30 °C/min (10 min)
 Detector: MS-EI, ion source 200 °C, interface temperature 250 °C

Peaks:

Methyl esters of:

1. Caproic acid (C6:0)
2. Caprylic acid (C8:0)
3. Capric acid (C10:0)
4. Lauric acid (C12:0)
5. Myristic acid (C14:0)
6. Palmitic acid (C16:0)
7. Palmitoleic acid (C16:1)
8. Stearic acid (C18:0)
9. Oleic acid (C18:1 *cis*)
10. Linoleic acid (C18:2 *cis*)
11. Nonadecanoic acid (C19:0)
12. Linolenic acid (C18:3)
13. Arachidic acid (C20:0)
14. Behenic acid (C22:0)
15. Erucic acid (C22:1 *cis*)
16. Lignoceric acid (C24:0)
17. Nervonic acid (C24:1 *cis*)

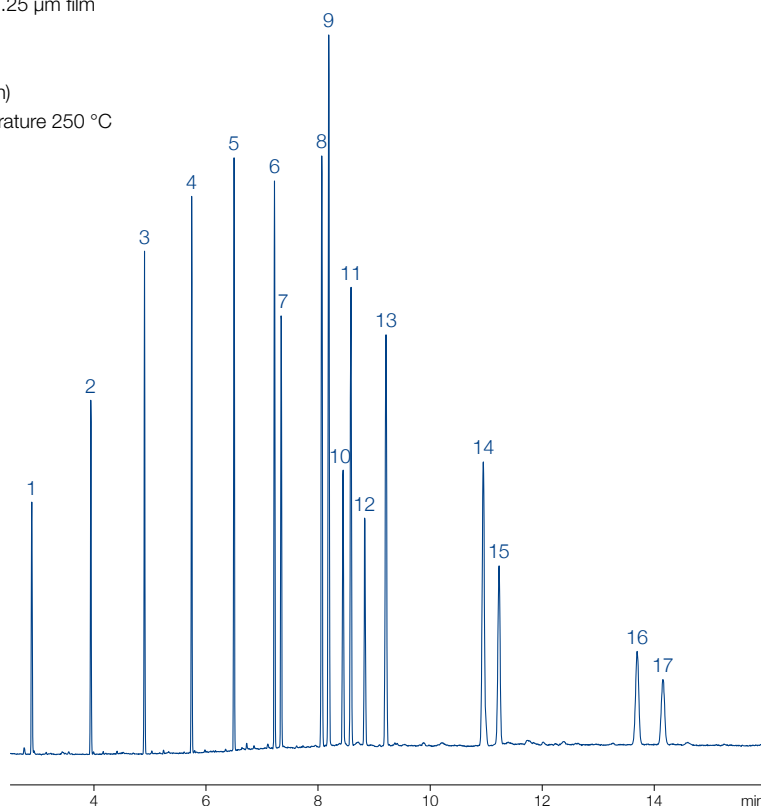

Ordering information

OPTIMA[®] FFAPplus

	Length →	
	30 m	60 m
0.25 mm ID (0.4 mm OD)		
0.25 µm film	726241.30	726241.60
0.50 µm film	726242.30	726242.60
0.32 mm ID (0.5 mm OD)		
0.25 µm film	726243.30	726243.60
0.50 µm film	726246.30	726246.60

In addition to this standard program we will be happy to supply columns custom-made to your specifications. Information about scope of delivery, special cages and integrated guard columns see additional information for GC columns on page 303.

Further applications can be found online in our application database at www.mn-net.com/apps



PERMABOND[®] SE-30 100 % dimethylpolysiloxane · USP G1 / G2 / G38

★ Key features

- Nonpolar phase

✎ Temperature

- T_{max} 300 °C (long-term temperature),
- T_{max} 320 °C (short-term max. temperature in a temperature program)

Similar phases

- OPTIMA[®] 1 (see page 310)

Ordering information

PERMABOND[®] SE-30

	Length → 25 m	50 m
0.25 mm ID (0.4 mm OD)		
0.25 µm film	723052.25	723052.50
0.32 mm ID (0.5 mm OD)		
0.25 µm film	723306.25	
0.50 µm film		723308.50

In addition to this standard program we will be happy to supply columns custom-made to your specifications. Information about scope of delivery, special cages and integrated guard columns see additional information for GC columns on page 303.

PERMABOND[®] SE-52 5 % phenyl – 95 % dimethylpolysiloxane · USP G27

★ Key features

- Nonpolar phase

✎ Temperature

- T_{max} 300 °C (long-term temperature),
- T_{max} 320 °C (short-term max. temperature in a temperature program)

Similar phases

- OPTIMA[®] 5 (see page 314)

Ordering information

PERMABOND[®] SE-52

	Length → 25 m
0.25 mm ID (0.4 mm OD)	
0.25 µm film	723054.25
0.32 mm ID (0.5 mm OD)	
0.25 µm film	723310.25
0.50 µm film	723312.25

In addition to this standard program we will be happy to supply columns custom-made to your specifications. Information about scope of delivery, special cages and integrated guard columns see additional information for GC columns on page 303.



PERMABOND[®] capillary columns



PERMABOND[®] CW 20 M polyethylene glycol 20 000 Dalton · USP G16

★ Key features

- Polar phase

✓ Recommended application

- Solvent analysis and alcohols, suitable for aqueous solutions

✍ Temperature

- 0.1–0.32 mm ID:
 T_{max} 220 °C (long-term temperature),
 T_{max} 240 °C (short-term max. temperature in a temperature program)
- 0.53 mm ID: T_{max} 200 and 220 °C, resp.

Similar phases

- See OPTIMA[®] WAX (see page 332)

Ordering information

PERMABOND[®] CW 20 M

	Length → 10 m	25 m	30 m	50 m	60 m
0.1 mm ID (0.4 mm OD)					
0.10 µm film	723064.10				
0.25 mm ID (0.4 mm OD)					
0.25 µm film	723060.10	723060.25	723060.30	723060.50	723060.60
0.32 mm ID (0.5 mm OD)					
0.25 µm film	723321.10	723321.25	723321.30	723321.50	723321.60
0.35 µm film	723827.10	723827.25		723827.50	
0.50 µm film	723296.10	723296.25	723296.30	723296.50	723296.60
0.53 mm ID (0.8 mm OD)					
0.50 µm film	723515.10	723515.25			
1.00 µm film	723549.10	723549.25	723549.30		
2.00 µm film	723517.10	723517.25	723517.30		

In addition to this standard program we will be happy to supply columns custom-made to your specifications. Information about scope of delivery, special cages and integrated guard columns see additional information for GC columns on page 303.

Further applications can be found online in our application database at www.mn-net.com/apps



PERMABOND[®] capillary columns



PERMABOND[®] FFAP polyethylene glycol 2-nitroterephthalate · USP G35 / close equivalent to G25

★ Key features

- Polar phase

✓ Recommended application

- FAMES, free carboxylic acids

✍ Temperature

- 0.1–0.32 mm ID:
 - T_{max} 220 °C (long-term temperature),
 - T_{max} 240 °C (short-term max. temperature in a temperature program)
- 0.53 mm ID: T_{max} 200 and 220 °C, resp.

Similar phases

- See OPTIMA[®] FFAP (see page 334)

Ordering information

PERMABOND[®] FFAP

	Length →					
	10 m	20 m	25 m	30 m	50 m	60 m
0.1 mm ID (0.4 mm OD)						
0.10 µm film	723180.10	723180.20				
0.25 µm film	723181.10					
0.25 mm ID (0.4 mm OD)						
0.10 µm film			723936.25		723936.50	
0.25 µm film	723116.10		723116.25	723116.30	723116.50	723116.60
0.32 mm ID (0.5 mm OD)						
0.10 µm film			723356.25		723356.50	
0.25 µm film			723341.25	723341.30	723341.50	723341.60
0.35 µm film	723830.10		723830.25		723830.50	
0.50 µm film	723344.10		723344.25	723344.30	723344.50	723344.60
0.53 mm ID (0.8 mm OD)						
1.00 µm film	723555.10		723555.25		723555.50	

In addition to this standard program we will be happy to supply columns custom-made to your specifications. Information about scope of delivery, special cages and integrated guard columns see additional information for GC columns on page 303.

Further applications can be found online in our application database at www.mn-net.com/apps



Capillary columns for special GC separations

Certain analytical separations can be accomplished more easily with chromatographic columns, that have been especially developed for that task, compared with standard columns. The

following table summarizes our program of GC speciality capillaries, the individual columns will be described in detail on the following pages.

Overview		
Separation/special application	Recommended capillary column	Page
Fast GC column with 0.10 mm ID	OPTIMA® 1, OPTIMA® 5, OPTIMA® δ-3, OPTIMA® δ-6 OPTIMA® 17, OPTIMA® 225, OPTIMA® FFAP PERMABOND® CW 20 M, PERMABOND® FFAP	340
Enantiomer separation cyclodextrin phases	FS-LIPODEX® A, FS-LIPODEX® B, FS-LIPODEX® C FS-LIPODEX® D, FS-LIPODEX® E, FS-LIPODEX® G	342
	FS-HYDRODEX β-PM, FS-HYDRODEX β-3 P, FS-HYDRODEX β-6TBDM, FS-HYDRODEX β-6TBDE, FS-HYDRODEX β-6TBDE, FS-HYDRODEX β-TBDAC, FS-HYDRODEX γ-DIMOM	344
Biodiesel		
Methanol analysis	OPTIMA® BioDiesel M	346
FAME analysis	OPTIMA® BioDiesel F	346
Glycerol and triglycerides	OPTIMA® BioDiesel G	346
Triglycerides		
	OPTIMA® 1-TG	348
	OPTIMA® 17-TG	348
High temperature GC		
	OPTIMA® 5 HT	349
Amines		
Polyfunctional amines	OPTIMA® 5 Amine	350
Amine separations	FS-CW 20 M-AM	351
Petrochemical products (complex hydrocarbon mixtures)		
	PERMABOND® P-100	352
Environmental analysis of volatile halogenated hydrocarbons		
	PERMABOND® SE-54 HKW	352
Silanes (monomeric, e.g., chlorosilanes)		
	PERMABOND® Silane	354
Diethylene glycol, e.g., for the quality control of wine		
	PERMABOND® CW 20 M-DEG	354

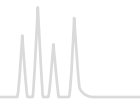

Fast GC

★ Key features

- Decreased column diameters, high heating rates and decreased column lengths for faster GC separations with high resolution efficiency
- Small inner diameters combined with very fast temperature programs can reduce the analysis time by up to 80 %
- High sensitivity detectors with small volume and very short response time, as well as very rapid data acquisition and processing
- Small inner diameters result in high column inlet pressures and a lower volume flow of the mobile phase: very fast injection of very small samples against a high pressure
- Amount of sample, which can be injected, is limited by the inner diameter and the thin film

✎ Temperature

- High heating rates place special demands on stationary phases. OPTIMA® columns meet exactly this requirement: very low bleeding, long lifetimes, even for continuous high heating rates

Comparison of a separation on a 50 m standard capillary with separation on a 10 m fast GC column
MN Appl. No. 211260

Peaks:

1. Octanol
2. Undecane
3. Dimethylaniline
4. Dodecane
5. Decylamine
6. Methyl decanoate
7. Methyl undecanoate
8. Henicosane
9. Docosane
10. Tricosane

A) Fast GC column

Column: OPTIMA® 5, 10 m x 0.1 mm ID,
0.1 µm film
Injection 1 µL, split 1:40,
Carrier gas 0.75 bar He

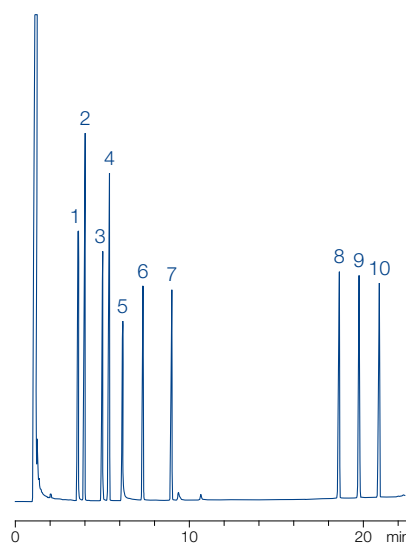

B) standard GC column

Column: OPTIMA® 5, 50 m x 0.25 mm ID,
0.25 µm film
Injection 1 µL, split 1:35,
Carrier gas 1.5 bar He

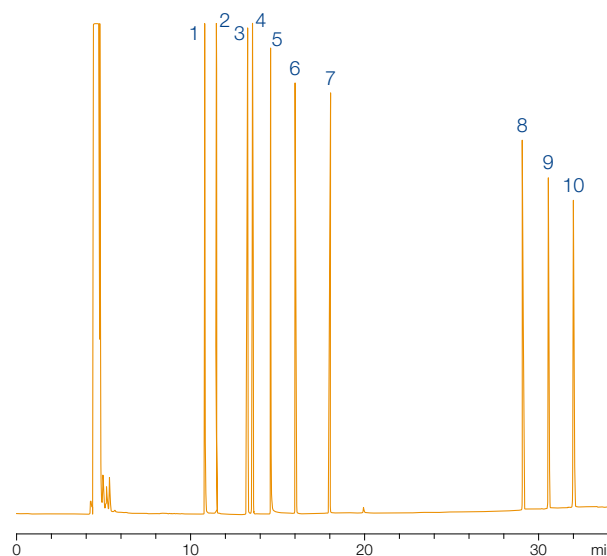

Both separations:

Temperature: 80 °C → 320 °C (10 min), 8 °C/min

Detector: FID

While maintaining the temperature program and halving the pressure a time saving of 30 % results with identical separation efficiency.



Capillary columns for Fast GC



Ordering information

Columns for Fast GC

Phase	Maximum temperature	ID [mm]	Film thickness [µm]	REF (10 m)	REF (20 m)
OPTIMA® 1	340/360 °C	0.10	0.10	726024.10	726024.20
		0.10	0.40		726025.20
OPTIMA® 5	340/360 °C	0.10	0.10	726846.10	
			0.10		
OPTIMA® δ-3	340/360 °C	0.10	0.10	726410.10	726410.20
OPTIMA® δ-6	340/360 °C	0.10	0.10	726490.10	
OPTIMA® 17	320/340 °C	0.10	0.10	726848.10	
OPTIMA® 225	260/280 °C	0.10	0.10	726080.10	
OPTIMA® FFAP	250/260 °C	0.10	0.10	726180.10	
PERMABOND® CW 20 M	220/240 °C	0.10	0.10	723064.10	
PERMABOND® FFAP	220/240 °C	0.10	0.10	723180.10	723180.20
		0.10	0.25	723181.10	
OPTIMA® 5 Amine	300/320 °C	0.10	0.40	726361.10	
FS-CW 20 M-AM	220/240 °C	0.10	0.25	733111.10	
FS-LIPODEX® E	200/220 °C	0.10	0.10	723382.10	
FS-HYDRODEX β-6TBDM	230/250 °C	0.10	0.10	723383.10	

In addition to this standard program, all MN GC phases can be custom-made as fast GC columns

Further applications can be found online in our application database at www.mn-net.com/apps



LIPODEX® cyclodextrin phases for enantiomer separation

★ Key features

- Base material: cyclic oligosaccharides consisting of six (α -cyclodextrin), seven (β -cyclodextrin) or eight (γ -cyclodextrin) glucose units bonded through 1,4-linkages
- Regioselective alkylation and / or acylation of the hydroxyl groups leads to lipophilic phases with varying enantioselectivity, which are well suited for GC enantiomer analysis
- Important advantage: many compounds can be analyzed without derivatization (however, for certain substances enantioselectivity can be favorably influenced by formation of derivatives)

✓ Recommended application

- A large number of separations have been achieved, however, it is not possible to make a general prediction, which phase could solve a given separation task. Even for compounds with small structural differences or within homologous series the enantiodifferentiation can be quite different. The following table shows typical applications.

Note:

- Water as solvent is strictly forbidden for all cyclodextrin phases
- Dry the sample with our CHROMAFIX® Dry (Na_2SO_4) cartridges (see page 61)
- Use suitable nonpolar solvent

Phase	Cyclodextrin derivate	T _{max} [°C]	Recommended application
LIPODEX® A	hexakis-(2,3,6-tri-O-pentyl)- α -CD	200 / 220	carbohydrates, polyols, diols, hydroxycarboxylic acid esters, (epoxy-) alcohols, glycerol derivatives, spiroacetals, ketones, alkyl halides
LIPODEX® B	hexakis-(2,6-di-O-pentyl-3-O-acetyl)- α -CD	200 / 220	lactones, diols (cyclic carbonates), aminols, aldols (O-TFA), glycerol derivatives (cyclic carbonates)
LIPODEX® C	heptakis-(2,3,6-tri-O-pentyl)- β -CD	200 / 220	Alcohols, cyanhydrins, olefins, hydroxycarboxylic acid esters, alkyl halides
LIPODEX® D	heptakis-(2,6-di-O-pentyl-3-O-acetyl)- β -CD	200 / 220	aminols (TFA), β -amino acid esters, trans-cycloalkane-1,2-diols, trans-cycloalkane-1,2-diols, trans-cycloalkane-1,3-diols (TFA)
LIPODEX® E	octakis-(2,6-di-O-pentyl-3-O-buteryl)- γ -CD	200 / 220	α -amino acids, α - and β -hydroxycarboxylic acid esters, alcohols (TFA), diols (TFA), ketones, pheromones (cyclic acetals), amines, alkyl halides, lactones
LIPODEX® G	octakis-(2,3-di-O-pentyl-6-O-methyl)- γ -CD	220 / 240	menthol isomers, ketones, alcohols, carboxylic acid esters, terpenes

Ordering information

LIPODEX®

	Length →	10 m	25 m	50 m
		0.10 mm ID	0.25 mm ID	0.25 mm ID
FS-LIPODEX® A			723360.25	723360.50
FS-LIPODEX® B			723362.25	723362.50
FS-LIPODEX® C			723364.25	723364.50
FS-LIPODEX® D			723366.25	723366.50
FS-LIPODEX® E		723382.10	723368.25	723368.50
FS-LIPODEX® G			723379.25	723379.50

All columns with 0.4 mm OD



Capillary columns for enantiomer separation



Enantiomer separation of amino acid methyl esters (TFA)

MN Appl. No. 202592

Column: FS-LIPODEX® E, 25 m x 0.25 mm ID
 Injection: 1 µL, split ~ 1: 100
 Carrier gas: 60 kPa H₂
 Temperature: 90 → 190 °C, 4 °C/min
 Detector: FID 250 °C

Peaks:

(D is eluted before L except for proline: L before D)

1. Alanine
2. Valine
3. Leucine
4. Proline
5. Aspartic acid
6. Phenylalanine

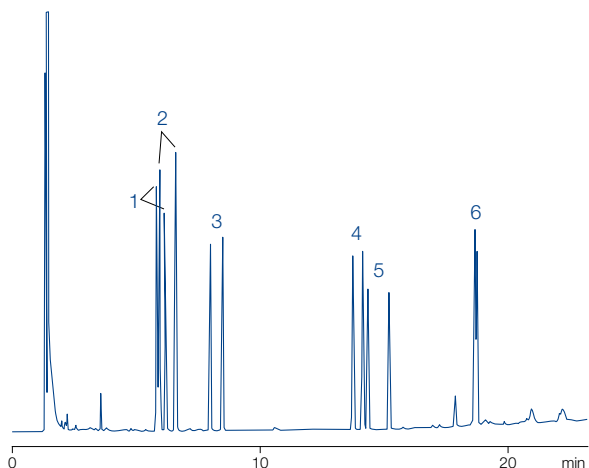

Separation of chiral constituents of peppermint oil

MN Appl. No. 250410

W. A. König et al., High Resol. Chromatogr. 20 (1997) 55–61
 Column: FS-LIPODEX® G, 25 m x 0.25 mm ID
 Carrier gas: 50 kPa H₂
 Temperature: 75 °C, isothermal
 Detector: FID

Peaks:

- | | |
|-------------------------------|-----------------------|
| 1. (+)-trans-Sabinene hydrate | 10. (+)-Neomenthol |
| 2. (+)-Menthone | 11. (-)-Neomenthol |
| 3. (+)-Isomenthone | 12. (+)-Neoisomenthol |
| 4. (-)-Menthone | 13. (+)-Menthol |
| 5. (-)-Isomenthone | 14. (-)-Neoisomenthol |
| 6. (+)-Menthofuran | 15. (+)-Piperitone |
| 7. (-)-Isopulegol | 16. (-)-Menthol |
| 8. (-)-Menthyl acetate | 17. (+)-Isomenthol |
| 9. (+)-Pulegone | 18. (-)-Isomenthol |

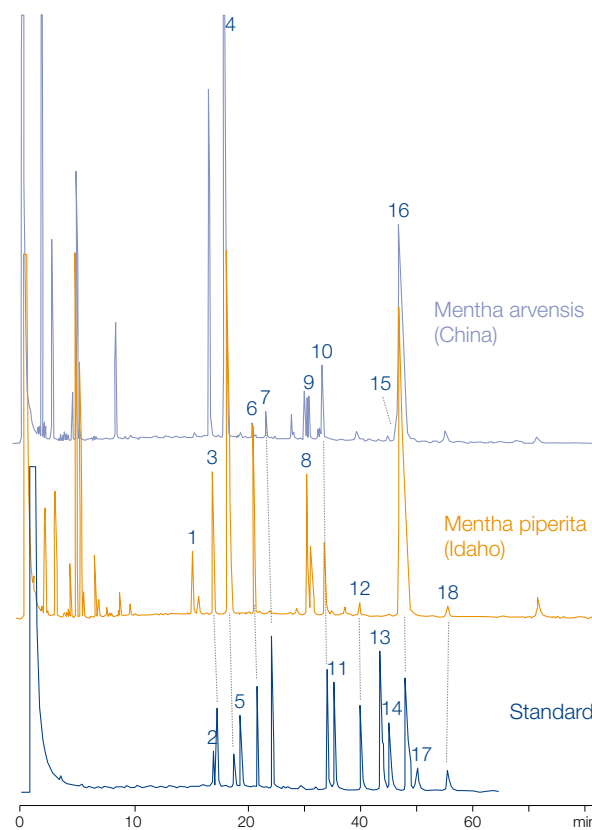

Cyclodextrin derivates

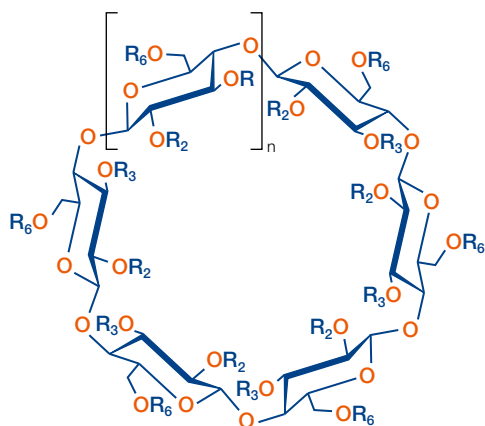

Further applications can be found online in our application database at www.mn-net.com/apps



HYDRODEX cyclodextrin phases for enantiomer separation

Recommended application

- Cyclodextrin derivatives (see page 343) with high melting point: for GC enantiomer separation diluted with polysiloxanes

Enantiomer separation of dichlorprop methyl ester

MN Appl. No. 202542

Column: FS-HYDRODEX β -3P, 25 m x 0.25 mm ID
 Injection: 0.1 μ L (~1 % in CH_2Cl_2), split 130 mL/min
 Carrier gas: 60 kPa H_2 (1.9 mL/min)
 Temperature: 160 $^\circ\text{C}$
 Detector: FID 250 $^\circ\text{C}$

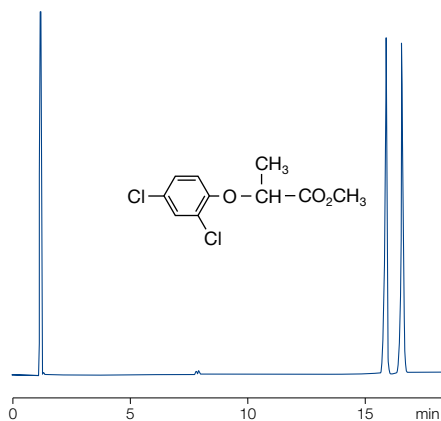
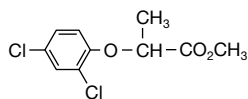

Separation of isomeric antiinflammatory drugs

MN Appl. No. 210150

Courtesy of Prof. W.A. König, Hamburg, Germany
 Column: FS-HYDRODEX β -6TBDM, 25 m x 0.25 mm ID
 Carrier gas: He
 Temperature: 135 $^\circ\text{C}$ \rightarrow 200 $^\circ\text{C}$, 1 $^\circ\text{C}/\text{min}$
 Detector: FID

Peaks:

1. Ibuprofen

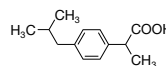

4. Naproxen

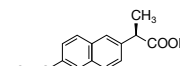

2. Flurbiprofen

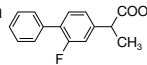

5. Ketoprofen

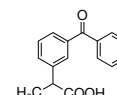

3. Fenoprofen

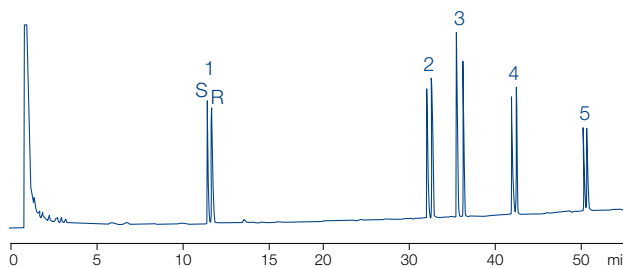
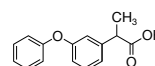

Phase	Cyclodextrin derivative (diluted with optimized polysiloxane)	T_{max} [$^\circ\text{C}$]	Recommended application
HYDRODEX β -PM	heptakis-(2,3,6-tri-O-methyl)- β -CD	230 / 250	hydroxycarboxylic acid esters, alcohols, diols, olefins, lactones, acetals
HYDRODEX β -3P	heptakis-(2,6-di-O-methyl-3-O-pentyl)- β -CD	230 / 250	terpenes, dienes, allenes, terpene alcohols, 1,2-epoxy-alkanes, carboxylic acids (esters), hydroxycarboxylic acid esters, pharmaceuticals, pesticides
HYDRODEX β -6TBDM	heptakis-(2,3-di-O-methyl-6-O-t-butyl-dimethyl-silyl)- β -CD	230 / 250	γ -lactones, cyclopentanones, terpenes, esters, tartrates
HYDRODEX β -6TBDE	heptakis-(2,3-di-O-ethyl-6-O-t-butyl-dimethyl-silyl)- β -CD	230 / 250	essential oils
HYDRODEX β -TBDAc	heptakis-(2,3-di-O-acetyl-6-O-t-butyl-dimethyl-silyl)- β -CD	220 / 240	alcohols, esters, ketones, aldehydes, δ -lactones
HYDRODEX γ -TBDAc	octakis-(2,3-di-O-acetyl-6-O-t-butyl-dimethyl-silyl)- γ -CD	220 / 240	cyclic ketones, aromatic ketones, oxiranes, aromatic esters, aromatic amides
HYDRODEX γ -DIMOM	octakis-(2,3-di-O-methoxymethyl-6-O-t-butyl-dimethyl-silyl)- γ -CD	220 / 240	ketones, terpenes, cyclic ethers, alcohols, amines



Capillary columns for enantiomer separation



Separation of (R/S) citronellol + citronellal

MN Appl. No. 212440

Column: FS-HYDRODEX β -TBDac, 50 m x 0.25 mm ID
 Injection: 1 μ L, 1:1000 in CH₂Cl₂, split 25 mL/min
 Carrier gas: 1.5 bar H₂
 Temperature: 100 °C
 Detector: FID 220 °C

Peaks:

1. (R)/(S)-Citronellal
2. (S)/(R)-Citronellal
3. (S)-Citronellol
4. (R)-Citronellol

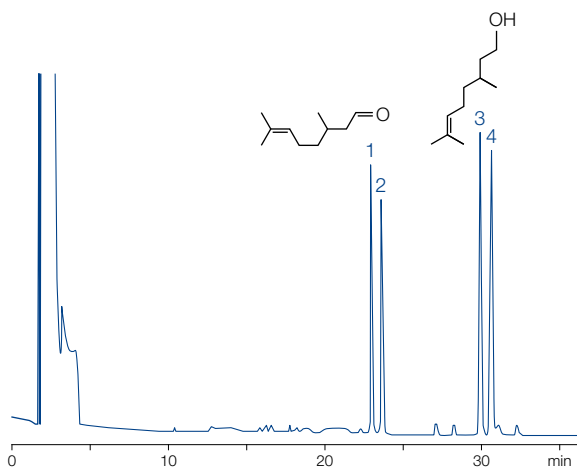

Separation of essential oils

MN Appl. No. 212980/212990/213000

Column: FS-HYDRODEX γ -TBDac, 50 m x 0.25 mm ID
 Injektor: 220 °C
 Carrier gas: 1.2 bar H₂
 Temperature: 125 °C
 Detector: FID 220 °C

Peaks:

1. Fenchone (1.5 mg/mL)
2. Menthone (0.5 mg/mL)
3. Menthol (2 mg/mL)

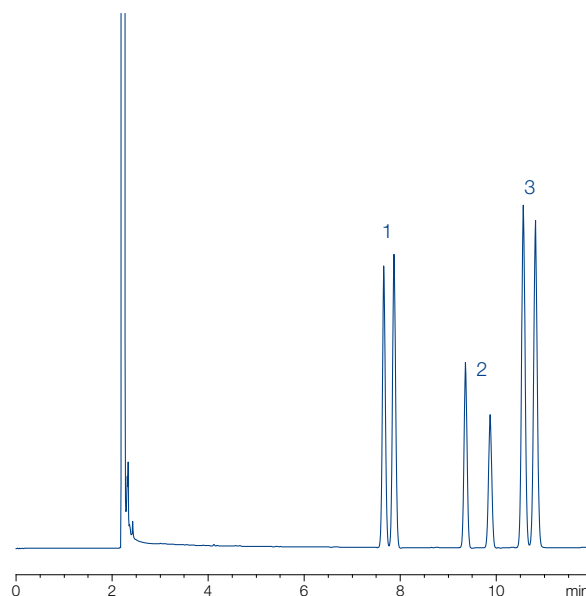

Ordering information

HYDRODEX

Length →	10 m 0.10 mm ID	25 m 0.25 mm ID	50 m 0.25 mm ID
FS-HYDRODEX β -PM		723370.25	723370.50
FS-HYDRODEX β -3P		723358.25	723358.50
FS-HYDRODEX β -6TBDM	723383.10	723381.25	723381.50
FS-HYDRODEX β -6TBDE		723386.25	
FS-HYDRODEX β -TBDac		723384.25	723384.50
FS-HYDRODEX γ -TBDac		723387.25	723387.50
FS-HYDRODEX γ -DIMOM		723388.25	723388.50
All columns with 0.4 mm OD			

Further applications can be found online in our application database at www.mn-net.com/apps



OPTIMA® BioDiesel for the analysis of biodiesel (DIN EN 14214 / ASTM D 6751)

OPTIMA® BioDiesel M for analysis of methanol in accordance with DIN EN 14110

★ Key features

- The methanol content in biodiesel as specified in DIN EN 14110 must not exceed 0.2 %. The column OPTIMA® BioDiesel M allows the GC headspace analysis of the methanol content in biodiesel in the concentration range from 0.01 to 0.5 % with 2-propanol as internal standard.

✍ Temperature

- T_{\max} 340 °C (long-term temperature),
 T_{\max} 360 °C (short-term max. temperature in a temperature program)

Similar phases

- Select™ Biodiesel for Methanol, Trace TR-BioDiesel (M)

OPTIMA® BioDiesel F for analysis of FAMES in accordance with DIN EN 14103:2011

★ Key features

- The analysis of biodiesel requires separation of typical FAMES between myristic acid (C_{14}) and nervonic acid ($C_{24:1}$) methyl esters. This analysis is possible on OPTIMA® BioDiesel F in only 22 min. Additionally, linolenic acid methyl ester can be determined due to the good resolution. The extended standard DIN EN 14103:2011 also covers smaller FAMES starting from C_6 (see application 214510 on opposite page). Change of the internal standard from C_{17} to C_{19} also allows the analysis of animal fats.

✍ Temperature

- T_{\max} 240 °C (long-term temperature),
 T_{\max} 250 °C (short-term max. temperature in a temperature program)

Similar phases

- Select™ Biodiesel for FAME, Trace TR-BioDiesel (F)

OPTIMA® BioDiesel G for analysis of glycerol and glycerides in accordance with DIN EN 14105

★ Key features

- The capillary column OPTIMA® BioDiesel G allows determination of free glycerol and residues of mono-, di- and triglycerides in FAMES intended as additives for mineral oils. The procedure can be applied for FAMES from rapeseed oil, sunflower oil and soy bean oil. Glycerol as well as mono- and diglycerides are derivatized to more volatile substances by addition of MSTFA in the presence of pyridine (see page 363).

✍ Temperature

- T_{\max} 380 °C (long-term temperature),
 T_{\max} 400 °C (short-term max. temperature in a temperature program)

Similar phases

- Select™ Biodiesel for Glycerides, Trace TR-BioDiesel (G), MET-Biodiesel



Capillary columns for biodiesel analysis



Analysis of FAMES from biodiesel in accordance with DIN EN 14103:2011

MN Appl. No. 214510

Column: OPTIMA® BioDiesel F, 30 m x 0.25 mm ID
 Sample: 50 µg/mL each in dichloromethane
 Injection: 10 µL, 250 °C, split 1:20
 Carrier gas: 1.2 bar He
 Temperature: 80 °C → 250 °C (8.5 min), 20 °C/min
 Detector: FID 260 °C

Peaks:

- | | |
|----------|---------------------|
| 1. C6:0 | 9. C18:1 |
| 2. C8:0 | 10. C18:2 |
| 3. C10:0 | 11. C19:0, int. st. |
| 4. C12:0 | 12. C18:3 |
| 5. C14:0 | 13. C20:0 |
| 6. C16:0 | 14. C22:0 |
| 7. C16:1 | 15. C22:1 |
| 8. C18:0 | 16. C24:0 |

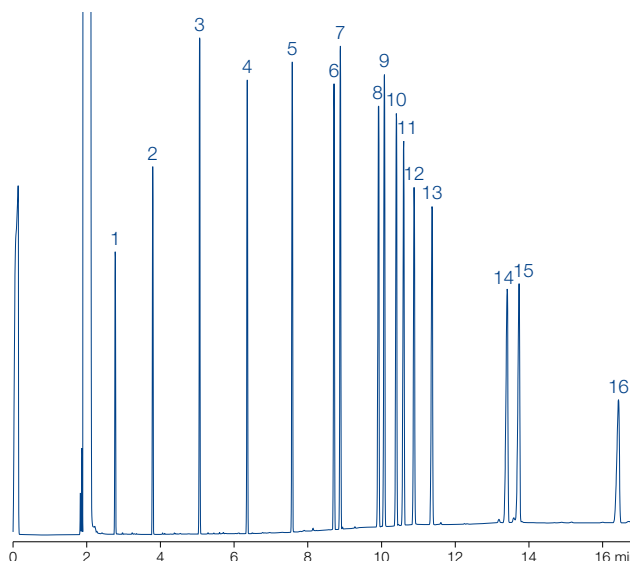

Analysis of glycerol and glycerides from biodiesel

MN Appl. No. 213640

Column: OPTIMA® BioDiesel G,
10 m x 0.25 mm ID
 Sample: A) standard in *n*-heptane
B) biodiesel
 Injection: 2 µL, 350 °C,
CIS (15 °C → 350 °C, 12 °C/s)
 Carrier gas: 0.8 bar H₂, split 1: 2.6
 Temperature: 50 °C (3.5 min) → 180 °C, 15 °C/min
→ 280 °C, 7 °C/min
→ 370 °C (10 min), 10 °C/min
 Detector: FID 380 °C

Peaks:

- Glycerol (TMS)
- Butanetriol (TMS), IS
- Monoolein = glycerol monooleate (TMS)
+ monoacylglycerides
- Tricaprin (glycerol tricaprinate), IS
- Diolein = glycerol dioleate (TMS)
+ diacylglycerides
- Triolein = glycerol trioleate
+ triacylglycerides

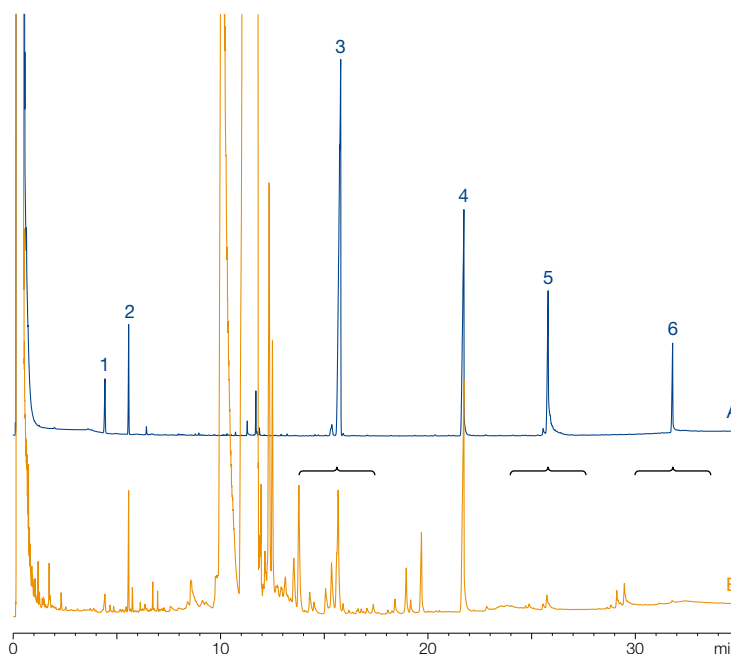

Ordering information

OPTIMA® BioDiesel

	Length → 10 m	30 m
OPTIMA® BioDiesel M		
0.32 mm ID (0.5 mm OD)		726905.30
OPTIMA® BioDiesel F		
0.25 mm ID (0.4 mm OD)		726900.30
OPTIMA® BioDiesel G		
0.25 mm ID (0.4 mm OD)	726903.10	



Capillary columns for triglyceride analysis



OPTIMA® 1-TG · 17-TG for triglyceride analysis · USP G1 / G2 / G38 (1-TG) · USP G3 (17-TG)

★ Key features

- Short capillary columns (max. 25 m and 0.32 mm ID) with low-bleeding stationary phases thermally stable with optimized deactivation

✓ Recommended application

- OPTIMA® 1-TG
100 % dimethylpolysiloxane offers separation according to carbon number
- OPTIMA® 17-TG
phenyl-methyl-polysiloxane (50 % phenyl) for separation according to degree of unsaturation

✍ Temperature

- T_{max} 370 °C (both phases)

Similar phases der OPTIMA® 1-TG:

- SPB-1 TG, DB-1 HT, 400-1 HT, HT-5

Triglycerides (from butter)

MN Appl. No. 201790

Column: OPTIMA® 1-TG, 25 m x 0.32 mm ID
 Injection: 0.5 µL
 Carrier gas: 80 kPa H₂
 Temperature: 80 °C (1 min) → 250 °C, 20 °C/min → 370 °C (10 min), 5 °C/min
 Detector: FID 380 °C

Peaks:

1. Cholesterol
2. T-30
3. T-34
4. T-38
5. T-42
6. T-46
7. T-50
8. T-54

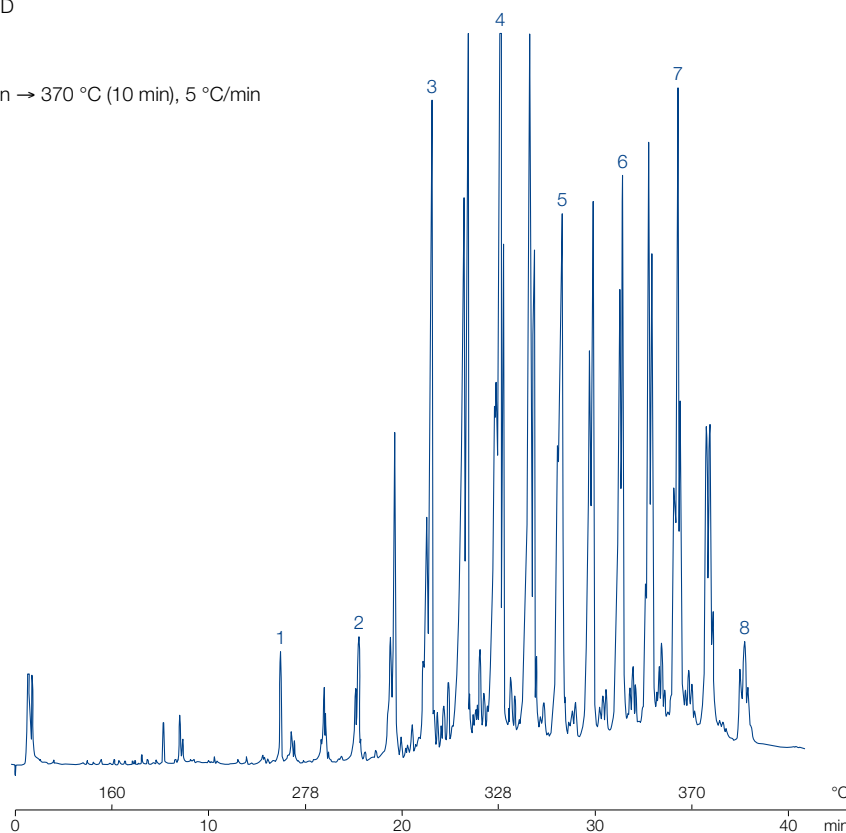

Ordering information

OPTIMA® 1-TG · OPTIMA® 17-TG

	Length →	
	10 m	25 m
OPTIMA® 1-TG		
0.25 mm ID (0.4 mm OD)	726133.10	726133.25
0.32 mm ID (0.5 mm OD)	726132.10	726132.25
OPTIMA® 17-TG		
0.32 mm ID (0.5 mm OD)	726131.10	726131.25



Capillary columns for high temperature GC



OPTIMA® 5 HT for high temperature GC · USP G27 / G36

★ Key features

- Chemically bonded, cross-linked silarylene phase with polarity similar to a 5 % diphenyl - 95 % dimethylpolysiloxane phase
- Nonpolar phase, low bleeding

Similar phases

- DB-5HT, VF-5HT, HT-5, XTI-5HT, ZB-5HT

✓ Recommended application

- Ideal for MS detectors, can be rinsed with solvents
- For simulated distillation, hydrocarbon, fuel and oil analysis, high-boiling analytes

✍ Temperature

- T_{max} 380 °C (long-term temperature), T_{max} 400 °C (short-term max. temperature in a temperature program)

Separation of motor oil / mineral oil (type A + B), rapid determination in accordance with DIN H-53 / ISO DIS

MN Appl. No. 213400

Column: OPTIMA® 5 HT, 15 m x 0.32 mm ID, 0.25 µm film
 Sample: mineral oil type A + B (hydrocarbon index kit acc. to EN ISO 9377-2) in hexane
 Injection: 1 µL, splitless, 300 °C
 Carrier gas: 0.6 bar He
 Temperature: 40 °C (5 min) → 390 °C, 50 °C/min
 Detector: FID 280 °C

Peaks:

1. Decane (C10)
2. Tetracontane (C40)

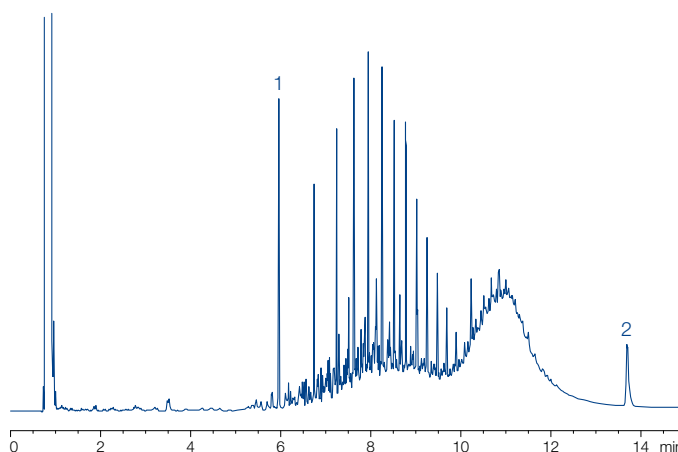

Ordering information

OPTIMA® 5 HT

	Length →	
	15 m	30 m
0.25 mm ID (0.4 mm OD)		
0.10 µm film	726102.15	726102.30
0.25 µm film	726106.15	726106.30
0.32 mm ID (0.5 mm OD)		
0.10 µm film	726104.15	726104.30
0.25 µm film	726108.15	726108.30

Further applications can be found online in our application database at www.mn-net.com/apps



Capillary columns for amine separation



OPTIMA® 5 Amine special column for analysis of amines · USP G27 / G36

★ Key features

- Nonpolar phase
- Improved linearity for analysis of active components at trace levels: no amine absorptions even for aliphatic and aromatic amines at concentrations of 100 pg/peak
- Tested with the OPTIMA® Amine test mixture (REF 722317), which contains, amongst others, diethanolamine and propanol-pyridine (this test mixture is supplied with each column)

✓ Recommended application

- Especially deactivated for the analysis of polyfunctional amines such as ethanalamines, amino-functionalized diols and similar compounds, which are important base materials in industrial chemistry, and show strong tailing on standard-deactivated columns

✍ Temperature

- T_{max} 300 °C (long-term temperature), T_{max} 320 °C (short-term max. temperature in a temperature program)

Similar phases

- Rtx®-5 Amine, PTA-5

Separation of secondary and tertiary amines MN Appl. No. 210280

Column: OPTIMA® 5 Amine, 30 m x 0.25 mm ID, 1.0 µm film
 Injection: 1 µL, split 1:100
 Carrier gas: 0.6 bar H₂
 Temperature: 100 °C (3 min) → 280 °C, 10 °C/min
 Detector: FID 280 °C

Peaks:

- | | |
|-------------------------------|-------------------------------|
| 1. Diethylamine | 7. Di-isobutylamine |
| 2. Di-isopropylamine | 8. Tri- <i>n</i> -butylamine |
| 3. Triethylamine | 9. Di-isohexylamine |
| 4. Di- <i>n</i> -propylamine | 10. Dicyclohexylamine |
| 5. Di- <i>n</i> -butylamine | 11. Dibenzylamine |
| 6. Tri- <i>n</i> -propylamine | 12. Tri- <i>n</i> -hexylamine |

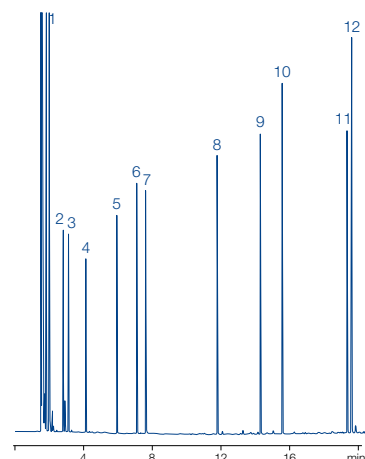

Ordering information

OPTIMA® 5 Amine

	Length → 10 m	25 m	30 m
0.1 mm ID (0.4 mm OD)			
0.40 µm film	726361.10		
0.2 mm ID (0.4 mm OD)			
0.35 µm film		726355.25	
0.25 mm ID (0.4 mm OD)			
0.50 µm film			726354.30
1.00 µm film			726358.30
0.32 mm ID (0.5 mm OD)			
0.25 µm film			726360.30
1.00 µm film			726353.30
1.50 µm film			726356.30
0.53 mm ID (0.8 mm OD)			
1.00 µm film			726359.30
3.00 µm film			726357.30



Capillary columns for amine separation



FS-CW 20 M-AM polyethylene glycol 20 000, non-immobilized · USP G16

★ Key features

- Polyethylene glycol, basic for amine separations

✎ Temperature

- T_{\max} 220 °C (long-term temperature),
- T_{\max} 240 °C (short-term max. temperature in a temperature program)

Similar phases

- Carbowax™ Amine, CP-Wax 51, CAM, Stabilwax® DB

Ordering information

FS-CW 20 M-AM

	Length → 10 m	25 m	50 m
0.1 mm ID (0.4 mm OD)			
0.25 µm film	733111.10		
0.25 mm ID (0.4 mm OD)			
0.25 µm film		733110.25	733110.50
0.32 mm ID (0.5 mm OD)			
0.25 µm film		733299.25	733299.50
0.35 µm film			733442.50
0.53 mm ID (0.8 mm OD)			
1.00 µm film		733551.25	

Further applications can be found online in our application database at www.mn-net.com/apps



MACHEREY-NAGEL CHROMAFIL® syringe filters

Ideal for the filtration of GC, HPLC and UHPLC sample solutions

- Diverse membrane types and filter sizes for a variety of applications
- Optimal flow geometry because of star-shaped distribution device
- Lowest content of extractable substances
- Luer lock inlet, Luer outlet
- Prefiltration of solvents protects sensitive instrument parts and chromatography columns from solid contamination and increases their lifetime.

Find CHROMAFIL® products from page 81 onwards.





Capillary columns for hydrocarbons

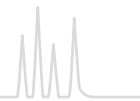

PERMABOND® P-100 for analysis of petrochemical products · USP G1 / G2 / G38

★ Key features

- Extra long column with nonpolar dimethylpolysiloxane phase

✓ Recommended application

- High resolution and sufficient capacity for analysis of complex mixtures of hydrocarbons

✍ Temperature

- T_{\max} 300 °C (long-term temperature),
 T_{\max} 320 °C (short-term max. temperature in a temperature program)

Ordering information

PERMABOND® P-100

	Length → 100 m
0.25 mm ID (0.4 mm OD)	
0.50 µm film	723890.100

PERMABOND® SE-54-HKW for volatile halogenated hydrocarbons · USP G36

✓ Recommended application

- SE-54 optimized for volatile halogenated hydrocarbons

✍ Temperature

- T_{\max} 300 °C (long-term temperature),
 T_{\max} 320 °C (short-term max. temperature in a temperature program)

For the analysis of halogenated hydrocarbons, we recommend our optimized column PERMABOND® SE-54-HKW at 25 or 50 m length with our approved polysiloxane phase SE-54.

As an alternative, or to verify analytical results, the OPTIMA® 624 has proven itself as advantageous, especially for the determination of 1,1,2-trichlorotrifluoroethane (F 113) along with dichloromethane.

Both phases are also suited for the determination of vinyl chloride as well as for the separation of cis/trans isomers of 1,2-dichloroethene. The high film thickness secures a high capacity and an outstanding resolution. For GC/MS coupling, we recommend OPTIMA® 624 LB or OPTIMA® 624 with 0.2 or 0.25 mm ID

Volatile halogenated hydrocarbons

MN Appl. No. 212480

Column: PERMABOND® SE-54-HKW, 50 m x 0.32 mm ID
Injection: 1 µL, split ~ 1:30
Carrier gas: 0.9 bar He
Temperature: 35 °C (25 min) → 160 °C (5 min), 10 °C/min
Detector: ECD 300 °C

Peaks:

1. Dichloromethane (795 ng/mL)
2. Trichloromethane (75 ng/mL)
3. 1,1,1-Trichloroethane (67 ng/mL)
4. 1,2-Dichloroethane (100 ng/mL)
5. Tetrachloromethane (15.9 ng/mL)
6. Trichloroethene (14.6 ng/mL)
7. Bromodichloromethane (20 ng/mL)
8. Dibromochloromethane (122 ng/mL)
9. Tetrachloroethene (81 ng/mL)
10. Tribromomethane (28.9 ng/mL)

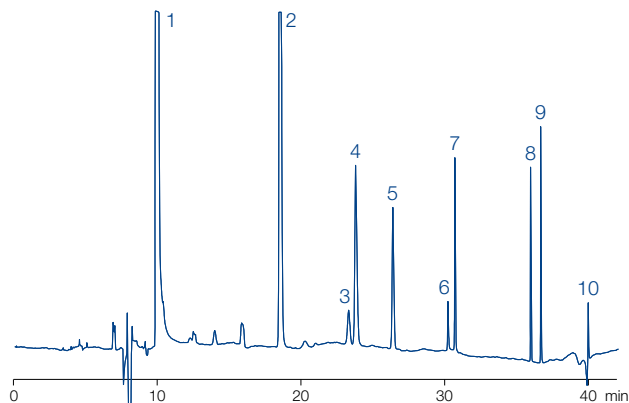



Capillary columns for hydrocarbons



Volatile halogenated hydrocarbons and BTX

MN Appl. No. 200160

Column: OPTIMA® 624, 50 m x 0.25 mm ID, 1.40 µm film
 Injection: 1 µL, split 50 mL/min
 Carrier gas: 0.9 mL/min He (constant flow)
 Temperature: 40 °C (5 min) → 160 °C, 10 °C/min
 Detector: MSD 5971

Peaks:

- | | |
|---|-----------------------------------|
| 1. Vinyl chloride | 12. 1,2-Dichloroethane + benzene |
| 2. Trichlorofluoromethane (F 11) | 13. Trichloroethene |
| 3. Pentane | 14. Bromodichloromethane |
| 4. 1,1,2-Trichlorotrifluoroethane (F 113) | 15. Toluene |
| 5. Dichloromethane | 16. Tetrachloroethene |
| 6. <i>trans</i> -1,2-Dichloroethene | 17. Dibromochloromethane |
| 7. Hexane | 18. Chlorobenzene |
| 8. <i>cis</i> -1,2-Dichloroethene | 19. Ethylbenzene |
| 9. Trichloromethane | 20. <i>m</i> - + <i>p</i> -Xylene |
| 10. 1,1,1-Trichloroethane | 21. <i>o</i> -Xylene |
| 11. Tetrachloromethane | 22. Tribromomethane |
| | 23. Bromobenzene |

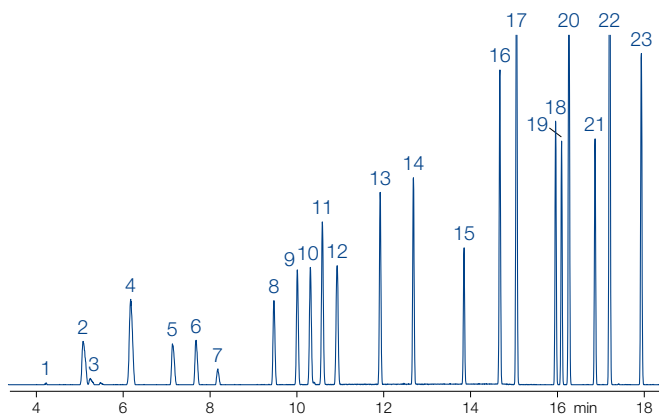

Ordering information

PERMABOND® SE-54-HKW

	Length →	
	25 m	50 m
0.32 mm ID (0.5 mm OD)		
1.80 µm film	723945.25	723945.50

Further applications can be found online in our application database at www.mn-net.com/apps



PERMABOND® Silane for silane analysis

✓ Recommended application

- Developed especially for the analysis of monomeric silanes and chlorosilanes (not for the separation of trimethylsilyl derivatives)
- Also suited for the separation of dimeric siloxanes and silazanes

✍ Temperature

- 0.32 mm ID: T_{max} 260 °C (long-term temperature), T_{max} 280 °C (short-term max. temperature in a temperature program)
- 0.53 mm ID: T_{max} 240 and 260 °C, resp.

Ordering information

PERMABOND® Silane

	Length → 25 m	50 m
0.32 mm ID (0.5 mm OD)		723409.50
0.53 mm ID (0.8 mm OD)	723411.25	

Chloromethylsilanes

MN Appl. No. 200090

Column: PERMABOND® Silane, 50 m x 0.32 mm ID
 Injection: 0.5 µL gas, split 80 mL/min
 Carrier gas: 1 mL/min He (constant flow)
 Temperature: 50 °C → 100 °C, 5 °C/min
 Detector: MSD 5971

Peaks:

1. Tetramethylsilane
2. Dichloromethane
3. Tetrachlorosilane
4. Chlorotrimethylsilane
5. Methyltrichlorosilane
6. Dichlorodimethylsilane
7. Hexamethyldisiloxane

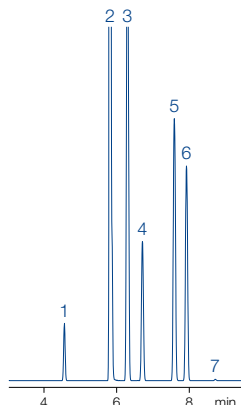

Diethylene glycol standard in wine

MN Appl. No. 201500

Column: PERMABOND® CW 20 M-DEG,
 25 m x 0.25 mm ID
 Injection: 0.5 µL, split ~1:40
 Carrier gas: 1.2 bar N₂
 Temperature: 80 °C → 200 °C, 10 °C/min
 Detector: FID 260 °C

Peaks:

- DEG standard
1. 1,4-Butanediol
 2. Diethylene glycol
 3. Glycerol

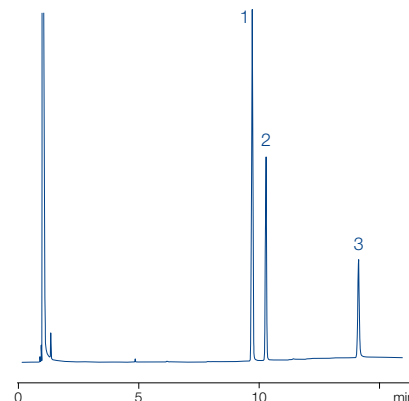

PERMABOND® CW 20 M-DEG for determination of diethylene glycol · USP G16

★ Key features

- Polyethylene glycol 20 000 (diethylene glycol tested)

✓ Recommended application

- Determination of diethylene glycol (DEG), e.g., for the quality control of wine

✍ Temperature

- T_{max} 220 °C (long-term temperature), T_{max} 240 °C (short-term max. temperature in a temperature program)

Ordering information

PERMABOND® CW 20 M-DEG

	Length → 25 m
0.25 mm ID (0.4 mm OD)	
0.25 µm film	723063.25
0.32 mm ID (0.5 mm OD)	
0.25 µm film	723327.25

Further applications can be found online in our application database at www.mn-net.com/apps



Untreated capillaries

✓ Recommended application

- Capillary electrophoresis
- Preparation of capillary columns
- Capillary LC applications

Ordering information

Untreated capillaries

	Length → 1 m Pack of 3	10 m Pack of 1	25 m Pack of 1
Capillaries for electrophoresis			
0.025 mm ID (0.4 mm OD)	723793.1	723793.2	
0.05 mm ID (0.4 mm OD)	723790.1	723790.2	
0.075 mm ID (0.4 mm OD)	723791.1	723791.2	
0.10 mm ID (0.4 mm OD)	723792.1	723792.2	
Untreated capillaries			
0.20 mm ID (0.4 mm OD)		723148.10	723148.25
0.25 mm ID (0.4 mm OD)		723101.10	723101.25
0.32 mm ID (0.5 mm OD)		723151.10	723151.25
0.53 mm ID (0.8 mm OD)		723501.10	723501.25

Untreated capillaries are supplied without cage.

Deactivated capillary columns precolumns / guard columns

✓ Recommended application

- As precolumns / guard columns, whenever a larger contamination capacity is required
- Preparation of capillary columns

Ordering information

Deactivated capillary columns

	Length →	
	10 m	25 m
Methyl-Sil deactivated (T_{max} 320 °C)		
0.25 mm ID (0.4 mm OD)	723106.10	723106.25
0.32 mm ID (0.5 mm OD)	723346.10	723346.25
0.53 mm ID (0.8 mm OD)	723558.10	723558.25
Phenyl-Sil deactivated (T_{max} 320 °C)		
0.25 mm ID (0.4 mm OD)	723108.10	723108.25
0.32 mm ID (0.5 mm OD)	723348.10	723348.25
0.53 mm ID (0.8 mm OD)	723560.10	723560.25
CW deactivated (T_{max} 250 °C)		
0.25 mm ID (0.4 mm OD)	723105.10	723105.25
0.32 mm ID (0.5 mm OD)	723349.10	723349.25
0.53 mm ID (0.8 mm OD)	723562.10	723562.25

Untreated capillaries are supplied without cage.

For a considerably longer lifetime, even for contaminated or matrix-containing samples, MN offers the option of integrated precolumns. All capillary columns are available with a 10 m guard column with matched deactivation. For ordering, please add V1 at the end of the REF number. Guard column combinations with other lengths, IDs or different deactivation are available on request.

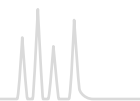

Retention gaps

★ Key features

- The retention gap technique in combination with on-column injection allows to concentrate a large sample volume in the capillary column.
- Choice of the retention gap depends on the solvent used: the flooded zone after injection should be between 20–30 cm/μL
- Me-Sil retention gap: only for use with *n*-hexane and diethyl ether
- Phe-Sil retention gap: for all solvents except methanol and water
- CW retention gap: for all solvents and especially for methanol and water

✎ Temperature

- T_{max} 250 °C (CW retention gaps),
- T_{max} 320 °C (Me-Sil and Phe-Sil retention gaps)

Note:

- Calculation example: length of flooded zone ~ 20–30 cm/μL, retention gap 10 m x 0.32 mm ID, capillary column: 25 m x 0.32 mm ID, max. injection volume ~ 30–50 μL
- A retention gap must be inert without any noticeable retention: Me-Sil retention gaps are more inert than Phe-Sil, while Phe-Sil is less susceptible to contamination
- Retention gaps can also be used as transfer lines or precolumns (contamination capacity about 5–10 μg).

Ordering information

Retention gaps

	Length →	
	10 m	25 m
Me-Sil retention gaps (T _{max} 320 °C)		
0.25 mm ID (0.4 mm OD)	723706.10	723706.25
0.32 mm ID (0.5 mm OD)	723707.10	723707.25
0.53 mm ID (0.8 mm OD)	723708.10	723708.25
Phe-Sil retention gaps (T _{max} 320 °C)		
0.25 mm ID (0.4 mm OD)	723709.10	723709.25
0.32 mm ID (0.5 mm OD)	723710.10	723710.25
0.53 mm ID (0.8 mm OD)	723711.10	723711.25
CW retention gaps (T _{max} 250 °C)		
0.25 mm ID (0.4 mm OD)	723712.10	723712.25
0.32 mm ID (0.5 mm OD)	723713.10	723713.25
0.53 mm ID (0.8 mm OD)	723714.10	723714.25

Retention gaps are supplied without cage.

For a considerably longer lifetime, even for contaminated or matrix-containing samples, MN offers the option of integrated precolumns. All capillary columns are available with a 10 m guard column with matched deactivation. For ordering, please add V1 at the end of the REF number. Guard column combinations with other lengths, IDs or different deactivation are available on request.



Derivatization reagents

★ Key features

- Derivatization reagents:
To improve volatility, increase thermal stability or to achieve a lower limit of detection in gas chromatography
- Prerequisite: quantitative, rapid and reproducible formation of only one derivative
- Halogen atoms inserted by derivatization, e.g., trifluoroacetates, allow the specific detection in an ECD with the advantage of high sensitivity.
- Specific derivatizations may influence elution orders and fragmentation patterns in a MS
- We provide reagents for
 - acylation
 - alkylation (methylation)
 - silylation
- For 1 x 10 mL, 1 x 50 mL and 6 x 50 mL also available with screw closure

Ordering information

Derivatization method development kits*

Designation	Contents of the kit	REF
Which type of derivatization is suited best for your sample (alkylation, acylation or silylation)?	2 x 1 mL each of TMSH, MSTFA, MBTFA	701952
Acylation kit		
Which is the proper reagent for acylation?	2 x 1 mL each of MBTFA, TFAA, MBHFBA	701950
Alkylation kit		
Which is the proper reagent for methylation?	3 x 1 mL each of TMSH, DMF-DMA	701951
Silylation kit		
Which is the proper reagent for silylation?	2 x 1 mL each of MSTFA, BSTFA, TSIM, MSHFBA	701953

* These products contain harmful substances which must be specially labeled as hazardous. For detailed information please see SDS.

Selection guide for derivatization of important functional groups in GC

Function	Method	Derivative	Recommended reagents
alcohols, phenols R'OH	silylation	R'O-TMS	BSA, MSTFA, MSHFBA, TSIM, SILYL-2110, SILYL-21, SILYL-1139
	acylation	R'O-CO-R	TFAA, HFBA, MBTFA, MBHFBA
	alkylation	R'O-R	TMSH
sterically hindered	silylation	R'O-TMS	TSIM, BSTFA, SILYL-991
amines primary, secondary	silylation	R'-NR''-TMS	BSA, MSTFA, MSHFBA, SILYL-991
	acylation	R'-NR''-CO-R	TFAA, HFBA, MBTFA, MBHFBA
hydrochlorides	silylation	R'-NR''-TMS	MSTFA
amides	silylation	not stable	
	acylation	R'-CO-NH-CO-R	TFAA, MBTFA, HFBA, MBHFBA
amino acids	silylation	R'-CH(NH-TMS)-CO-O-TMS	BSA, BSTFA, MSTFA, MSHFBA
	alkylation (a)	R'-CH(NH-CO-R)-CO-O-R	a) MeOH/TMCS, TMSH
	+ acylation (b)		b) TFAA, HFBA, MBTFA, MBHFBA
Carboxylic acids (fatty acids)	silylation	R'-CO-O-TMS susceptible to hydrolysis	BSA, MSTFA, MSHFBA, TMCS, TSIM, SILYL-2110, SILYL-21, Silyl-1139
	alkylation	R'-CO-O-R	DMF-DMA, MeOH/TMCS (1 M), TMSH
salts	silylation	R'-CO-O-TMS susceptible to hydrolysis	TMCS
carbohydrates	silylation		MSTFA, TSIM, HMDS, SILYL-1139
	acylation		TFAA, MBTFA
steroids	silylation		BSA, TSIM
	acylation		TFAA, MBTFA, HFBA, MBHFBA

These products contain harmful substances which must be specially labeled as hazardous. For detailed information please see SDS.

Due to their purpose, derivatization reagents are very reactive substances. For this reason, they should be stored cool and protected from moisture. For easy access with a syringe, our derivatization reagents are supplied in vials with crimp caps (exception DMCS and TMCS with screw closure). Vials with pierced sealing disks have limited stability and should be used soon.

The derivatization procedures can be found on page 367.



General reaction mechanisms

Silylation

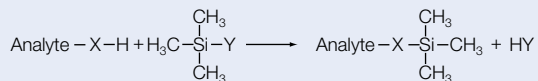

X = e.g., O, S, COO, etc.

Y = rest of silylation reagents

Acylation



X = e.g., O, S, NH, etc.

Y = rest of acylation reagents

Alkylation (Methylation) · example TMSH

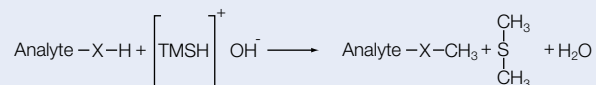

X = e.g., O, S, COO, etc.



MACHEREY-NAGEL

derivatization reagents for GC

Content of brochure

- Product range for acylation, alkylation and silylation reagents
- Protocols for derivatization
- Diverse tips and hints

Order now your derivatization brochure KATEN200144

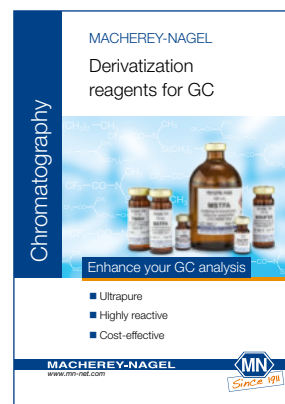



Acylation reagents

Acyl halides

★ Key features

- By-product of acylation with acyl halides: corresponding hydrohalic acids excess of reagent and acid have to be removed or trapped by a suitable base (e.g., pyridine)
- Pentafluorobenzoyl chloride
PFBC: $C_6F_5-CO-Cl$
M 230.52 g/mol, Bp 158–159 °C (760 mm Hg),
Density $d_{20^{\circ}/4^{\circ}} = 1.601$

Anhydrides

★ Key features

- By-products of acylation with anhydrides: corresponding acids excess reagent and the acid formed are to be removed
- Trifluoroacetic acid anhydride TFAA: $CF_3-CO-O-CO-CF_3$
M 210.04 g/mol, Bp 39.5–40.5 °C (760 mm Hg),
Density $d_{20^{\circ}/4^{\circ}} = 1.490$
- Heptafluorobutyric acid anhydride
HFBA: $C_3F_7-CO-O-CO-C_3F_7$
M 410.06 g/mol, Bp 106–107 °C (760 mm Hg),
Density $d_{20^{\circ}/4^{\circ}} = 1.665$

Bisacylamides

★ Key features

- By-products: corresponding neutral acylamides: high volatility
- Easily removed; due to the neutral conditions and their favorable chromatographic characteristics, the removal of surplus bisacylamides and their by-products is often not necessary. Therefore, the sample preparation is much easier.
- *N*-methyl-bis(trifluoroacetamide)
MBTFA: $CF_3-CO-N(CH_3)-CO-CF_3$
M 223.08 g/mol, Kp 123–124 °C (760 mm Hg),
Density $d_{20^{\circ}/4^{\circ}} = 1.55$
- *N*-methyl-bis(heptafluorobutyramide)
MBHFBA: $C_3F_7-CO-N(CH_3)-CO-C_3F_7$
M 423.1 g/mol, Kp 165–166 °C (760 mm Hg),
Density $d_{20^{\circ}/4^{\circ}} = 1.673$



Methods for acylation

Acylation with fluorinated acid anhydrides (TFAA, HFBA)

- Applicable for alcohols, phenols, carboxylic acids, amines, amino acids and steroids, stable derivatives for FID or ECD detection
- Procedure see page 367 or online at www.mn-net.com/apps
TFAA: MN Appl. Nr. 213041
HFBA: MN Appl. Nr. 213042

Acylation with fluorinated acid amides (MBTFA, MBHFBA)

- Recommended for alcohols, primary and secondary amines as well as for thiols under mild, neutral conditions
- MBTFA also forms very volatile derivatives with carbohydrates [17].
- Procedure see page 367 or online at www.mn-net.com/apps
MBTFA: MN Appl. Nr. 213051
MBHFBA: MN Appl. Nr. 21305

Ordering information

Acylation reagents*

Substance	Packing unit			
	10 x 1 mL	20 x 1 mL	1 x 10 mL	5 x 10 mL
HFBA		701110.201	701110.110	701110.510
MBTFA		701410.201	701410.110	701410.510
MBHFBA	701420.101	701420.201		
PFBC	701120.101			
TFAA			701130.110	701130.510

* These products contain harmful substances which must be specially labeled as hazardous. For detailed information please see SDS.

On request for 1 x 10 mL, 1 x 50 mL and 6 x 50 mL also available with screw closure.



Alkylation / methylation reagents

DMF-DMA *N,N*-dimethylformamide dimethylacetal

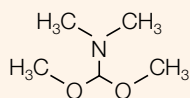

- M 119.17 g/mol,
Kp 106–107 °C (760 mm Hg),
Density d₂₀⁴ = 0.897

★ Key features

- Methylation reagents

TMSH (0.2 mol/L in methanol) Trimethylsulfonium hydroxide

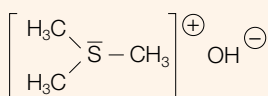

- M 94.06 g/mol

★ Key features

- Methylation reagents

Methods for alkylation / methylation

Methylation with TMSH

- Suited for free acids, chlorophenoxy-carboxylic acids, their salts and derivatives as well as for phenols and chlorophenols [18]
- The great advantage is the simplification of the sample preparation. Lipids or triglycerides can be converted to the corresponding fatty acid methyl esters (FAMES) by simple transesterification.
- This reaction is very elegant and convenient, because it is only necessary to add the reagent (0.2 mol/L in methanol) to the sample solution. Removal of surplus reagent is not required, since at 250 °C inside the injector of the gas chromatograph, TMSH will pyrolyze solely to volatile methanol and dimethylsulfide. Due to high reactivity, a complete conversion is usually obtained at ambient temperature. Heating (e.g., 10 min at 100 °C) in a closed sample vial may be necessary, however.
- Procedure see page 367 or online at www.mn-net.com/apps
MN Appl. Nr. 213060

Methylation with DMF-DMA

- Applicable for fatty acids, primary amines and (partially) amino acids, under formation of *N*-dimethyl-aminomethylene amino acid methyl esters [19]
- Since DMF-DMA is a poor solvent, it is essential to use a mixture of DMF-DMA with pyridine, THF, acetone (barbiturates) or another solvent.
- Procedure see page 367 or online at www.mn-net.com/apps
MN Appl. Nr. 213070

Methylation with methanol – TMCS (1 M)

- Suited for the esterification of free carboxylic acids and the transesterification of glycerides. Formation of HCl catalyzes the reaction. TMCS, resp. silyl ethers remove the water and thus drive the reaction to completion. The mixture should be freshly prepared.
- Procedure see page 367 or online at www.mn-net.com/apps
MN Appl. Nr. 213080

For GC separation of FAMES from natural butter fat after derivatization with TMSH see Appl. 201680 at www.mn-net.com/apps

Ordering information

Alkylation reagents*

Substance	Packing unit			
	10 x 1 mL	20 x 1 mL	1 x 10 mL	5 x 10 mL
DMF-DMA		701430.201	701430.110	
TMSH	701520.101	701520.201	701520.110	701520.510

* These products contain harmful substances which must be specially labeled as hazardous. For detailed information please see SDS.

On request for 1 x 10 mL, 1 x 50 mL and 6 x 50 mL also available with screw closure.



Silylation reagents

The most common form of silylation in GC is the replacing of active hydrogen atoms with a trimethylsilyl group (TMS derivative). Less frequently, trialkylsilyl groups or dimethylsilyl groups with longer alkyl chains are also in use. The alkylsilyl group increases volatility and enhances thermal stability of the sample.

Silylation can be catalyzed either acidic by addition of TMCS or basic by addition of pyridine or TSIM (e.g., for sterically hindered functionalities like tert. alcohols).

Reactivity of silylation reagents (acc. to M. Donike): TMS amide (e.g., BSA, MSTFA) > TMS amine = TSIM > Enol-O-TMS ether > S-TMS ether > O-TMS ether > TMS-O-TMS

Stability of the TMS derivatives: O-TMS ether > S-TMS ether > Enol-O-TMS ether > TMS amine > TMS amide

BSA *N,O*-bis-trimethylsilyl-acetamide

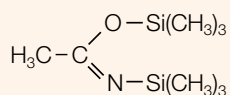

• M 203.4 g/mol,
Bp 71–73 °C (35 mm Hg),
Density $d_{20^\circ/4^\circ} = 0.832$

★ Key features

- Strong silylation reagent
- Not recommended for use with carbohydrates or very low molecular weight compounds
- Good solvent for polar compounds, but frequently used in combination with a solvent (pyridine, DMF etc.) or with other silylation reagents. Dissolved in DMF, BSA is the prime derivatization reagent for phenols.

✔ Recommended application

- Alcohols, amines, carboxylic acids, phenols, steroids, biogenic amines and alkaloids are derivatized to stable TMS derivatives

BSTFA *N,O*-bis-trimethylsilyl-trifluoroacetamide

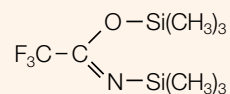

• M 257.4 g/mol,
Bp 40 °C (12 mm Hg),
Density $d_{20^\circ/4^\circ} = 0.961$

★ Key features

- Powerful trimethylsilyl donor with approx. the same donor strength as the nonfluorinated analog BSA
- Advantage of BSTFA over BSA: greater volatility of its reaction products, particularly useful for GC analysis of low boiling TMS amino acids

- BSTFA is nonpolar (less polar than MSTFA) and can be mixed with acetonitrile for improved solubility. For the silylation of fatty acid amides, hindered hydroxyl groups and other difficult to silylate compounds, e.g., secondary alcohols and amines, we recommend BSTFA + 1 % trimethylchlorosilane (TMCS), available under the designation SILYL-991 (see page 366).

Silylation with BSA, BSTFA or SILYL-991 (BSTFA + 1 % TMCS)

- Procedure see page 367 or online at www.mn-net.com/apps
- | | |
|-----------|---------------------|
| BSA | MN Appl. Nr. 213091 |
| BSTFA | MN Appl. Nr. 213092 |
| SILYL-991 | MN Appl. Nr. 213093 |

Silylation with BSA in combination with other silylation reagents

- Procedure see page 367 or online at www.mn-net.com/apps
- | |
|---------------------|
| MN Appl. Nr. 213100 |
|---------------------|



Ordering information

Silylation reagents*

Substance	Packing unit				
	20 x 1 mL	1 x 10 mL	5 x 10 mL	1 x 50 mL	1 x 100 mL
BSA		701210.110	701210.510	701210.150	
BSTFA	701220.201	701220.110	701220.510		
SILYL-991 –(BSTFA – TMCS (99:1))	701490.201			701490.150	701490.1100

* These products contain harmful substances which must be specially labeled as hazardous. For detailed information please see SDS.

On request for 1 x 10 mL, 1 x 50 mL and 6 x 50 mL also available with screw closure.

MSTFA *N*-methyl-*N*-trimethylsilyl-trifluoroacetamide

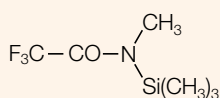

• M 199.1 g/mol,
Bp 70 °C (75 mm Hg),
Density d_{20°/4°} = 1.11

★ Key features

- The most volatile trimethylsilyl amide available, very strong TMS donor which does not cause noticeable FID fouling even during long-time measuring series

✔ Recommended application

- Carboxylic acids, hydroxy and ketocarboxylic acids, amino acids, amines, alcohols, polyalcohols, sugars, mercaptans and similar compounds with active hydrogen atoms. Even amine hydrochlorides can be silylated directly.

• The addition of protic solvents in submolar quantities, e.g., TFA for extremely polar compounds (hydrochlorides) or pyridine for carbohydrates, can improve the already good dissolving power of MSTFA.

• Advantages: complete conversion with high reaction rates, even without a catalyst (1–2 % TMCS or TSIM); the by-product of the reaction (*N*-methyltrifluoroacetamide) shows a high volatility and a short retention time

MSHFBA *N*-methyl-*N*-trimethylsilyl-heptafluorobutyramide

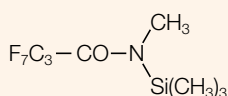

• M 299.1 g/mol,
Bp 148 °C (760 mm Hg)

★ Key features

- Similar to MSTFA in reactivity and chromatography
- Either applied alone or in combination with a catalyst (TMCS, TSIM) or another silylation reagent with or without solvent; the by-product *N*-methylheptafluorobutyric amide has a lower retention time than the silylating reagent

✔ Recommended application

- Carboxylic acids, alcohols, phenols, primary and secondary amines and amino acids

• Especially useful for flame ionization detection due to the large ratio of fluorine to silicon of 7:1, since degradation of the surplus MSHFBA does not produce SiO₂ but volatile, non-corrosive silicon compounds

MBDSTFA *N*-methyl-*N*-*tert*-butyldimethylsilyl-trifluoroacetamide

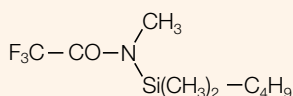

• M 241.3 g/mol,
Bp 170 °C (760 mm Hg),
Density d_{20°/4°} = 1.121

★ Key features

- Silylation reagent that donates a *tert*-butyldimethylsilyl group (TBDMS) for derivatizing active hydrogen atoms in hydroxyl, carboxyl and thiol groups as well as primary and secondary amines
- Fast reactions (typically 5–20 min) with high yields (> 96 %), by-products are neutral volatiles

- TBDMS ethers are 10⁴ times more stable than the corresponding TMS ethers
- Due to the large protecting group, chromatographic retention times are longer. This may have a beneficial impact on some separations. The high concentration of M⁺-57 ions is an interesting topic for GC/MS.

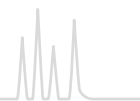

Silylation with MSTFA, MSHFBA or MBDSTFA

· Procedure see page 367 or online at www.mn-net.com/apps

MSTFA MN Appl. Nr. 213111 · MSHFBA MN Appl. Nr. 213112 · MBDSTFA MN Appl. Nr. 213113

Ordering information

Silylation reagents*

Substance	Packing unit							
	10 x 1 mL	20 x 1 mL	1 x 10 mL	5 x 10 mL	1 x 100 mL	6 x 50 mL	6 x 100 mL	12 x 100 mL
MSTFA		701270.201	701270.110	701270.510	701270.1100	701270.650	701270.6100	701270.12100
MSHFBA		701260.201	701260.110	701260.510	701260.1100		701260.6100	
MBDSTFA	701440.101	701440.201						

* These products contain harmful substances which must be specially labeled as hazardous. For detailed information please see SDS.

On request for 1 x 10 mL, 1 x 50 mL and 6 x 50 mL also available with screw closure.



Ultrapure derivatization reagents for acylation, alkylation and silylation.



DMCS Dimethyldichlorosilane

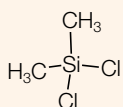

• M 129.06 g/mol,
Bp 70 °C (760 mm Hg),
Density d_{20°/4°} = 1.07

★ Key features

- Used to form dimethylsilyl (DMS) derivatives
- DMS derivatives are much more susceptible to hydrolysis than TMS derivatives, it is therefore vital to have strictly anhydrous conditions during the conversion.

HMDS Hexamethyldisilazane

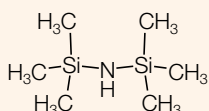

• M 161.4 g/mol,
Bp 126 °C (760 mm Hg),
Density d_{20°/4°} = 0.7742

★ Key features

- Weak TMS donor; used as a sole reagent, it is slow and not very effective.
- Aprotic solvents like acetonitrile, pyridine, dimethylformamide, carbon disulfide and dimethylacetamide recommend themselves for use with HMDS.
- With catalytic quantities, e.g., 1 % of, or as a mixture with TMCS (2:1, v/v; SILYL-21 and SILYL-2110) it is perfectly suited for a quick and quantitative trimethylsilylation of organic compounds.

TMCS Trimethylchlorosilane

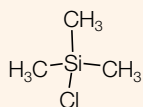

• M 108.7 g/mol,
Bp 57 °C (760 mm Hg),
Density d_{20°/4°} = 0.8580

★ Key features

- Often used as a catalyst with other trimethylsilyl reagents
- As a sole reagent, it can be used to prepare TMS derivatives of organic acids.

TSIM *N*-trimethylsilyl-imidazole

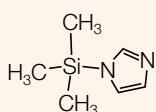

• M 140.3 g/mol,
Bp 94–96 °C (760 mm Hg),
Density d_{20°/4°} = 0.961

★ Key features

- Strongest hydroxyl silylator
- It is remarkable that TSIM reacts quickly and smooth with hydroxyl (even tert. OH) and carboxyl groups, but not with amines. Hence it is especially suited for multiple derivatizations, when compounds with various functional groups are to be derivatized in different ways (e.g., -O-TMS, -*N*-HFB derivatives of catecholamines).

✓ Recommended application

- Alcohols, phenols, organic acids, steroids, hormones, glycols, nucleotides, narcotics
- Reagent of choice for carbohydrates and most steroids (even strongly hindered steroids)

Silylation with TSIM or SILYL-1139 (TSIM – pyridine 11:39)

• Procedure see page 367 or online at www.mn-net.com/apps

apps

TSIM: MN Appl. Nr. 213121

SILYL-1139: MN Appl. Nr. 213122



Ordering information

Silylation reagents*

Substance	Packing unit			
	20 x 1 mL	1 x 10 mL	5 x 10 mL	6 x 50 mL
DMCS				701230.650
HMDS			701240.510	701240.650
TMCS	701280.201			701280.650
TSIM	701310.201	701310.110	701310.510	

* These products contain harmful substances which must be specially labeled as hazardous. For detailed information please see SDS.

On request for 1 x 10 mL, 1 x 50 mL and 6 x 50 mL also available with screw closure.

Ordering information

Reagent mixtures for silylation*

Mixture	Composition	Packing unit				
		20 x 1 mL	1 x 10 mL	5 x 10 mL	1 x 50 mL	1 x 100 mL
SILYL-271	BSA - HMDS - TSIM (2:7:1)	701450.201	701450.110	701450.510		
SILYL-1139	TSIM - Pyridine (11:39)	701460.201				
SILYL-21	HMDS - TMCS (2:1)	701470.201				
SILYL-2110	HMDS - TMCS - Pyridine (2:1:10)	701480.201				
SILYL-991	BSTFA - TMCS (99:1)	701490.201			701490.150	701490.1100

* These products contain harmful substances which must be specially labeled as hazardous. For detailed information please see SDS.

On request for 1 x 10 mL, 1 x 50 mL and 6 x 50 mL also available with screw closure.

Due to their purpose, derivatization reagents are very reactive substances. For this reason, they should be stored cool and protected from moisture. For easy access with a syringe, our derivatization reagents are supplied in vials with crimp caps (exception DMCS and TMCS with screw closure). Vials with pierced sealing disks have limited stability and should be used soon.

Silylation with SILYL-21 or SILYL-2110

- Recommended applications: sugars, glycols, sterically unhindered alcohols, carboxylic acids, acids in urine, hydroxy fatty acids, nucleotides, steroids, vitamin D, xanthone derivatives
 - Procedure see page 367 or online at www.mn-net.com/apps
- SILYL-21 MN Appl. Nr. 213131
SILYL-2110 MN Appl. Nr. 213132

O-trimethylsilylation with MSTFA followed by N-trifluoroacetylation with MBTF

- Procedure see page 367 or online at www.mn-net.com/apps
- MSTFA/MBTFA MN Appl. Nr. 213140





Acylation

with fluorinated acid anhydrides · TFAA MN Appl. No. 213041 · HFBA MN Appl. No. 213042

Dissolve 0.1 to 1 mg sample in 0.1 mL solvent, add 0.1 mL of the anhydride and heat to 60–70 °C for 1–2 h. If the sample needs not be concentrated prior to the analysis and if there is no danger of catalytically induced side reactions, pyridine is used as solvent. The reaction solution can be injected directly into the gas chromatograph. Otherwise, use a volatile solvent and evaporate solvent, excess reagent and free acid in a stream of nitrogen. Dissolve residue in 50 µL hexane, chloroform etc. and inject aliquot portions.

with fluorinated acid amides · MBTFA MN Appl. No. 213051 · MBHFBA MN Appl. No. 213052

Add 0.5 mL MBTFA or MBHFBA to about 2 mg sample. If there is no reaction at ambient temperature, heat the reaction mixture to 120 °C. Compounds difficult to dissolve, can be trifluoroacetylated in suitable solvent mixtures. It is recommended to use a ratio of solvent to MBTFA or MBHFBA of 4:1. The reaction mixture is chromatographed directly.

Alkylation (Methylation)

with TMSH · MN Appl. No. 213060

Dissolve 100 mg sample (e.g., butter) in 5 mL of a solvent (e.g., *tert.*-butyl methyl ether). Add 50 µL reagent to 100 µL of this solution. The mixture is injected directly. The temperature of the injector must be at least 250 °C.

with DMF-DMA · MN Appl. No. 213070

Add 1 mL of a mixture of DMF-DMA and pyridine (1:1) to 1–50 mg fatty acids. The sample can be injected as soon as a clear solution has formed. It is recommended, however, to heat the solution to 60–100 °C for 10–15 min.

with methanol – TMCS · MN Appl. No. 213080

Add 1 mL methanol – TMCS to about 50 mg carboxylic acid or glyceride and heat. Then evaporate in a stream of nitrogen and dissolve again for injection in, e.g., *n*-heptane.

Silylation

with BSA, BSTFA oder SILYL-991 (BSTFA + 1 % TMCS)

BSA MN Appl. No. 213091 · BSTFA MN Appl. No. 213092 SILYL-991 MN Appl. No. 213093

Add 0.5 mL of the silylation reagent to 1–10 mg sample; if necessary, add some solvent (normally pyridine or DMF [dimethylformamide]). Heat to 60–80 °C for 20 min to increase the reaction rate. 1–2 drops of TMCS (trimethylchlorosilane) or TSIM will also speed up the reaction.

with BSA in combination with other silylation reagents · MN Appl. No. 213100

BSA alone silylates all sterically unhindered hydroxyl groups of the steroid skeleton; addition of TMCS will enable reaction of moderately hindered OH groups (reaction time 3–6 h at 60 °C). After addition of TSIM even strongly hindered hydroxyl groups will react (reaction time 6–24 h at 60 °C).

with MSTFA, MSHFBA or MBDSTFA

MSTFA MN Appl. No. 213111 · MSHFBA MN Appl. No. 213112 · MBDSTFA MN Appl. No. 213113

Dissolve 10–15 mg sample in 0.8 mL solvent, then add 0.2 mL of the silylation reagent. The reaction mixture can be heated to 60–70 °C for up to 1 h and can be analyzed directly. If TFA is used as a solvent, proceed as follows [20]: dissolve 1–2 mg sample in 100 µL TFA. Dropwise add 0.9 mL of the silylating reagent. After cooling the sample can be chromatographed directly.

with TSIM or SILYL-1139 (TSIM – pyridine 11:39) · TSIM MN Appl. No. 213121 · SILYL-1139 MN Appl. No. 213122

Dissolve 10–15 mg sample in 0.8 mL solvent, then add 0.2 mL of the silylation reagent. The reaction mixture can be heated to 60–70 °C for up to 1 hour and can be analyzed directly. Recommended solvent pyridine. When using SILYL-1139, the presence of water does not interfere.

with SILYL-21 or SILYL-2110 · SILYL-21 MN Appl. No. 213131 · SILYL-2110 MN Appl. No. 213132

Carefully add SILYL-21 or SILYL-2110 to 1–10 mg of the sample. Precipitated ammonium chloride does not interfere. If the sample should not dissolve within 5 min, heat to 75–85 °C. If no mutarotation is to be expected, you may dissolve the sugar in warm pyridine first and then add the silylation reagent. In some cases it may be advantageous to use a different solvent instead of pyridine. For derivatization of 3-ketosteroids we recommend to use DMF (dimethylformamide)

O-trimethylsilylation with MSTFA followed by *N*-trifluoroacetylation with MBTFA · MN Appl. No. 213140

Completely silylate 2 mg of the sample with 0.3 mL MSTFA, e.g., as described on page 363. After addition of 0.3 mL MBTFA the *N*-trimethylsilyl group is replaced by the *N*-trifluoroacetyl group. The mixture can be analyzed directly.



Test mixtures

★ Key features

- Test mixtures for GC capillary columns to control the performance of fused silica capillary columns and the GC system

Ordering information

Test mixtures*

Designation		Pack of	REF
Activity test mixture (FA-TMS test according to Donike) in MSTFA/ <i>n</i> -hexane (1 + 4)	1 mg/mL each of TMS capric acid (C10), TMS myristic acid (C14), TMS stearic acid (C18), TMS behenic acid (C22), hexadecane (C16), eicosane (C20), tetracosane (C24), octacosane (C28)	1 mL	722307
Grob test mixture (modified) in <i>n</i> -hexane	(in mg/mL) <i>n</i> -decane (~ 2.8), <i>n</i> -undecane (~ 2.9), <i>n</i> -octanol (~ 3.6), 2,6-dimethylphenol (~ 3.2), 2,6-dimethylaniline (~ 3.2), methyl decanoate (~ 4.2), dicyclohexylamine (~ 3.1), methyl undecanoate (~ 4.2), methyl dodecanoate (~ 4.1)	1 mL	722310
MN OPTIMA® test mixture in pentane	0.1 % each of undecane, dodecane, octanol, dimethylaniline, decylamine, methyl decanoate, methyl undecanoate, heneicosane, docosane, tricosane (chromatograms see page 305)	1 mL	722316
MN OPTIMA® amine test mixture in ethanol	0.2 % diisobutylamine, 1 % diethanolamine, 0.2 % 2,6-dimethylaniline, 0.2 % <i>o</i> -propyl-pyridine, 0.2 % dicyclohexylamine, 0.2 % dibenzylamine	1 mL	722317
FAME test mixture in hexane	0.1 % each of FAMEs C4, C6, C8, C10, C12, C14, C16, C18, C18:1 cis, C18:1 trans, C18:2, C18:3, C20, C22, C22:1, C24 (chromatogram see page 334)	1 mL	722320

* These products contain harmful substances which must be specially labeled as hazardous. For detailed information please see SDS.

Grob test mixture (modified) (REF 722310)

MN Appl. No. 211250

Column: OPTIMA® 5, 50 m x 0.25 mm ID, 1.0 µm film
Injection: 1 µL, split 1:40, 280 °C
Carrier gas: 1.5 bar H₂
Temperature: 80 °C → 280 °C (10 min), 8 °C/min
Detector: FID 280 °C

Peaks:

1. *n*-Decane
2. 1-Octanol
3. *n*-Undecane
4. 2,6-Dimethylphenol
5. 2,6-Dimethylaniline
6. Methyl decanoate
7. Methyl undecanoate
8. Dicyclohexylamine
9. Methyl dodecanoate

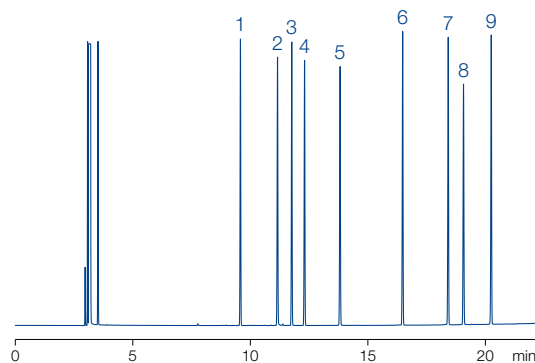



Test mixtures for GC capillary columns

Activity test mixture (REF 722307)

MN Appl. No. 211240

Column: OPTIMA® 5, 25 m x 0.32 mm ID, 1.0 µm film
Injection: 1 µL, split 1:40, 300 °C
Carrier gas: 0.6 bar H₂
Temperature: 150 °C → 300 °C (8 min), 10 °C/min
Detector: FID 300 °C

Peaks:

1. TMS capric acid (C₁₀)
2. Hexadecane (C₁₆)
3. TMS myristic acid (C₁₄)
4. Eicosane (C₂₀)
5. TMS stearic acid (C₁₈)
6. Tetracosane (C₂₄)
7. TMS behenic acid (C₂₂)
8. Octacosane (C₂₈)

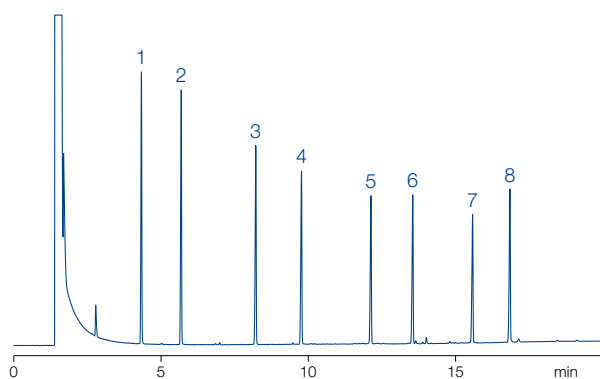

OPTIMA® Amine test mixture (REF 722317)

MN Appl. No. 250020

Column: OPTIMA® 5 Amine, 30 m x 0.32 mm ID, 1.5 µm film
Injection: 1 µL, split 1:40
Carrier gas: 0.6 bar H₂
Temperature: 100 °C → 280 °C, 10 °C/min
Detector: FID 280 °C

Peaks:

1. Diisobutylamine
2. Diethanolamine
3. 2,6-Dimethylaniline
4. o-Propanol-pyridine
5. Dicyclohexylamine
6. Dibenzylamine

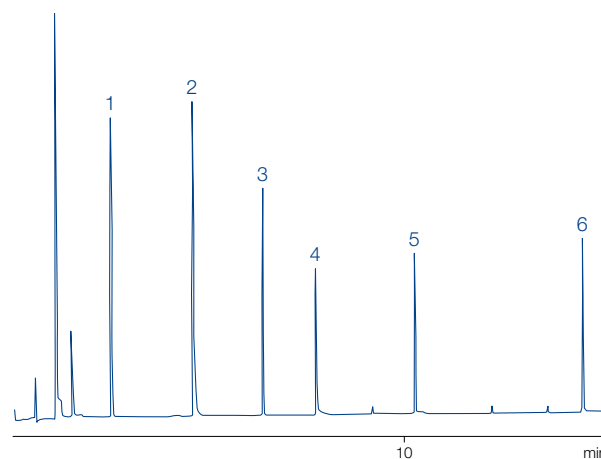



Ferrules for capillary columns



Ferrules

★ Key features

- Graphite ferrules provide the highest temperature stability (up to 450 °C). They are reusable, if handled with care. We also offer 1/16" graphite ferrules specially designed for Carlo Erba / Fisons or for Agilent gas chromatographs.
- Vespel ferrules with 40 % graphite. Temperature-stable up to 400 °C and reusable.

Ordering information

Ferrules

Bore (= column OD)	Graphite	Vespel +40 % Graphite
$T_{\max} \rightarrow$	450 °C	400 °C
1/16" ferrules		
0.4 mm		706246
0.5 mm	708308	
1/16" ferrules for Carlo Erba (Fisons) instruments		
0.8 mm	708340	
1/16" ferrules for Hewlett-Packard (Agilent) instruments		
0.4 mm	708353	
0.5 mm	708354	
0.8 mm	708355	
1/8" ferrules		
no bore	708341	
1/4" ferrules		
no bore	708344	
0.4 mm	708345	
0.5 mm	708346	



Septa for capillary column



Injection Port Septa blister pack for cleanliness and easily handling

★ Key features

- BTO septa for highest demands in GC and GC-MS
 - pierced, soft – CenterGuide™
- AG3 septa with higher durability than BTO
 - pierced, hard – CenterGuide™
- Marathon Septa with extreme durability for > 400 injections
 - pierced – CenterGuide™

Ordering information

Injection port septa

Septum grade	BTO septa	AG3 septa	Marathon septa	
				
OD	T_{max}			
9 mm	400 °C	702646	702656	702660
11 mm	400 °C	702647	702657	702661
11.5 mm	400 °C	702648	702658	702662
Shimadzu®	300 °C	702649	702659	702663
	Pack of	25	25	25





Standard Septa in classical plastic container

★ Key features

- Standard septa (ST) beige silicone, 60° shore A, 4 mm
- High temperature septa (HT) red non-bleeding silicone, 60° shore A, 3 mm (320 °C max.)
- Silicone septa soft, transparent
- Silicone / PTFE septa white silicone, one side coated with grey PTFE, 3 mm

Ordering information

Classical septa

Septum grade	Standard septa (ST)	High temperature septa (HT)	Silicone septa	Silicone septa / PTFE
				
OD				
9 mm	702609	702619	702602	
10 mm	702610	702620		702625
11 mm	702611	702621	702604	702626
12 mm	702612	702622	702605	702627
13 mm	702613	702623	702606	702628
17 mm		702632		
	Pack of	50	50	50

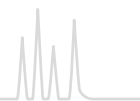

Connectors for capillary GC columns

★ Key features

• Glass connectors for fused silica capillary columns from 0.2 to 0.53 mm ID: manufactured from deactivated glass with slightly tapered inner diameter; used to join two fused silica capillaries of equal or different diameters. Advantages compared to stainless steel fittings are easy connection without tools, optical control during connection, negligible heat capacity and no dead volume.

• Graphseal ferrules for capillary columns: a stainless steel ferrule filled with graphite – the ideal sealing material for capillaries. The capillary is mounted on a 1/16" exit (detector, injector etc.), with the appropriate ferrule, a nut (with slit) and an adapter (see table below).

Ordering information

Connectors for capillary GC columns

Description	Pack of	REF
Graphseal ferrules for capillary columns		
0.4 mm bore	10 ferrules	708337
0.5 mm bore	10 ferrules	708318
0.8 mm bore	10 ferrules	708319
Universal capillary glass connectors		
linear	5 connectors	707971
linear	10 connectors	707972
Y splitter	1 connector	707973

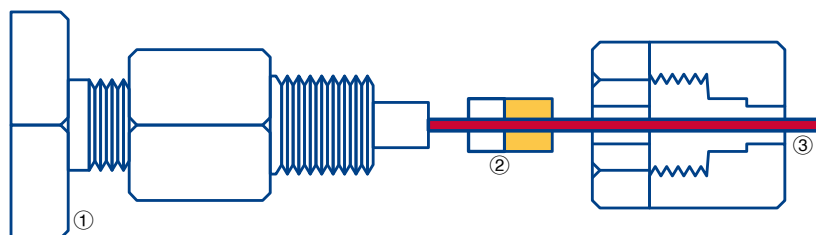

- ① 1/16" exit
- ② Graphseal ferrule
- ③ Capillary



Tools and general accessories for GC

★ Key features

- Magnifying lens with scale: an essential tool for any laboratory. In capillary GC it is often important to inspect column integrity or check cut ends of capillaries. When closing a column by melting the magnifying lens can be used to check whether the column is really closed or whether an open channel has been formed in the sealed end. Our lens provides 8fold magnification and is supplied with a scale as pictured in the figure below. The space between lines is equivalent to 1/10 mm.
- Diamond file: a useful tool for cutting capillaries and smoothing ends of capillaries. Square capillary ends are especially important for butt connections (e.g., in Valco unions).
- Glass wool, quartz wool and glass fiber wadding are used for, e.g., GC liners, packed GC columns etc.

Ordering information

Tools and general accessories

Description	Pack of	REF	
Tools for capillary GC			
Diamond file	for cutting capillaries and straightening capillary ends	1	708300
Magnifying lens with scale	magnification 8x	1	706296
PTFE tape for sealing, reels 12 m long, 12 mm wide, 0.1 mm thick	1 reel		706512
Glass wool			
Glass wool, long fibers, DMCS treated, for packed GC columns	50 g		706201
Glass fiber wadding silanized, very fine fibers	25 g		718002
Quartz wool, very fine fibers	25 g		718587

Index of reference numbers

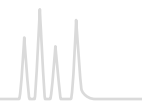

REF	Page	REF	Page	REF	Page	REF	Page
531011	295	702001	111	702054	124	702128	130
701110.110	360	702002	101	702055	125	702129	130
701110.201	360	702004	102, 120	702056	129	70213	102, 120
701110.510	360	702005	102, 109	702057	130	70213.2	102, 120
701120.101	360	702006	105	702058	132	702130	132
701130.110	360	702007	105	702059	132	702131	131
701130.510	360	702008	105	70206.36	127	702132	131
701210.110	363	702009	105	702060	132	702133	131
701210.150	363	702010	105	702061	132	702134	111, 114
701210.510	363	702011	108	702062	132	702135	105
701220.110	363	702012	108	702063	115	702136	125
701220.201	363	702013	108	702063.2080	115	702141	111
701220.510	363	702014	111	702064	115	702144	130
701230.650	366	702015	111	702065	112	702145	129
701240.510	366	702016	111	702066	103, 120	702146	112
701240.650	366	702017	124	702067	103	702147	106
701260.110	364	702018	124	702068	103, 120	702148	107
701260.1100	364	702019	123	702069	103	702155	106
701260.201	364	70201CG	109	702070	103	70214CG	109
701260.510	364	70201HP	110	702071	129	70215.36	126
701260.6100	364	70201HP.2	110	702072	125	702158	106
701270.110	364	70202.1	124	702073	132	702159	106
701270.1100	364	702020	126	702074	131	70216.36	126
701270.12100	364	702021	131	702075	110	702160	106
701270.201	364	702022	131	702076	110	702161	106
701270.510	364	702023	131	702077	104, 108, 110, 114	702162	106
701270.6100	364	702024	131			702163	106
701270.650	364	702025	101	702078	104, 120	702164	106
701280.201	366	702026	105	702079	104, 120	702165	106
701280.650	366	702027	105	70208.36	128	702168	132
701310.110	366	702028	105	702080	106	70217.36	127
701310.201	366	702029	106	702081	106	702170	115
701310.510	366	70203	118	702082	106	702172	105
701410.110	360	702030	106	702083	106	702173	111, 114
701410.201	360	702031	106	702084	106	702174	111, 114
701410.510	360	702032	106, 120	702085	106	702175	112
701420.101	360	702033	106, 120	702086	127	702176	115
701420.201	360	702034	106, 120	702088	105	702177	105
701430.110	361	702035	106	70209.1	128	702178	105
701430.201	361	702036	106	702091	129	702179	105
701440.101	364	702037	106	702093	129	702180	121
701440.201	364	702038	106	702094	129	702181	122
701450.110	366	702039	106	702096	121	702201	107
701450.201	366	70204.36	126	702097	121	702202	107
701450.510	366	702040	106	702098	122	702203	107
701460.201	366	702041	107	702099	122	702204	107
701470.201	366	702042	107	70210.36	128	702205	107
701480.201	366	702043	107	702100	128	702206	107
701490.1100	363, 366	702044	108	702101	130	702207	107
701490.150	363, 366	702045	108	702101HP	113	702208	107
701490.201	363, 366	702046	108	702102	132	702209	107
701520.101	361	702047	108	702103	119, 121	702211	107
701520.110	361	702048	108	702104	121	702212	107
701520.201	361	702049	108	702105	122	702213	107
701520.510	361	70205.36	126	702106	122	702214	107
701950	357	702050	119	702107	106	702215	112
701951	357	702051	119, 121	702109	106	702216	112
701952	357	702052	119, 121	702110	125	702217	112
701953	357	702053	119	702112	129	702218	112

Index of reference numbers

REF	Page	REF	Page	REF	Page	REF	Page
702219	112	70240	130	70267	130	702827	125
702221	112	702401	111, 115	70269	130	702829	129
702222	112	70242	130	702709	114	70283	101
702223	112	702437	103	70271	123	702833	129
702224	112	70245	103	702710	115	702834	129
702225	115	70248	103	702710.1	115	702835	129
702226	107	702481	103	702710.2080	115	702836	129
702227	115	70249	103	702712	114	702837	129
702228	115	70250	103	702713	114	702838	129
702229	115	702500	104	702714	114	70284	112
702231	115	702502	116, 133	702716	104, 108, 110, 114	70285	121
702232	115	702504	118, 133	702717.2	115	702857	107
702233	115	70251	101	702717.2080	115	702858	107
702234	115	702514	116, 133	702718	115	702859	113
702235	115	702515	118, 133	702718.1	115	70286	101
702236	115	702516	125, 126, 133	702718.2080	115	702860	102
702237	115	702517	131, 133	702719	115	702863	107
702238	103	70252.1	101	70272	123	702864	107
702244	107	70254	127	70273	123	702865	132
702246	103	702540	127	702730	111	702866	125
702247	103	702541	127	702730.1	111	702867	113
702248	103	70256	111	702730.2	111	702873	107
702249	103	70257	118	702730.3	111	702874	107
702251	103	70260	119	702731	115	702877	132
702253	112	702602	371	702732	106	702878	101
702254	112	702604	371	70274	123	702879	112
702261	127	702605	371	70275	123	70288	111
702263	127	702606	371	70277	130	70288.1	111
702263.2	127	702609	371	702773	129	70288.2	111
702282	104, 120	70261	103	702774	129	70288.3	111
702283	104, 120	702610	371	702775	129	702881	113
702284	104, 120	702611	371	70278	130	702885	110
702286	106	702612	371	702780	130	702888	111
702287	106	702613	371	70279	130	70289	101
702287.1	106	702619	371	702791	132	702891	111
702288	106	70262	112	702799	129	702892	110
702288.1	106	702620	371	702800	101	702893	102, 120
702292	119	702621	371	702801	112	702904	130
702293	104, 120	702622	371	702802	118	702917	126
70231	111	702623	371	702803	118	702918	126
70231.1	111	702625	371	702804	129	702924	126
70231.2	111	702626	371	702805	130	702926	119
70231.3	111	702627	371	702807	124	702927	129
70231.4	111	702628	371	702808	129	702928	129
702311	121	702632	371	702808	129	702928.9	129
70232	118	702646	371	702809	111, 114	702929	129
70233	130	702647	371	702813	104, 108, 110, 114	702931	130
702334	111, 114	702648	371	702818	104, 108, 110, 114	702931.1	130
702335	105	702649	371	702818.1	104, 108, 110, 114	702962	119, 121
70234	129	702656	371	70282	101	702963	119
70234.8	129	702657	371	702823	111	702966	119
70234.9	129	702658	371	702824	102, 109	702968	102, 109
70234.10	129	702659	371	702825	104, 108, 110, 114	702968.1	102, 109
70235	130	70266	130	702826	125	702972	119
70236	130	702660	371	702826.2	125	702973	119, 121
70236.1	130	702661	371			702974	119
70237	129	702662	371			702974.1	102
70238	130	702663	371			702981	125
70239	111					702995	112

Index of reference numbers

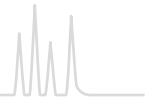

REF	Page	REF	Page	REF	Page	REF	Page
702995.1	112	711018.100	258	711350.100	257	711890.10	257
702995.2	112	711018.1000	258	711360.10	257	711890.100	257
702995.3	112	711019.100	258	711360.100	257	711991.10	257
702D20TB	130	711019.1000	258	711370.10	257	711991.100	257
706201	373	711020.10	257	711370.100	257	711992.10	257
706246	370	711020.100	257	711380.10	257	711992.100	257
706290	254	711021.100	258	711380.100	257	713550.0100	256
706296	373	711021.1000	258	711390.10	257	713550.1	256
706512	373	711022.100	258	711390.100	257	713551.0100	256
707971	372	711022.1000	258	711420.10	257	713551.1	256
707972	372	711023.100	258	711420.100	257	713600.0100	256
707973	372	711023.1000	258	711430.10	257	713600.1	256
708300	373	711024.100	258	711430.100	257	713601.0100	256
708308	370	711024.1000	258	711470.100	258	713601.1	256
708318	372	711025.100	258	711470.1000	258	713610.0100	256
708319	372	711025.1000	258	711480.100	258	713610.1	256
708337	372	711026.100	258	711480.1000	258	713611.0100	256
708340	370	711026.1000	258	711490.100	258	713611.1	256
708341	370	711027.100	258	711490.1000	258	713615.0100	256
708344	370	711027.1000	258	711500.100	258	713615.1	256
708345	370	711028.100	258	711500.1000	258	713618.0100	256
708346	370	711028.1000	258	711510.10	257	713618.1	256
708353	370	711029.100	258	711510.100	257	713620.0100	256
708354	370	711029.1000	258	711520.10	257	713620.1	256
708355	370	711031.100	258	711520.100	257	713621.0100	256
711001.1000	259	711031.1000	258	711530.10	257	713621.1	256
711001.5000	259	711032.100	258	711530.100	257	713630.0100	256
711002.1000	259	711032.1000	258	711540.1000	259	713630.1	256
711002.5000	259	711033.1000	259	711540.5000	259	713631.0100	256
711003.1000	259	711033.5000	259	711550.1000	259	713631.1	256
711003.5000	259	711034.1000	259	711550.5000	259	713831.0100	256
711004.100	259	711034.5000	259	711560.10	257	713831.1	256
711004.1000	259	711035.100	259	711560.100	257	713832.0100	256
711005.100	259	711035.1000	259	711570.10	257	713832.1	256
711005.1000	259	711036.100	259	711570.100	257	718002	79, 373
711006.100	259	711036.1000	259	711580.10	257	718582	254
711006.1000	259	711037.1000	259	711580.100	257	718583	254
711007.100	258	711037.5000	259	711590.100	258	718584	254
711007.1000	258	711240.1000	259	711590.1000	258	718587	373
711008.100	258	711240.5000	259	711600.10	257	718637	254
711008.1000	258	711250.1000	259	711600.100	257	718755	255
711009.100	258	711250.5000	259	711610.100	259	718760	255
711009.1000	258	711260.1000	259	711610.1000	259	718761	255
711010.10	257	711260.5000	259	711620.100	259	718762	255
711010.100	257	711270.1000	259	711620.1000	259	718763	255
711011.100	258	711270.5000	259	711630.100	259	718765	255
711011.1000	258	711280.10	257	711630.1000	259	718766	255
711012.100	258	711280.100	257	711680.10	257	718767	255
711012.1000	258	711300.10	257	711680.100	257	718768	255
711013.100	258	711300.100	257	711690.100	258	718769	255
711013.1000	258	711310.10	257	711690.1000	258	718770	255
711014.100	258	711310.100	257	711700.100	258	718771	255
711014.1000	258	711320.10	257	711700.1000	258	718772	255
711015.100	258	711320.100	257	711710.10	257	718775	255
711015.1000	258	711330.10	257	711710.100	257	718966	251
711016.100	258	711330.100	257	711720.100	258	718967	251
711016.1000	258	711340.10	257	711720.1000	258	718968	251
711017.100	258	711340.100	257	711730.100	258	718969	251
711017.1000	258	711350.10	257	711730.1000	258	718970	251

Index of reference numbers

REF	Page	REF	Page	REF	Page	REF	Page
718971	251	720018.46	215	720120.46	214	720841.46	214
718975	253	720019.40	220	720124.40	232	720905.40	246
718976	253	720019.46	220	720125.40	232	720923.30	229
718977	253	720022.40	217	720127.40	232	720923.40	229
718978	253	720022.46	217	720133.40	214	720935.40	215
719402	249	720023.40	215	720133.46	214	720935.46	215
719403	249	720023.46	215	720140.46	215	720936.40	215
719404	249	720024.40	222	720141.40	214	720936.46	215
719405	249	720024.46	222	720141.46	214	720949.46	214
719406	249	720025.46	221	720143.46	220	720951.46	215
719409	249	720028.46	223	720149.40	215	720956.46	220
719410	249	720029.46	223	720149.46	215	720989.46	223
719411	249	720040.40	215	720150.40	214	720990.46	217
719412	249	720040.46	215	720150.46	214	720994.46	221
719413	249	720041.40	215	720165.46	217	720996.40	223
719414	249	720041.46	215	720170.40	216	720996.46	223
719418	249	720042.40	215	720170.46	216	721020.30	221
719454	245	720043.40	215	720174.46	216	721022.30	214
719455	245	720043.46	215	720175.40	216	721024.30	223
719456	245	720046.40	234	720175.46	216	721025.30	223
719459	245	720050.40	217	720182.46	223	721030.30	219
719460	245	720050.46	217	720183.46	223	721039.30	222
719469	240	720051.40	215	720191.40	215	721061.30	217
719475	240	720051.46	215	720191.46	215	721070.30	215
719489	254	720052.40	217	720193.46	215	721071.30	218
719501	248	720052.46	217	720194.46	218	721072.30	215
719520	245	720055.40	215	720196.40	218	721073.30	215
719530	248	720055.46	215	720196.46	218	721074.20	214
719531	248	720057.40	222	720205.40	222	721074.30	214
719532	248	720057.46	222	720205.46	222	721075.30	215
719533	230	720059.40	219	720214.46	217	721078.30	222
719534	248	720059.46	219	720231.40	243	721083.30	219
719535	248	720062.46	217	720245.40	243	721085.30	216
719536	248	720065.40	216	720252.40	244	721093.30	217
719537	248	720065.46	216	720258.40	244	721095.30	217
719538	250	720071.40	217	720280.40	215	721096.30	217
719539	250	720071.46	217	720280.46	215	721119.30	243
719540	240	720074.46	216	720294.46	215	721133.30	215
719542	245	720077.46	216	720296.40	215	721137.30	220
719543	230	720081.40	235	720296.46	215	721142.30	220
719570	247	720088.40	236	720305.46	215	721155.30	221
719571	247	720089.46	219	720350.40	236	721157.30	216
719574	247	720090.40	222	720430.40	215	721158.30	221
719575	247	720090.46	222	720430.46	215	721167.30	224
719600	240	720093.46	224	720431.40	215	721168.20	229
720001.40	217	720094.40	230	720431.46	215	721168.30	229
720001.46	217	720095.46	221	720432.46	215	721169.30	230
720002.20	214	720095.46RP	221	720445.46	233	721170.30	246
720002.30	214	720096.46	219	720450.46	233	721171.30	232
720002.40	214	720097.40	223	720451.46	233	721176.30	232
720002.46	214	720097.46	223	720471.46	215	721178.30	232
720013.40	217	720098.46	214	720472.40	215	721185.30	233
720013.46	217	720099.46	224	720472.46	215	721186.30	233
720014.20	214	720110.46	215	720701.46	215	721188.30	235
720014.30	214	720117.20	229	720709.46	223	721190.30	236
720014.40	214	720117.30	229	720730.46	215	721194.30	217
720014.46	214	720117.40	229	720735.46	217	721196.30	215
720017.46	217	720117.46	229	720740.46	215	721402.30	234
720018.40	215	720120.40	214	720752.40	232	721469.30	232

Index of reference numbers

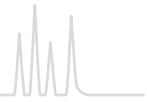

REF	Page	REF	Page	REF	Page	REF	Page
721473.30	214	723327.25	354	723555.50	338	725812.25	316
721518.30	224	723341.25	338	723558.10	355	725812.60	316
721567.30	244	723341.30	338	723558.25	355	725813.30	316
721649.30	215	723341.50	338	723560.10	355	725815.12	316
721823	247	723341.60	338	723560.25	355	725815.50	316
721916.30	219	723344.10	338	723562.10	355	725820.15	316
721920	232	723344.25	338	723562.25	355	725820.30	316
721924.30	244	723344.30	338	723706.10	356	725820.60	316
722307	368	723344.50	338	723706.25	356	725825.30	316
722310	368	723344.60	338	723707.10	356	725825.60	316
722316	368	723346.10	355	723707.25	356	725826.30	316
722317	368	723346.25	355	723708.10	356	725826.60	316
722320	368	723348.10	355	723708.25	356	725850.30	317
722393	229	723348.25	355	723709.10	356	725850.60	317
722394	147	723349.10	355	723709.25	356	726022.15	327
723052.25	336	723349.25	355	723710.10	356	726022.25	327
723052.50	336	723356.25	338	723710.25	356	726022.30	327
723054.25	336	723356.50	338	723711.10	356	726022.50	327
723060.10	337	723358.25	345	723711.25	356	726022.60	327
723060.25	337	723358.50	345	723712.10	356	726024.10	310, 341
723060.30	337	723360.25	342	723712.25	356	726024.20	310, 341
723060.50	337	723360.50	342	723713.10	356	726025.20	310, 341
723060.60	337	723362.25	342	723713.25	356	726038.10	310
723063.25	354	723362.50	342	723714.10	356	726038.15	310
723064.10	337, 341	723364.25	342	723714.25	356	726038.25	310
723101.10	355	723364.50	342	723790.1	355	726038.30	310
723101.25	355	723366.25	342	723790.2	355	726038.60	310
723105.10	355	723366.50	342	723791.1	355	726050.10	310
723105.25	355	723368.25	342	723791.2	355	726050.15	310
723106.10	355	723368.50	342	723792.1	355	726050.25	310
723106.25	355	723370.25	345	723792.2	355	726050.30	310
723108.10	355	723370.50	345	723793.1	355	726050.50	310
723108.25	355	723379.25	342	723793.2	355	726050.60	310
723116.10	338	723379.50	342	723827.10	337	726056.10	314
723116.25	338	723381.25	345	723827.25	337	726056.15	314
723116.30	338	723381.50	345	723827.50	337	726056.25	314
723116.50	338	723382.10	341, 342	723830.10	338	726056.30	314
723116.60	338	723383.10	341, 345	723830.25	338	726056.50	314
723148.10	355	723384.25	345	723830.50	338	726056.60	314
723148.25	355	723384.50	345	723890.100	352	726058.10	324
723151.10	355	723386.25	345	723936.25	338	726058.15	324
723151.25	355	723387.25	345	723936.50	338	726058.25	324
723180.10	338, 341	723387.50	345	723945.25	353	726058.30	324
723180.20	338, 341	723388.25	345	723945.50	353	726058.50	324
723181.10	338, 341	723388.50	345	725801.25	313	726058.60	324
723296.10	337	723409.50	354	725801.50	313	726064.30	324
723296.25	337	723411.25	354	725802.30	313	726064.60	324
723296.30	337	723501.10	355	725802.60	313	726065.12	327
723296.50	337	723501.25	355	725805.15	313	726065.25	327
723296.60	337	723515.10	337	725805.30	313	726065.50	327
723306.25	336	723515.25	337	725805.60	313, 315	726066.25	327
723308.50	336	723517.10	337	725806.30	313	726066.50	327
723310.25	336	723517.25	337	725806.60	313	726067.25	327
723312.25	336	723517.30	337	725807.30	313	726067.30	327
723321.10	337	723549.10	337	725807.60	313	726067.50	327
723321.25	337	723549.25	337	725810.25	316	726067.60	327
723321.30	337	723549.30	337	725810.50	316	726080.10	330, 341
723321.50	337	723555.10	338	725811.30	316	726081.10	310
723321.60	337	723555.25	338	725811.60	316	726081.25	310

Index of reference numbers

REF	Page	REF	Page	REF	Page	REF	Page
726081.30	310	726205.60	312	726316.30	314	726382.60	333
726081.50	310	726210.12	315	726316.50	314	726383.30	333
726081.60	310	726210.25	315	726316.60	314	726383.60	333
726089.30	331	726210.50	315	726318.10	324	726400.25	319
726089.50	331	726211.30	315	726318.15	324	726400.50	319
726089.60	331	726212.25	315	726318.25	324	726410.10	319, 341
726090.30	331	726212.50	315	726318.30	324	726410.20	319, 341
726090.60	331	726212.60	315	726318.50	324	726420.30	319
726091.25	331	726213.30	315	726318.60	324	726420.60	319
726091.30	331	726215.12	315	726320.25	324	726421.30	319
726091.50	331	726215.25	315	726320.30	324	726440.30	319
726091.60	331	726215.50	315	726320.50	324	726440.60	319
726095.30	331	726220.15	315	726320.60	324	726441.30	319
726095.60	331	726220.30	315	726321.25	332	726441.60	319
726096.30	331	726220.60	315	726321.30	332	726442.30	319
726096.60	331	726225.30	315	726321.50	332	726442.60	319
726099.25	314	726225.60	315	726321.60	332	726443.30	319
726099.30	314	726226.30	315	726323.10	310	726465.25	320
726099.50	314	726226.60	315	726323.15	310	726465.50	320
726099.60	314	726241.30	335	726323.25	310	726470.30	320
726102.15	349	726241.60	335	726323.30	310	726470.60	320
726102.30	349	726242.30	335	726323.50	310	726480.30	320
726104.15	349	726242.60	335	726323.60	310	726480.60	320
726104.30	349	726243.30	335	726325.15	314	726481.30	320
726106.15	349	726243.60	335	726325.25	314	726481.60	320
726106.30	349	726246.30	335	726325.30	314	726482.30	320
726108.15	349	726246.60	335	726325.50	314	726482.60	320
726108.30	349	726296.25	332	726325.60	314	726483.30	320
726116.25	334	726296.30	332	726341.25	334	726490.10	320, 341
726116.30	334	726296.50	332	726341.30	334	726519.15	310
726116.50	334	726296.60	332	726341.50	334	726519.25	310
726116.60	334	726301.10	310	726341.60	334	726519.30	310
726118.15	330	726301.25	310	726344.25	334	726521.10	310
726118.25	330	726301.30	310	726344.30	334	726521.25	310
726118.30	330	726301.50	310	726344.50	334	726521.30	310
726118.50	330	726301.60	310	726345.30	334	726521.50	310
726118.60	330	726302.10	310	726346.25	334	726523.10	314
726131.10	348	726302.15	310	726351.25	327	726523.25	314
726131.25	348	726302.25	310	726351.30	327	726523.30	314
726132.10	348	726302.30	310	726351.50	327	726525.10	314
726132.25	348	726302.50	310	726351.60	327	726525.25	314
726133.10	348	726302.60	310	726352.25	330	726525.30	314
726133.25	348	726304.10	310	726352.30	330	726525.50	314
726154.30	326	726304.25	310	726352.50	330	726525.60	314
726154.60	326	726304.30	310	726352.60	330	726529.10	310
726157.30	326	726304.50	310	726353.30	350	726529.15	310
726157.60	326	726304.60	310	726354.30	350	726529.25	310
726162.30	328	726313.10	314	726355.25	350	726529.30	310
726162.60	328	726313.15	314	726356.30	350	726541.10	314
726165.30	328	726313.25	314	726357.30	350	726541.15	314
726165.60	328	726313.30	314	726358.30	350	726541.25	314
726180.10	334, 341	726313.50	314	726359.30	350	726541.30	314
726201.25	312	726313.60	314	726360.30	350	726545.10	324
726201.50	312	726314.15	314	726361.10	341, 350	726545.15	324
726202.30	312	726314.25	314	726380.30	333	726545.25	324
726202.60	312	726314.30	314	726380.60	333	726545.30	324
726203.12	312	726314.50	314	726381.30	333	726548.30	332
726205.15	312	726314.60	314	726381.60	333	726549.25	332
726205.30	312	726316.25	314	726382.30	333	726549.30	332

Index of reference numbers

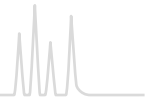

REF	Page	REF	Page	REF	Page	REF	Page
726600.25	332	726777.60	321	726863.25	314	727450	79
726600.30	332	726780.30	321	726863.50	314	727451	79
726600.50	332	726780.50	321	726871.15	329	728031.20	225
726600.60	332	726780.60	321	726871.25	329	728031.30	225
726623.25	314	726783.25	321	726871.30	329	728031.40	225
726623.30	314	726784.25	323	726871.50	329	728031.46	225
726623.50	314	726785.25	323	726871.60	329	728032.20	225
726623.60	314	726785.30	323	726874.30	329	728032.30	225
726628.25	314	726785.50	323	726874.50	329	728032.40	225
726628.30	314	726785.60	323	726874.60	329	728032.46	225
726628.50	314	726786.30	323	726877.15	329	728033.46	225
726628.60	314	726786.50	323	726877.30	329	728034.20	225
726630.30	325	726787.25	323	726877.50	329	728034.30	225
726630.60	325	726787.30	323	726877.60	329	728034.40	225
726631.30	325	726787.50	323	726880.25	329	728034.46	225
726631.60	325	726787.60	323	726880.30	329	728035.20	225
726632.30	325	726789.25	323	726880.50	329	728035.30	225
726632.60	325	726789.30	323	726880.60	329	728035.40	225
726633.30	325	726802.25	310	726900.30	347	728035.46	225
726633.60	325	726802.30	310	726903.10	347	728036.46	225
726634.30	325	726802.50	310	726905.30	347	728037.20	225
726634.60	325	726802.60	310	726911.25	314	728037.30	225
726635.30	325	726805.25	310	726911.30	314	728037.40	225
726635.60	325	726805.30	310	726911.50	314	728037.46	225
726640.30	322	726805.50	310	726911.60	314	728038.20	225
726640.60	322	726805.60	310	726916.10	314	728038.30	225
726641.30	322	726807.25	314	726916.25	314	728038.40	225
726641.60	322	726807.30	314	726916.30	314	728038.46	225
726642.30	322	726807.50	314	726916.50	314	728039.46	225
726642.60	322	726807.60	314	726926.10	310	728053.30	225
726643.30	322	726809.25	314	726926.25	310	728053.40	225
726643.60	322	726809.30	314	726926.30	310	728054.30	225
726735.15	324	726809.50	314	726926.50	310	728054.40	225
726735.25	324	726809.60	314	726929.25	324	728055.30	225
726735.30	324	726821.25	310	726929.30	324	728055.40	225
726735.50	324	726821.30	310	726929.50	324	728777.20	251
726742.25	327	726821.50	310	726929.60	324	728777.30	251
726742.30	327	726821.60	310	726931.10	310	728778.20	251
726742.50	327	726824.25	324	726931.25	310	728778.30	251
726742.60	327	726824.30	324	726931.30	310	729004	89
726744.25	327	726824.50	324	726931.50	310	729004.400	89
726744.30	327	726824.60	324	726934.15	314	729006	89
726744.50	327	726832.25	310	726934.25	314	729006.400	89
726744.60	327	726834.12	310	726934.30	314	729007	88
726747.10	327	726834.25	310	726934.50	314	729007.400	88
726747.15	327	726834.50	310	726965.30	324	729008	88
726747.25	327	726837.12	310	727400	79	729009	88
726747.30	327	726837.25	310	727401	79	729010	90
726755.30	327	726837.50	310	727402	79	729011	90
726757.25	327	726839.50	310	727403	79	729012	90
726757.30	327	726841.25	324	727404	79	729012.400	90
726757.50	327	726841.50	324	727405	79	729013	90
726757.60	327	726846.10	314, 341	727406	79	729013.400	90
726771.25	321	726848.10	327, 341	727407	79	729014	88
726771.30	321	726854.25	314	727420	79	729015	88
726771.50	321	726857.25	314	727421	79	729020	86
726771.60	321	726857.50	314	727422	79	729020.400	86
726777.25	321	726860.25	314	727423	79	729021	86
726777.30	321	726860.50	314	727424	79	729021.400	86

Index of reference numbers

REF	Page	REF	Page	REF	Page	REF	Page
729022	86	729226	89	730014.250	32	730084	38
729023	86	729226.400	89	730014G	32	730085	56
729024	89	729227	89	730015	32	730085.250	56
729025	89	729227.400	89	730015.250	32	730085G	56
729026	89	729228	91	730015ASP	68	730100.4	67
729026.400	89	729228.400	91	730015G	32	730101	67
729027	89	729229	86	730016	32	730102	67
729027.400	89	729229.400	86	730017	43	730103	67
729028	91	729230	87	730018	32	730104.4	67
729028.400	91	729230.400	87	730020	43	730105	67
729030	87	729231	87	730020G	43	730106	66
729030.400	87	729231.400	87	730021	35	730107	39
729031	87	729234	91	730022	35	730107.250	39
729031.400	87	729236	87	730023	35	730107G	39
729032	85	729237	87	730024	35	730108	30
729032.400	85	729240	90	730024G	35	730108.250	30
729033	85	729241	90	730026	67	730108G	30
729033.400	85	729241.400	90	730028	33	730109	54
729034	91	729242	90	730031	40	730111	30
729036	87	729243	91	730033	40	730111.AOX	51
729037	87	729244	91	730033.250	40	730111G	30
729039	85	729245	88	730033G	40	730112	52
729039.400	85	729246	88	730034	67	730117	30
729043	91	729246.400	88	730049	25	730118	30
729044	91	729247	88	730049P45	25	730118G	30
729048	90	729248	90	730051	41	730119	30
729049	90	729249	90	730053	41	730119.AOX	51
729050	85	729254	89	730061	41	730125	56
729050.400	85	729255	89	730063	41	730126	44
729051	85	729256	88	730068.320	94	730127	44
729051.400	85	729257	88	730068.345	94	730130	33
729054	89	729258	92	730068.620	94	730132	55
729055	89	730001	33	730068.645	94	730132.250	55
729100	92	730002	33	730070	39	730134	35
729101	92	730003	33	730070G	39	730135	52
729102	92	730003.250	33	730071	39	730135.250	52
729204	89	730003G	33	730071ASP	68	730135G	52
729204.400	89	730004	33	730072	39	730139	43
729205	88	730004.250	33	730073	39	730139G	43
729205.400	88	730004G	33	730073.250	39	730141	32
729206	89	730005	33	730073ASP	68	730149	54
729207	88	730005.250	33	730073G	39	730149.250	54
729207.400	88	730005G	33	730073MPS	68	730149G	54
729208	88	730007	44	730075	39	730150	65
729209	88	730008	33	730075.250	39	730151	65
729212	90	730009	33	730075ASP	68	730152	66
729212.400	90	730010	32	730075G	39	730153	66
729213	90	730011	32	730075MPS	68	730154	66
729213.400	90	730011ASP	68	730076	45	730157	66
729218	91	730011MPS	68	730077	45	730158	67
729218.400	91	730012	32	730077.250	45	730159	67
729219	91	730012G	32	730078	46	730160	67
729219.400	91	730012MPS	68	730079	46	730161	67
729220	86	730013	32	730079.250	46	730162	67
729220.400	86	730013.250	32	730081	44	730163	67
729221	86	730013ASP	68	730082	44	730164	67
729221.400	86	730013G	32	730082.250	44	730165	60
729222	86	730013MPS	68	730082G	44	730166	51
729223	86	730014	32	730083	38	730166G	51

Index of reference numbers

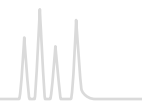

REF	Page	REF	Page	REF	Page	REF	Page
730167	60	730295	34	730444	37	730595.50000	64
730168	48	730296	34	730446	43	730596	42
730168.250	48	730296G	34	730447	43	730601	35
730169	36	730297	34	730452	43	730602	33
730171	67	730297G	34	730453	43	730603	40
730172	67	730298	34	730455	43	730605	41
730173	65	730298G	34	730457	44	730606	38
730174	65	730299	34	730460	47	730607	41
730175	65	730299G	34	730462	47	730608	39
730176	65	730300	34	730464	47	730609	45
730177	65	730300G	34	730466	43	730610	46
730178	65	730301	34	730467	43	730611	32
730179	66	730302	34	730473	39	730612	33
730180	40	730310	31	730474	67	730613	32
730180G	40	730315	50	730475	67	730615	30
730183.12	66	730322	46	730482	47	730616	51
730184.12	66	730323	46	730483	47	730618	52
730185	66	730344	31	730484	47	730618G	52
730187	66	730349	18	730487	64	730619	54
730188	66	730350.4	67	730487.250	64	730620	52
730189.1	66	730351	67	730489	64	730620G	52
730189.12	66	730355	67	730490	18	730622	44
730191	67	730356	67	730491	18	730626	40
730192	67	730360	65	730494	18	730626G	40
730194	66	730365	65	730496	18	730628	34
730197	18	730366	66	730501	64	730629	47
730199	18	730376	31	730502	64	730630	47
730205	18	730377	31	730505	64	730631	37
730206	18	730378	31	730506	64	730640	43
730207	18	730380	67	730507	64	730641	43
730208	18	730381	67	730507.100	64	730642	43
730209	18	730382	67	730508	64	730643	42
730212	45	730384	44	730509	64	730648	59
730214	39	730385	67	730517.3100	94	730651	36
730214G	39	730386	66	730517.6100	94	730652	36
730214MPS	68	730387	66	730533	60	730653	59
730217	39	730388	67	730561	59	730653.20	59
730221	36	730389	67	730562	59	730657	59
730225	36	730394	31	730564	66	730658	59
730227	36	730396	31	730566	67	730660	44
730230	67	730400	33	730570.320	94	730661	29
730233	66	730402	33	730570.345	94	730666	77
730235	55	730403	33	730570.620	94	730667	77
730238	44	730404	32	730570.645	94	730680	49
730238G	44	730405	32	730578.320	94	730681	48
730239	44	730406	39	730578.345	94	730682	48
730239G	44	730409	36	730578.620	94	730683	49
730243	66	730410	36	730578.645	94	730684	48
730249	53	730411	38	730579.320	94	730685	49
730249G	53	730413	40	730579.345	94	730686	49
730249G.250	53	730417	41	730579.620	94	730690	31
730250	43	730418	41	730579.645	94	730692	31
730259	32	730420	41	730585	64	730693	31
730261	33	730421	41	730586	64	730703	61
730269	32	730425	45	730593	42	730710	62
730275	45	730426	46	730594	42	730712	62
730280	30	730429	43	730595.500	64	730714	62
730288	18	730442	37	730595.1000	64	730716	62
730294	34	730443	37	730595.5000	64	730718	62

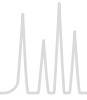

Index of reference numbers

REF	Page	REF	Page	REF	Page	REF	Page
730720	62	730915	77	731773	28	732083	45
730722	62	730931	24	731774	27	732088	46
730723	18	730931.250	24	731775	27	732091	43
730724	62	730931MPS	68	731776	27	732108	30
730726	18	730931P45	24	731801	33	732130	24
730727	26	730934	24	731802	33	732131	24
730727P45	26	730934P45	24	731803	33	732132	24
730728	28	730935	24	731804	32	732168	48
730728P45	28	730935MPS	68	731805	32	732205	43
730729	28	730935P45	24	731806	32	732210	43
730729P45	28	730936	24	731808	35	732295	34
730730	62	730936P45	24	731813	40	732472	29
730731	27	730937	24	731828	39	732482	47
730731P45	27	730938	24	731829	39	732500	67
730732	62	730938.250	24	731830	39	732501	67
730733	27	730939	24	731831	45	732681	49
730733P45	27	730939.250	24	731832	45	732800	75
730734	62	730939MPS	68	731833	45	732801	75
730735	27	730940	24	731834	46	732802	75
730735P45	27	730941	24	731835	46	732803	75
730736	62	730950	26	731836	46	732804	75
730737	27	730950P45	26	731839	30	732805	75
730738	62	730951	26	731840	30	732806	75
730739	27	730951P45	26	731841	30	732807	75
730739P45	27	730952	25	731844	43	732808	75
730740	62	730952P45	25	731845	43	732809	75
730741	27	730953	25	731848	44	732810	75
730742	62	730954	26	731849	44	732811	75
730743	27	730955	25	731851	44	732812	75
730744	28	730956	25	731852	61	732813	75
730745	28	730956P45	25	731853	61	732814	75
730747	28	730957	25	731854	61	732815	75
730747P45	28	730958	26	731860	31	732816	75
730748	28	730966	26	731861	31	732817	75
730748P45	28	730968	26	731862	31	732818	75
730749	28	730968P45	26	731863	31	732819	75
730751	29	730969	25	731865	31	732850	75
730752	29	730969P45	25	731866	31	732903	78
730753	29	730970	59	731867	31	732960	76
730754	29	730971	59	731868	31	732961	76
730754.250	29	730972	59	731870	31	732962	76
730755	29	730973	59	731871	31	732963	76
730755.250	29	730974	59	731875	31	732964	76
730756	29	730975	59	731877	31	732965	76
730757	29	730990	66	731883	18	732966	76
730758	29	730996.2	59	731884	18	732967	76
730759	29	731730	34	731885	18	732980	76
730765	31	731731	34	731886	18	732980FE	76
730798	78	731732	34	731888	18	732981	76
730880	77	731740	36	731909	31	732981FE	76
730881	77	731741	36	732002	33	732982	76
730884	77	731755	25	732012	32	732982FE	76
730885	77	731756	25	732013	32	732983	76
730886	77	731757	25	732019	67	732983FE	76
730887	77	731768	26	732020	67	732984	76
730888	77	731769	26	732023	35	732984FE	76
730890	77	731770	26	732033	40	732985	76
730891	77	731771	28	732072	39	732985FE	76
730892	77	731772	28	732073	39	732986	76

Index of reference numbers

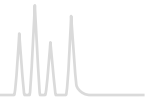

REF	Page	REF	Page	REF	Page	REF	Page
732986FE	76	738141.100M	45	760035.46	183	760081.30	160
732987	76	738161.100M	48	760046.46	182	760081.40	160
732987FE	76	738251.100M	43	760050.20	182	760081.46	160
733110.25	351	738252.100M	43	760050.30	182	760082.20	160
733110.50	351	738253.100M	43	760050.40	182	760082.30	160
733111.10	341, 351	738294.100M	34	760050.46	182	760082.40	160
733299.25	351	738520.025M	29	760051.20	182	760082.46	160
733299.50	351	738520.050M	29	760051.30	182	760083.20	160
733442.50	351	738520.100M	29	760051.40	182	760083.30	160
733551.25	351	738530.010M	24	760051.46	182	760083.40	160
735111	113, 134	738530.025M	24	760052.20	182	760083.46	160
735113	118, 134	738530.050M	24	760052.30	182	760084.20	160
735120	128, 134	738530.100M	24	760052.40	182	760084.30	160
735126	101, 134	738630.M	70, 95	760052.46	182	760084.40	160
735132	128, 134	738637	70	760053.20	182	760084.46	160
735133	118, 134	738638	70	760053.30	182	760086.46	160
735208	101, 134	738639.M	70	760053.40	182	760100.20	161
735211	113, 134	738645	70	760053.46	182	760100.30	161
735220	128, 134	738650.5	70	760054.20	182	760100.40	161
735311	113, 134	738651	70	760054.30	182	760100.46	161
735320	128, 134	738652	70	760054.40	182	760101.20	161
735408	101, 134	738655.2M	95	760054.46	182	760101.30	161
735500	113, 128, 135	738655.M	95	760059.20	183	760101.40	161
735501	113, 128, 135	738656.M	95	760059.30	183	760101.46	161
735511	113, 135	738657.M	95	760059.40	183	760102.20	161
735520	128, 135	738658.M	95	760059.46	183	760102.30	161
735611	113, 135	738659.M	95	760060.20	183	760102.40	161
735620	128, 135	738660.M	95	760060.30	183	760102.46	161
735700	113, 128, 135	738661.M	95	760060.40	183	760103.20	161
735711	113, 135	738662.M	95	760060.46	183	760103.30	161
735720	128, 135	738663.M	95	760061.46	183	760103.40	161
735811	113, 135	738680.100M	49	760062.20	183	760103.46	161
735820	128, 135	738702.030M	61	760062.30	183	760104.20	161
735911	113, 134	738770.M	95	760062.40	183	760104.30	161
735911.20	113, 128, 134	738771.M	95	760062.46	183	760104.40	161
735913	118, 134	760001.20	183	760063.20	183	760104.46	161
735920	128, 134	760001.30	183	760063.30	183	760106.46	161
736400.40	239	760001.40	183	760063.40	183	760149.40	187
736596.40	239	760001.46	183	760063.46	183	760149.46	187
736597.100	239	760002.20	183	760064.46	183	760150.40	187
736598	239	760002.30	183	760071.20	160	760150.46	187
736599.100	239	760002.40	183	760075.20	160	760151.40	187
736601	239	760002.46	183	760076.20	160	760151.46	187
736602.100	239	760004.20	183	760076.30	160	760152.40	187
738001.025M	33	760004.30	183	760076.40	160	760152.46	187
738001.100M	33	760004.40	183	760076.46	160	760153.40	187
738011.025M	32	760004.46	183	760078.20	160	760153.46	187
738011.050M	32	760007.40	190	760078.30	160	760154.46	187
738011.100M	32	760007.46	190	760078.40	160	760156.40	187
738021.100M	35	760008.20	183	760078.46	160	760156.46	187
738031.100M	40	760008.30	183	760079.20	160	760157.20	187
738071.100M	39	760008.40	183	760079.30	160	760157.30	187
738101.100M	46	760008.46	183	760079.40	160	760159.20	187
738111.100M	30	760012.46	190	760079.46	160	760170.46	190
738131.150M	64	760013.20	183	760080.20	160	760172.46	190
		760013.30	183	760080.30	160	760173.46	190
		760013.40	183	760080.40	160	760183.20	242
		760013.46	183	760080.46	160	760183.30	242
		760023.46	190	760081.20	160	760183.40	242

Index of reference numbers

REF	Page	REF	Page	REF	Page	REF	Page
760183.46	242	760262.20	167	760316.40	180	760410.30	165
760184.20	242	760262.30	167	760316.46	180	760410.40	165
760184.30	242	760262.40	167	760321.20	179	760410.46	165
760184.40	242	760262.46	167	760321.30	179	760412.20	165
760184.46	242	760263.20	167	760321.40	179	760412.30	165
760185.20	242	760263.30	167	760321.46	179	760412.40	165
760185.30	242	760263.40	167	760322.46	179	760412.46	165
760185.40	242	760263.46	167	760323.20	179	760413.20	165
760185.46	242	760264.20	167	760323.30	179	760413.30	165
760186.20	242	760264.30	167	760323.40	179	760413.40	165
760186.30	242	760264.40	167	760323.46	179	760413.46	165
760186.40	242	760264.46	167	760324.20	179	760414.20	165
760186.46	242	760271.20	167	760324.30	179	760414.30	165
760193.20	242	760271.30	167	760324.40	179	760414.40	165
760193.30	242	760271.40	167	760324.46	179	760414.46	165
760193.40	242	760271.46	167	760325.20	179	760415.20	165
760193.46	242	760272.20	167	760325.30	179	760415.30	165
760194.20	242	760272.30	167	760325.40	179	760415.40	165
760194.30	242	760272.40	167	760325.46	179	760415.46	165
760194.40	242	760272.46	167	760326.20	179	760416.46	165
760194.46	242	760273.20	167	760326.30	179	760431.20	175
760195.20	242	760273.30	167	760326.40	179	760431.30	175
760195.30	242	760273.40	167	760326.46	179	760431.40	175
760195.40	242	760273.46	167	760396.20	165	760431.46	175
760195.46	242	760274.20	167	760397.46	165	760433.20	175
760196.20	242	760275.20	167	760400.20	165	760433.30	175
760196.30	242	760301.20	179	760400.30	165	760433.40	175
760196.40	242	760301.30	179	760400.40	165	760433.46	175
760196.46	242	760301.40	179	760400.46	165	760435.20	175
760200.20	167	760301.46	179	760401.20	165	760436.20	175
760200.30	167	760304.20	179	760401.30	165	760436.30	175
760200.40	167	760305.20	179	760401.40	165	760436.40	175
760200.46	167	760305.30	179	760401.46	165	760436.46	175
760201.20	167	760305.40	179	760402.20	165	760438.20	175
760201.30	167	760305.46	179	760402.30	165	760443.20	175
760201.40	167	760306.20	179	760402.40	165	760443.30	175
760201.46	167	760306.30	179	760402.46	165	760443.40	175
760202.20	167	760306.40	179	760403.20	165	760443.46	175
760202.30	167	760306.46	179	760403.30	165	760445.46	175
760202.40	167	760308.20	179	760403.40	165	760446.20	175
760202.46	167	760311.20	180	760403.46	165	760446.30	175
760203.20	167	760311.30	180	760404.20	165	760446.40	175
760203.30	167	760311.40	180	760404.30	165	760446.46	175
760203.40	167	760311.46	180	760404.40	165	760447.20	175
760203.46	167	760312.46	180	760404.46	165	760447.30	175
760204.20	167	760313.20	180	760405.20	165	760447.40	175
760204.30	167	760313.30	180	760405.30	165	760447.46	175
760204.40	167	760313.40	180	760405.40	165	760448.20	175
760204.46	167	760313.46	180	760405.46	165	760448.30	175
760205.46	167	760314.20	180	760406.20	165	760448.40	175
760259.46	167	760314.30	180	760406.30	165	760448.46	175
760260.20	167	760314.40	180	760406.40	165	760449.20	175
760260.30	167	760314.46	180	760406.46	165	760449.30	175
760260.40	167	760315.20	180	760407.20	165	760449.40	175
760260.46	167	760315.30	180	760407.30	165	760449.46	175
760261.20	167	760315.40	180	760407.40	165	760453.20	175
760261.30	167	760315.46	180	760407.46	165	760453.30	175
760261.40	167	760316.20	180	760409.20	165	760453.40	175
760261.46	167	760316.30	180	760410.20	165	760453.46	175

Index of reference numbers

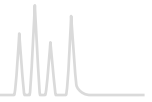

REF	Page	REF	Page	REF	Page	REF	Page
760455.46	175	760486.40	169	760552.46	185	760588.40	171
760456.20	175	760486.46	169	760553.20	185	760588.46	171
760456.30	175	760487.20	169	760553.30	185	760589.20	171
760456.40	175	760487.30	169	760553.40	185	760589.30	171
760456.46	175	760487.40	169	760553.46	185	760589.40	171
760457.20	175	760487.46	169	760554.20	185	760589.46	171
760457.30	175	760488.20	169	760554.30	185	760591.20	163
760457.40	175	760488.30	169	760554.40	185	760591.30	163
760457.46	175	760488.40	169	760554.46	185	760591.40	163
760458.20	175	760488.46	169	760561.20	171	760591.46	163
760458.30	175	760489.20	169	760561.30	171	760593.20	163
760458.40	175	760489.30	169	760561.40	171	760593.30	163
760458.46	175	760489.40	169	760561.46	171	760593.40	163
760459.20	175	760489.46	169	760563.20	171	760593.46	163
760459.30	175	760521.20	185	760563.30	171	760595.20	163
760459.40	175	760521.30	185	760563.40	171	760596.20	163
760459.46	175	760521.40	185	760563.46	171	760596.30	163
760461.20	169	760521.46	185	760565.20	171	760596.40	163
760461.30	169	760523.20	185	760566.20	171	760596.46	163
760461.40	169	760523.30	185	760566.30	171	760598.20	163
760461.46	169	760523.40	185	760566.40	171	760603.20	163
760463.20	169	760523.46	185	760566.46	171	760603.30	163
760463.30	169	760525.20	185	760568.20	171	760603.40	163
760463.40	169	760526.20	185	760573.20	171	760603.46	163
760463.46	169	760526.30	185	760573.30	171	760605.46	163
760465.20	169	760526.40	185	760573.40	171	760606.20	163
760466.20	169	760526.46	185	760573.46	171	760606.30	163
760466.30	169	760528.20	185	760575.46	171	760606.40	163
760466.40	169	760530.20	185	760576.20	171	760606.46	163
760466.46	169	760530.30	185	760576.30	171	760607.20	163
760468.20	169	760530.40	185	760576.40	171	760607.30	163
760473.20	169	760530.46	185	760576.46	171	760607.40	163
760473.30	169	760531.20	185	760577.20	171	760607.46	163
760473.40	169	760531.30	185	760577.30	171	760608.20	163
760473.46	169	760531.40	185	760577.40	171	760608.30	163
760475.46	169	760531.46	185	760577.46	171	760608.40	163
760476.20	169	760532.20	185	760578.20	171	760608.46	163
760476.30	169	760532.30	185	760578.30	171	760609.20	163
760476.40	169	760532.40	185	760578.40	171	760609.30	163
760476.46	169	760532.46	185	760578.46	171	760609.40	163
760477.20	169	760533.20	185	760579.20	171	760609.46	163
760477.30	169	760533.30	185	760579.30	171	760613.20	163
760477.40	169	760533.40	185	760579.40	171	760613.30	163
760477.46	169	760533.46	185	760579.46	171	760613.40	163
760478.20	169	760534.20	185	760583.20	171	760613.46	163
760478.30	169	760534.30	185	760583.30	171	760615.46	163
760478.40	169	760534.40	185	760583.40	171	760616.20	163
760478.46	169	760534.46	185	760583.46	171	760616.30	163
760479.20	169	760550.20	185	760585.46	171	760616.40	163
760479.30	169	760550.30	185	760586.20	171	760616.46	163
760479.40	169	760550.40	185	760586.30	171	760617.20	163
760479.46	169	760550.46	185	760586.40	171	760617.30	163
760483.20	169	760551.20	185	760586.46	171	760617.40	163
760483.30	169	760551.30	185	760587.20	171	760617.46	163
760483.40	169	760551.40	185	760587.30	171	760618.20	163
760483.46	169	760551.46	185	760587.40	171	760618.30	163
760485.46	169	760552.20	185	760587.46	171	760618.40	163
760486.20	169	760552.30	185	760588.20	171	760618.46	163
760486.30	169	760552.40	185	760588.30	171	760619.20	163

Index of reference numbers

REF	Page	REF	Page	REF	Page	REF	Page
760619.30	163	760739.46	189	760802.30	177	761910.20	165
760619.40	163	760740.20	189	760802.40	177	761910.30	165
760619.46	163	760741.20	189	760802.46	177	761911.20	165
760620.20	173	760742.46	189	760803.20	177	761911.30	165
760620.30	173	760749.46	161	760803.30	177	761912.20	165
760620.40	173	760750.20	161	760803.40	177	761912.30	165
760620.46	173	760750.30	161	760803.46	177	761915.20	167
760621.20	173	760750.40	161	760805.20	177	761915.30	167
760621.30	173	760750.46	161	760805.30	177	761916.20	167
760621.40	173	760751.20	161	760805.40	177	761916.30	167
760621.46	173	760751.30	161	760805.46	177	761917.20	167
760622.20	173	760751.40	161	760806.20	177	761917.30	167
760622.30	173	760751.46	161	760806.30	177	761920.20	177
760622.40	173	760752.20	161	760806.40	177	761920.30	177
760622.46	173	760752.30	161	760806.46	177	761921.20	177
760623.20	173	760752.40	161	760807.20	177	761921.30	177
760623.30	173	760752.46	161	760807.30	177	761922.20	177
760623.40	173	760753.20	161	760807.40	177	761922.30	177
760623.46	173	760753.30	161	760807.46	177	761925.20	179
760624.20	173	760753.40	161	760808.20	177	761925.30	179
760624.30	173	760753.46	161	760808.30	177	761926.20	179
760624.40	173	760754.20	161	760808.40	177	761926.30	179
760624.46	173	760754.30	161	760808.46	177	761927.20	180
760625.20	173	760754.40	161	760809.20	177	761927.30	180
760625.30	173	760754.46	161	760809.30	177	761931.20	182
760625.40	173	760755.20	161	760809.40	177	761931.30	182
760625.46	173	760755.30	161	760809.46	177	761932.20	183
760700.20	183	760755.40	161	760812.20	177	761932.30	183
760700.30	183	760755.46	161	760812.30	177	761936.20	183
760700.40	183	760756.20	161	760812.40	177	761936.30	183
760700.46	183	760756.30	161	760812.46	177	761937.20	183
760701.20	183	760756.40	161	760813.46	177	761937.30	183
760701.30	183	760756.46	161	760815.46	177	761941.20	187
760701.40	183	760757.20	161	760821.20	177	761941.30	187
760701.46	183	760757.30	161	760821.30	177	761943.30	187
760702.46	183	760757.40	161	760821.40	177	761944.30	187
760703.20	183	760757.46	161	760821.46	177	761951.20	189
760703.30	183	760759.20	161	760822.20	177	761951.30	189
760703.40	183	760760.20	161	760822.30	177	761952.30	189
760703.46	183	760773.20	227	760822.40	177	761953.20	189
760704.20	183	760773.30	227	760822.46	177	761953.30	189
760704.30	183	760773.40	227	760823.20	177	761960.20	185
760704.40	183	760783.30	227	760823.30	177	761960.30	185
760704.46	183	760783.40	227	760823.40	177	761961.20	185
760706.46	183	760784.30	227	760823.46	177	761961.30	185
760720.40	189	760784.40	227	760824.20	177	761962.20	185
760720.46	189	760785.30	227	760825.20	177	761962.30	185
760721.46	189	760785.40	227	761810.20	173	761966.30	190
760722.40	189	760786.30	227	761810.30	173	761967.30	190
760722.46	189	760786.40	227	761901.20	160	761970.20	227
760730.20	189	760800.20	177	761901.30	160	761970.30	227
760730.30	189	760800.30	177	761902.20	160	761971.30	227
760730.40	189	760800.40	177	761902.30	160	761975.20	175
760730.46	189	760800.46	177	761903.20	161	761975.30	175
760731.46	189	760801.20	177	761903.30	161	761976.20	175
760732.20	189	760801.30	177	761905.20	161	761976.30	175
760732.30	189	760801.40	177	761905.30	161	761977.20	175
760732.40	189	760801.46	177	761907.20	161	761977.30	175
760732.46	189	760802.20	177	761907.30	161	761980.20	169

Index of reference numbers

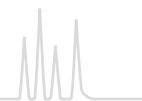

REF	Page	REF	Page	REF	Page	REF	Page
761980.30	169	762081.210	161	762273.210	167	762556.320	180
761981.20	169	762082.210	161	762291.160	167	762556.400	180
761981.30	169	762090.160	183	762291.80	167	762556.500	180
761982.20	169	762090.80	183	762293.320	167	762561.100	180
761982.30	169	762092.160	183	762302.100	183	762561.210	180
761985.20	171	762092.80	183	762302.210	183	762563.210	180
761985.30	171	762094.160	190	762303.400	183	762563.320	180
761986.20	171	762094.80	190	762311.320	183	762563.500	180
761986.30	171	762097.160	161	762311.500	183	762564.100	180
761987.20	171	762097.80	161	762321.320	183	762564.210	180
761987.30	171	762100.400	161	762330.320	190	762565.320	180
761988.20	242	762103.100	161	762350.100	163	762565.400	180
761988.30	242	762103.210	161	762350.210	163	762565.500	180
761989.20	242	762109.100	161	762351.100	163	762566.100	180
761989.30	242	762109.210	161	762351.210	163	762566.210	180
761990.20	163	762113.100	161	762352.400	163	762566.320	180
761990.30	163	762113.210	161	762353.100	163	762566.400	180
761991.20	163	762113.320	161	762353.210	163	762566.500	180
761991.30	163	762113.400	161	762353.320	163	762571.100	180
761992.20	163	762160.160	161	762353.400	163	762571.210	180
761992.30	163	762160.80	161	762354.160	163	762573.210	180
762003.100	183	762163.320	161	762354.80	163	762573.320	180
762003.210	183	762210.100	171, 175	762355.320	163	762573.500	180
762007.100	190	762210.210	171, 175	762371.400	177	762574.100	180
762007.210	190	762211.100	171, 175	762372.100	177	762574.210	180
762007.400	190	762211.210	171, 175	762372.210	177	762575.320	180
762010.100	183	762212.400	171, 175	762373.100	177	762575.400	180
762010.210	183	762213.100	171, 175	762373.210	177	762575.500	180
762010.320	183	762213.210	171, 175	762373.320	177	762576.100	180
762010.400	183	762213.320	171, 175	762373.400	177	762576.210	180
762010.500	183	762213.400	171, 175	762375.100	177	762576.320	180
762011.100	183	762214.160	175	762375.210	177	762576.400	180
762011.210	183	762214.80	175	762390.160	177	762576.500	180
762022.100	183	762216.320	175	762390.80	177	762591.160	180
762022.210	183	762220.100	169	762392.320	177	762591.80	180
762022.320	183	762220.210	169	762403.100	165	762592.320	180
762022.400	183	762221.100	169	762403.210	165	762592.500	180
762027.400	183	762221.210	169	762403.320	165	763132.20	201
762029.100	183	762222.400	169	762403.400	165	763132.30	201
762029.210	183	762223.100	169	762404.100	165	763132.40	201
762061.100	183	762223.210	169	762404.210	165	763132.46	201
762061.210	183	762223.320	169	762405.100	165	763134.20	201
762062.100	183	762223.400	169	762405.210	165	763134.30	201
762062.210	183	762224.160	169	762406.400	165	763134.40	201
762062.320	183	762224.80	169	762420.160	165	763134.46	201
762062.400	183	762226.320	169	762420.80	165	763136.20	201
762070.100	161	762234.160	171	762422.320	165	763136.30	201
762070.210	161	762234.80	171	762551.100	180	763136.40	201
762071.100	161	762236.320	171	762551.210	180	763136.46	201
762071.210	161	762250.210	161	762553.210	180	763138.20	201
762072.100	183	762250.400	161	762553.320	180	763138.30	201
762072.210	183	762269.400	167	762553.500	180	763152.20	201
762075.400	190	762271.100	167	762554.100	180	763152.30	201
762077.100	190	762271.210	167	762554.210	180	763152.40	201
762077.210	190	762272.100	167	762555.320	180	763152.46	201
762078.100	190	762272.210	167	762555.400	180	763154.20	201
762078.210	190	762272.320	167	762555.500	180	763154.30	201
762079.400	183	762272.400	167	762556.100	180	763154.40	201
762081.100	161	762273.100	167	762556.210	180	763154.46	201

Index of reference numbers

REF	Page	REF	Page	REF	Page	REF	Page
763156.20	201	763532.46	207	808013	289	811073	284
763156.30	201	763534.20	207	808023	289	811074	284
763156.40	201	763534.30	207	808033	289	811075	284
763156.46	201	763534.40	207	808043	289	811081	284
763157.20	201	763534.46	207	808053	289	811082	284
763157.30	201	763536.20	207	808063	289	811111	286
763157.40	201	763536.30	207	808072	289	811112	286
763157.46	201	763536.40	207	808073	289	811115	285
763158.20	201	763536.46	207	809011	276	811116	285
763158.30	201	763538.20	207	809012	276	811120	287
763232.20	203	763538.30	207	809013	276	812003	277
763232.30	203	763732.20	205	809017	276	812004	277
763232.40	203	763732.30	205	809017.200	276	812005	277
763232.46	203	763732.40	205	809020	276	812005.200	277
763234.20	203	763732.46	205	809021	276	812006	277
763234.30	203	763734.20	205	809022	276	812007	277
763234.40	203	763734.30	205	809023	276	812008	277
763234.46	203	763734.40	205	809027	276	812010	282
763236.20	203	763734.46	205	809027.200	276	812011	282
763236.30	203	763736.20	205	809028.100	276	812013	282
763236.40	203	763736.30	205	809033	292	812014	282
763236.46	203	763736.40	205	809043	292	814000	269
763238.20	203	763736.46	205	809051	276	814001	269
763238.30	203	763738.20	205	809053	276	814002	269
763252.20	203	763738.30	205	809061	276	814003	269
763252.30	203	801011	289	809063	276	814011	269
763252.40	203	801013	289	809073	276	814012	269
763252.46	203	801022	289	809083	276	814013	269
763254.20	203	801023	289	809121	276	814018	295
763254.30	203	801033	290	809122	276	814019	295
763254.40	203	801053	290	809123	276	814021	295
763254.46	203	801063	290	810012	279	814022	295
763256.20	203	801113	289	810013	279	814023	295
763256.30	203	801123	289	810022	279	814024	295
763256.40	203	802021	288	810023	279	814025	271
763256.46	203	802022	288	810043	293	814026	271
763257.20	203	802023	288	810053	293	814027	271
763257.30	203	803012	290	810063	292	814028	271
763257.40	203	803013	290	810123	279	814029	269
763257.46	203	803022	290	811011	281	814030	295
763258.20	203	803023	290	811012	281	814100	271
763258.30	203	804022	291	811013	281	814101	295
763332.20	209	804023	291	811021	281	814102	295
763332.30	209	805012	276	811022	281	814103	295
763332.40	209	805013	276	811023	281	814104	295
763332.46	209	805014	276	811032	279	814200	271
763334.20	209	805017	276	811042	279	814201	271
763334.30	209	805021	276	811051	292	814202	271
763334.40	209	805022	276	811052	283	814203	296
763334.46	209	805023	276	811054	283	814204	271
763336.20	209	805024	276	811055	291	814205	271
763336.30	209	805032	276	811056	291	814206	296
763336.40	209	805901	276	811057	291	814300	271
763336.46	209	805902	276	811058	291	814301	271
763338.20	209	806013	293	811059	291	814302	296
763338.30	209	806023	293	811062	283	814400	271
763532.20	207	807021	288	811064	283	814401	296
763532.30	207	807023	288	811071	284	814402	296
763532.40	207	807033	288	811072	284	814403	296

Index of reference numbers

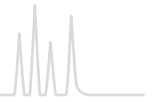

REF	Page	REF	Page	REF	Page
814404	296	815410.1	260	818131	276
814405	271	815430.1	260	818132	276
814406	271	815510.1	261	818133	276
814407	271	815510.5	261	818141	281
814919	296	815530.1	261	818143	281
814920	296	815530.5	261	818144	284
814921	296	815540.1	261	818145	284
814922	296	815540.5	261	818146	284
814923	296	815550.1	261	818147	284
815010.1	260	815550.5	261	818152	284
815010.25	260	815560.1	261	818153	289
815010.5	260	815560.5	261	818155	289
815020.1	260	815600.1	262	818156	289
815020.25	260	815600.5	262	818157	289
815020.5	260	815610.1	262	818160	276
815030.1	260	815610.5	262	818161	276
815030.25	260	815620.1	262	818162	276
815030.5	260	815620.5	262	818163	276
815050.1	262	815650.1	260	818171	284
815050.25	262	815650.25	260	818182	286
815050.5	262	815650.5	260	818184	285
815060.1	262	815710.1	261	818230.20	275
815060.25	262	815710.5	261	818232	275
815060.5	262	816250.1	297	818233	275
815070.1	262	816250.5	297	818240	281
815300.1	260	816310.1	297	818241	281
815300.25	260	816310.5	297	818261	275
815300.5	260	816320.1	297	818329	275
815310.1	260	816320.5	297	818330.20	275
815310.25	260	816330.1	297	818331	275
815310.5	260	816330.5	297	818332	275
815320.1	260	816340.1	297	818333	275
815320.25	260	816340.5	297	818342	281
815320.5	260	816380.1	297	818343	281
815330.1	260	816380.5	297	818360	275
815330.25	260	816400.1	297	818362	275
815330.5	260	816400.5	297	818412	279
815340.1	260	816410.1	297	818413	279
815340.25	260	816410.5	297	818422	279
815340.5	260	816610.1	297	818423	279
815350.1	260	816620.1	297	818432	279
815350.25	260	816710.01	296	818442	279
815350.5	260	816720.01	296	818666	295
815360.1	260	817001	294	821005	274
815360.25	260	817002	294	821010	274
815360.5	260	817003	294	821010.200	274
815380.1	260	817004	294	821015	274
815380.25	260	817005	294	821020	274
815380.5	260	817006	294	821025	274
815381.1	260	817007	294	821030	274
815381.25	260	817008	294	821040	274
815381.5	260	818023	288	821040.200	274
815390.1	260	818024	288	821050	274
815390.25	260	818030.20	276	821060	274
815390.5	260	818032	276	821110	281
815400.1	260	818033	276	821120	281
815400.25	260	818129	276	821140	281
815400.5	260	818130.20	276	821150	281

%C	carbon content in percent	LV	large volume
Å	angstrom = 0.1 nm = 1.0×10^{-10} m	MPS	CHROMABOND® SPE cartridges for MultiPurposeSampler
ACN	acetonitrile	MS	mass spectrometry (suitable)
Alox	aluminum oxide	MTBE	methyl <i>tert</i> -butyl ether
AOX	sum parameter for adsorbable organic bounded halogens	N	e.g., N 11, identified the nominal diameter of a bottle neck, an insert, a closure or a septum
ASP	CHROMABOND® SPE cartridges for ASPEC systems	nm	nanometer = 1.0×10^{-9} m
BDS	base deactivated octadecylsilan (C ₁₈)	NP	normal phase
BET	analytical methods for determining of surfaces size (developer: Stephen Brunauer, Paul Hugh Emmett and Edward Teller)	OD	outer diameter
BTEX	aromatic hydrocarbons: benzene, toluene, ethyl benzene and xylene	ODS	octadecylsilan (C ₁₈)
BTX	sum parameter for volatile aromatic hydrocarbons	PA	polyamide, nylon
DIN	German Institute for Standardization	PAH	polycyclic aromatic hydrocarbons
DMA	dimethylamino = N(CH ₃) ₂	PCA	propylcarboxylic acid also butyric acid
DOC	dissolved organic carbon	PCB	polychlorinated biphenyls
DVB	divinylbenzene copolymer	PE	polyethylene
EC	column hardware for analytical columns in HPLC	PEEK	polyether ether ketone
ec	endcapping or endcapped	PEG	polyethylene glycol
EP	European Pharmacopoeia (Ph. Eur., PharmEurl., etc.)	PEI	polyethylenimin
EPA	US Environmental Protection Agency	PL	phospholipids
ETFE	ethylene tetrafluoroethylene	PP	polypropylene
F217	gasket material (foamed polyethylene between two solid polyethylene layers)	ppb	parts per billion (1 per 1000000000 = 10 ⁻⁹)
FEP	fluorinated ethylene propylene	ppm	parts per million (1 per 1000000 = 10 ⁻⁶)
FID	flame ionization detector	PS/DVB	polystyrene divinylbenzene copolymer
FS	fused silica	PSA	propylsulfonic acid
GC	gas chromatography	PTFE	polytetrafluoroethylene
HEPT	height equivalent to a theoretical plate	REF	reference number, article number, product number, ordering number
HILIC	hydrophylic interaction chromatography	RI	refractive index
HPLC	high performance liquid chromatography	RP	reversed phase
HPTLC	high performance thin layer chromatography	SA	strong acidic, also see SCX
HS	headspace	SAX	strong anion-exchanger
ID	internal diameter	SB	strong basic, also see SAX
IR	infrared spectroscopy, spectral range	SCX	strong cation-exchanger
ISO	International Organization for Standardization	SiOH	silanol, unmodified silica
		SPE	solid phase extraction

List of abbreviations

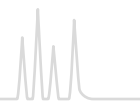

SPME	solid phase micro extraction
TEF	Tefzel [®] , see ETFE
TFA	trifluoroacetic acid
THC	tetrahydrocannabinol
THF	tetrahydrofuran
TLC	thin layer chromatography
TOC	total organic carbon
UHPLC	ultra HPLC, high separation performance by < 2 μ m particles or core-shell technology
UPLC	see UHPLC, but protected term of the company Waters Corporation (USA)
USP	United States Pharmacopeia
UV	ultraviolet wavelength range (e.g., 254 nm), spectral range
VOC	volatile organic compounds
VP	column hardware for preparative columns in HPLC
WCX	weak cation-exchanger

MACHEREY-NAGEL trademarks

ALUGRAM	coated aluminium sheets for TLC
CHROMABOND	columns for solid phase extraction (SPE)
CHROMAFIL	syringe filters (membrane filters)
CHROMAFIX	cartridges for solid phase extraction (SPE)
ChromCart	cartridge system for HPLC
LIPODEX	fused silica capillary columns with cyclodextrin phases for GC enantiomer separation
NUCLEODUR	spherical high purity silica for HPLC
NUCLEOGEL	polymer-based HPLC columns
NUCLEOGEN	HPLC ion exchange columns for nucleic acid analyses
NUCLEOSHELL	core-shell silica phases for HPLC
NUCLEOSIL	spherical standard silica for HPLC
OPTIMA	fused silica high performance capillary columns with immobilized phases
OPTIMA WAXplus	fused silica high performance capillary columns with optimized polyethylene glycol phase
PERMABOND	fused silica capillary columns with immobilized phases
POLYGOSIL	irregular silica for HPLC
POLYGRAM	coated polyester sheets for TLC

Trademarks of other companies

Registered trademarks (®)

Accubond	Agilent Technologies Inc. (USA)	Gemini	Phenomenex Inc. (USA)
Acquity	Waters Corp. (USA)	Hypersil	Thermo Fisher Scientific Inc. (USA)
Agilent	Agilent Technologies Inc. (USA)	HyPurity	Thermo Fisher Scientific Inc. (USA)
Allure	Restek Corp. (USA)	Inertsil	GL Sciences (Japan)
Aqua	Phenomenex Inc. (USA)	Isco	Teledyne Isco Inc. (USA)
Ascentis	Sigma-Aldrich Co. (USA)	Isolute	Biotage AB (Sweden)
Atlantis	Waters Corp. (USA)	Kromasil	Eka Chemicals AB (Sweden)
AutoTrace	Caliper Life Sciences Inc. (USA)	LiChrolut	Merck KGaA (Germany)
AVICEL	FMC Corp. (USA)	LiChrospher	Merck KGaA (Germany)
Biomek	Beckman Coulter Inc. (USA)	Luna	Phenomenex Inc. (USA)
Biotage	Biotage AB (Sweden)	Metrohm	Deutsche Metrohm GmbH & Co. KG (Germany)
Bond Elut	Varian Inc. (USA)	Microlab	Hamilton Co. (USA)
Celite	Manville Corp. (USA)	MultiProbe	PerkinElmer Inc. (USA)
Cheminert	Valco Instruments Co. Inc. / VICI AG	Oasis	Waters Corp. (USA)
ChiralCel	Daicel Chemical Industries Ltd. (Japan)	PerkinElmer	PerkinElmer Inc. (USA)
ChiralPak	Daicel Chemical Industries Ltd. (Japan)	Polaris	Agilent Technologies Inc. (USA)
Clean Screen	UCT United Chemical Technologies Inc. (USA)	ProntoSil	Bischoff Chromatography (Germany)
CLEAN-UP	UCT United Chemical Technologies Inc. (USA)	Purospher	Merck KGaA (Germany)
CombiFlash	Teledyne Isco Inc. (USA)	Pyrex	Corning Inc. (USA)
Companion	Teledyne Isco Inc. (USA)	Quadra 3	Tomtec Inc. (USA)
Discovery	Sigma-Aldrich Co. (USA)	RapidTrace	Caliper Life Sciences Inc. (USA)
Duran	Schott AG (Germany)	Rxi	Restek Corp. (USA)
epMotion	Eppendorf AG (Germany)	Rtx	Restek Corp. (USA)
Eurocel	Knauer GmbH (Germany)	Sep-Pak	Waters Corp. (USA)
EXTrelut	Merck KGaA (Germany)	SOTAX	Sotax AG (Schweiz)
Fiolax	Schott AG (Germany)	Spherisorb	Waters Corp. (USA)
Florisil	U.S. Silica Co.	Stabilwax	Restek Corp. (USA)

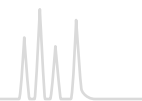

Styre Screen	UCT United Chemical Technologies Inc. (USA)	Viton	DuPont Performance Elastomers (USA)
Superspher	Merck KGaA (Germany)	Xterra	Waters Corp. (USA)
Symmetry	Waters Corp. (USA)	YMC	YMC Co. Ltd. (Japan)
Synergi	Phenomenex Inc. (USA)	ZIC	Merck Sequant AB (Sweden)
Varian	Varian Medical Systems Technologies Inc. (USA)	Zorbax	Agilent Technologies Inc. (USA)
Vespel	E. I. du Pont de Nemours & Co. (USA)	Zymark	Caliper Life Sciences Inc. (USA)
VICI	Valco Instruments Co. Inc. / VICI AG	Zymate	Caliper Life Sciences Inc. (USA)

Common law trademarks (™)

AmyCoat	Eka Chemicals AB (Sweden)	Kinetex	Phenomenex Inc. (USA)
ASPEC	Gilson Inc. (USA)	Lux	Phenomenex Inc. (USA)
AT	Alltech Associates Inc. (USA)	Obelisc	Sielc Technologies (USA)
Bakerbond	Mallinckrodt Baker Inc. (USA)	Ostro	Waters Corp. (USA)
Benchmate	Caliper Life Sciences Inc. (USA)	Nukol	Sigma-Aldrich Co. (USA)
BPX	SGE Analytical Sciences Pty Ltd. (Australia)	PEEK	Victrex plc. (UK)
Carbowax	Union Carbide Corp. (USA)	Phree	Phenomenex Inc. (USA)
CelluCoat	Eka Chemicals AB (Sweden)	Porapak	Waters Corp. (USA)
Chem Elut	Varian Inc. (USA)	Poroshell	Agilent Technologies Inc. (USA)
DB	J&W Scientific Inc. (USA)	SPB	Sigma-Aldrich Co. (USA)
Equity	Sigma-Aldrich Co. (USA)	Select	Agilent Technologies Inc. (USA)
FlashMaster	Biotage AB (Sweden)	Sequant	Merck Sequant AB (Sweden)
Flash 12i	Biotage AB (Sweden)	Strata	Phenomenex Inc. (USA)
Focus	Varian Inc. (USA)	SunFire	Waters Corp. (USA)
Genesis	Tecan Group AG	Supelclean	Sigma-Aldrich Co. (USA)
Hydromatrix	Varian Inc. (USA)	Supelcosil	Sigma-Aldrich Co. (USA)
HyperSep	Thermo Fisher Scientific Inc. (USA)	Supelcowax	Sigma-Aldrich Co. (USA)
Hypersil	Thermo Fisher Scientific Inc. (USA)	SymmetryShield	Waters Corp. (USA)
HyPURITY	Thermo Fisher Scientific Inc. (USA)		

Disclaimer

All used names and denotations can be brands, trademarks or registered labels of their respective owner – also if they do not have a special denotation. To mention products and brands is only a kind of information, i.e. it does not offend against trademarks and brands and can not be seen as a kind of recommendation or assessment.

Regarding these products or services we can not grant any guarantees regarding selection, efficiency or operation.



Product use restriction

MACHEREY-NAGEL chromatography products are intended, developed, designed and sold for research and development purposes and analytical quality control / routine measurements only, except, however, any other function of the product being expressly set forth in original MACHEREY-NAGEL product leaflets.

MACHEREY-NAGEL products are intended for general laboratory use only!

MACHEREY-NAGEL products are suited for qualified personnel only!

MACHEREY-NAGEL products shall in any event be used wearing adequate protective clothing.

For detailed information please refer to the respective Material Safety Data Sheet of the product!

MACHEREY-NAGEL products shall exclusively be used in an adequate test environment.

MACHEREY-NAGEL does not assume any responsibility for damages due to improper application, abuse, misuse, storage or maintenance of our products. Prior to application the user has to read carefully and understand the instruction or product leaflets included in the product package (if applicable or available on the webpage) - in case of any doubts the customer has to contact MACHEREY-NAGEL.

Application on the human body is STRICTLY FORBIDDEN. The respective user is liable for any and all damages resulting from such application.

The user has to ensure that the products used are suitable for the intended application.

MACHEREY-NAGEL does not warrant the reproducibility of published applications.

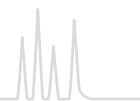

- [1] M. Anastassiades, S. J. Lehotay, D. Stajnbaher, F. J. Schenck, J. AOAC Int. 86 (2003), 412-431.
- [2] AOAC Official Method 2007.01, Pesticide Residues in Foods by Acetonitrile Extraction and Partitioning with Magnesium Sulfate.
- [3] EN 15662:2008 Foods of plant origin – Determination of pesticide residues using GC-MS and/or LC-MS/MS following acetonitrile extraction/partitioning and clean-up by dispersive SPE – QuEChERS method.
- [4] Tanaka, N. et al., Journal of Chromatographic Science, 27 (1989), 721-728.
- [5] LCGC 8 (1990) 378–390
- [6] U. D. Neue et al., Chromatographia 54 (2001), 169–177
- [7] A. Alpert, J. Chromatography 499 (1990), 177–196
- [8] C. S. Young and R. J. Weigand, LCGC 20 (2002), 464–473
- [9] V. R. Meyer, Practical High Performance Liquid Chromatography (John Wiley & Sons, New York, 3. Aufl., 1999)
- [10] J. J. Kirkland, LCGC 14 (1996), 486–500
- [11] M. W. Beyerinck, Z. Phys. Chem. 3 (1889), 110
- [12] Dünnschicht-Chromatographie, 2. Auflage, Springer-Verlag Berlin, 1967
- [13] H. Jork, Laborpraxis 2 (1992), 110
- [14] “Proceedings of the International Symposium on Instrumental TLC”, Brighton, Sussex, UK 1989, 105–114
- [15] H. Jork et al., Dünnschicht-Chromatographie, VCH Verlagsgesellschaft, 1989
- [16] Planar Chromatography, Vol. 1, ed. R. E. Kaiser, Dr. Alfred Hüthig Verlag, Heidelberg, 1986
- [17] J. Sullivan, L. Schewe, J. Chromatogr. Sci. 15 (1977), 196–197
- [18] W. Butte, J. Chromatogr. 261 (1983), 142
- [19] Thenot et al., Anal. Letters 5 (1972), 217–223, 519–529
- [20] M. Donike, J. Chromatogr. 85 (1973), 1–7

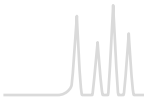

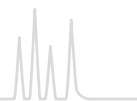

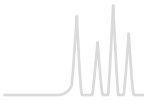

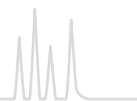

Distributed By



Greyhound Chromatography and Allied Chemicals
6 Kelvin Park
Birkenhead
Merseyside, CH41 1LT

Tel: 0151 649 4000 Fax: 0151 649 4001
Email: info@greyhoundchrom.com
Web: <https://www.greyhoundchrom.com>

www.mn-net.com

MACHERY-NAGEL

